

THOY 

Model Rocket Kit

CLURO'S

Length 23.125"
Diameter 1.00"
Weight 1.8oz.

Motors: single stage configuration: A8-3 (first flight), B6-4, C6-5; two stage configuration: first stage: B6-0 (first flight), C6-0, second stage: A8-5 (first flight), B4-6, B6-6, C6-7.

Estimated Maximum Altitude: 1800 feet

Recommended for ages 10 through adult. Adult supervision for ages twelve and under.

Not included in this kit: finishing supplies, glue, engines, model knife, and launch equipment



SKILL
LEVEL
3



THOY 

CLUROS

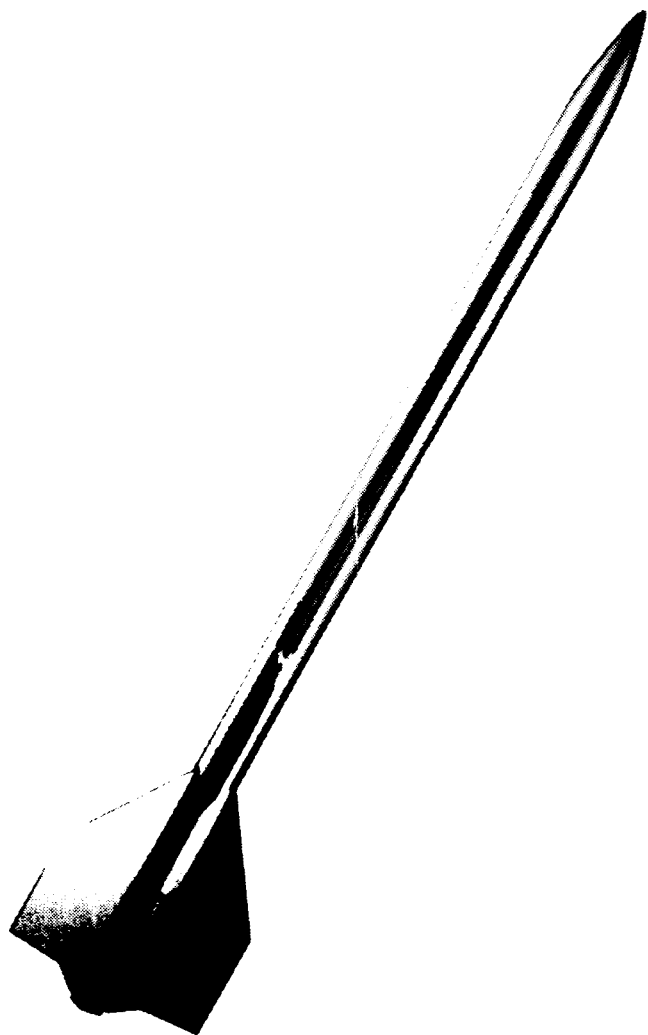

The THOY Cluros is a high flying two stage model rocket. This rocket is designed to be flown only from a standard model rocket launcher with a 1/8" launch rod and an electrical launch control system. Please follow the model rocketeer's safety code thereby making the hobby safe and enjoyable for everyone. The Cluros may be flown as a single-stage rocket also.

Parts List

- | | | |
|---------------------------------|-------------------------------|------------------------|
| (1) Nose cone | (1) Body tube | (2) Motor mount tubes |
| (4) Motor mount centering rings | (1) Motor block | (1) Launch lug |
| (1) Shock cord | (1) 16" Parachute | (1) Shock cord mount |
| (1) Stage coupler | (1) 12" Balsa Sheet fin stock | (1) Fin template sheet |

Tools Needed For Assembly

- | | | |
|----------------------------|-----------------------|--------|
| Cyanoacrylate or Wood Glue | Sanding Sealer | Ruler |
| Modeling Knife | Sandpaper (220 - 400) | Pencil |
| Scissors | Masking tape | |

ASSEMBLY

Note: Throughout these instructions are references to using a double glue joint to connect parts to one another. A double glue joint is stronger than just applying glue to one surface and holding it against the other until it sets up. It also sets up faster allowing quicker construction time. Proceed as follows; when the surfaces to be joined are ready, apply a thin layer of wood glue to both mating surfaces. Smooth the glue out with your finger. When that layer has dried completely apply another thin layer and connect the parts. The parts should hold together within a minute and dry quickly enough to move on to the next step. These joints are not normally strong enough on their own and should be reinforced with fillets. **This procedure does not apply if you are using cyanoacrylate where you should follow the manufacturers instructions.**

- 1) **Booster motor mount:** Take two centering rings and glue each ring 1/2" from opposite ends of one of the motor tubes. Upper stage motor mount: Take the remaining two centering rings, motor tube, and motor block. Glue one ring 3/4" from one end and the other flush on the other end. Glue the motor block flush inside the end with the flush centering ring.

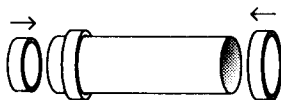

- 2) Apply a generous amount of glue to the inside of the 2 3/4" body tube. Insert the booster motor mount until 1/4" of the motor tube is exposed from the rear of the tube.

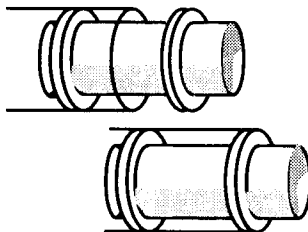

- 3) Mark the middle of the stage coupler and glue it into the upper end of the booster tube up to the mark.



- 4) Fill the body tube seams if desired. Lightly sand tubes with #400 sandpaper. This helps create stronger glue joints and a better surface for paint to adhere to.



5) Use the fin alignment guide to mark the fin and launch lug positions on the longer body tube. Connect the booster tube to the upper stage. Use small strips of masking tape if necessary to keep the tubes together and straight. Extend the lines on the body tube $2\frac{3}{4}$ " and the entire length of the booster using a ruler or door jamb. Make the launch lug line extend the entire length of the upper stage.

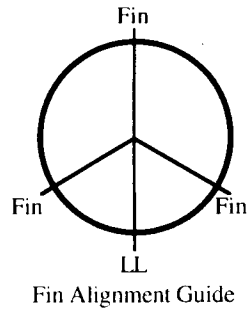

6) Apply a generous amount of glue to the inside of the rear of the upper stage tube. Insert the upper stage motor mount, motor block end first and use the booster to push it in to the correct position. Remove the booster immediately so it does not become stuck to the upper stage.

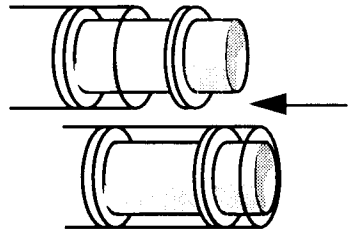

7) Cut out the fin templates and trace copies onto the balsa sheet according to the diagram. Cut out the fins carefully with a hobby knife. Hold identical fins together and sand each set until the edges are even. Tape one booster fin to an upper stage per the diagram and sand each set until the root edges are even. Only round the leading edge of the upper stage fins and the trailing edge of the booster fins.



8) Apply a thin layer of glue to root edge of the fin sets. Leave a $\frac{1}{4}$ " gap where the two fins meet. Also, apply a thin layer of glue on the fin alignment lines on the booster and upper stage tubes. Again, leave a $\frac{1}{4}$ " gap at the stage joint. Repeat the above procedure and place fins on the alignment marks. Make sure fins project straight away from the body tube.

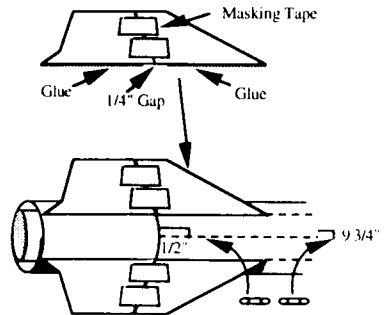

9) When the glue has dried thoroughly, remove tape and disconnect stages. Apply glue fillets to all of the fin/body tube joints. When fillets have dried, brush on sanding sealer to all wood surfaces and sand between coats until a smooth surface is achieved.

11) Cut tapers to the front and rear of each launch lug. Glue and fillet launch lugs to body tube on the launch lug line. Place one lug 1/2" from the stage coupler and the other 9-3/4" from the stage coupler.

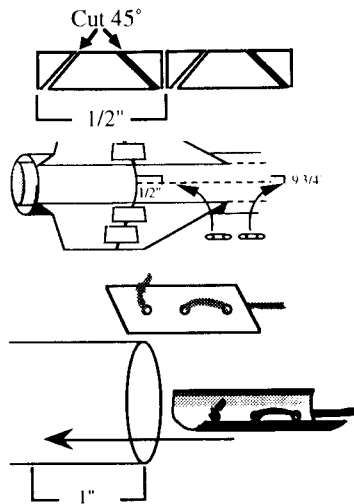

12) Thread the shock cord through the shock cord mount and tie a double knot at the end. Roll the shock cord mount so it will fit better against the inside of the body tube. Apply a thin layer of glue to the bottom of the shock cord mount and inside about 1" from the front end of the body tube. When glue has dried apply a slightly thicker layer of glue to the shock cord mount and press it into place until the glue sets.

13) Tie the other end of the shock cord to the nose cone.

14) Paint the model the colors of your choice. If the booster is to be painted separately, mask off the stage coupler.

15) Prepping the Cluros for flight: Insert 4 loosely crumpled squares of recovery wadding into the body tube. Powder the parachute with talcum powder then fold the parachute wrapping the shroud lines loosely around it and insert on top of the wadding. Pack the shock cord above the parachute and put the nose cone in place. It should fit snugly, but not too tight.

16) Hold the motors so the nozzle of the upper stage motor is on top of the booster motor. Place a single wrap of cellophane tape around the joint. Friction fit the upper stage motor. Once in place, wrap masking tape around the booster motor and slip the booster onto the motor until it is all the way forward. Twist the booster to align the fins.

17) Install an igniter per the manufacturer's instructions. Have a friend standing by to observe the booster after staging.

Parachute Assembly

- 1) Carefully cut out the parachute.
- 2) Cut shroud line into four equal lengths of 36".
- 3) Apply tape ring to the eight dots on the parachute.
- 4) With a sharp pencil, punch holes in the center of each tape ring.
- 5) Tie each end of the shroud line through each tape ring.
- 6) Attach the parachute to the nose cone.

Tiffany Hobbies of Ypsilanti

P.O. Box 467, Ypsilanti, MI 48197-0467
Phone 313-741-0847, Fax 313-484-4272



Cluros

Cluros

THOY 

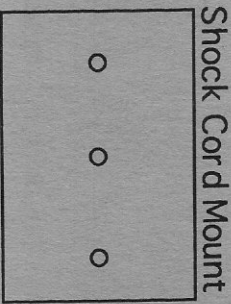
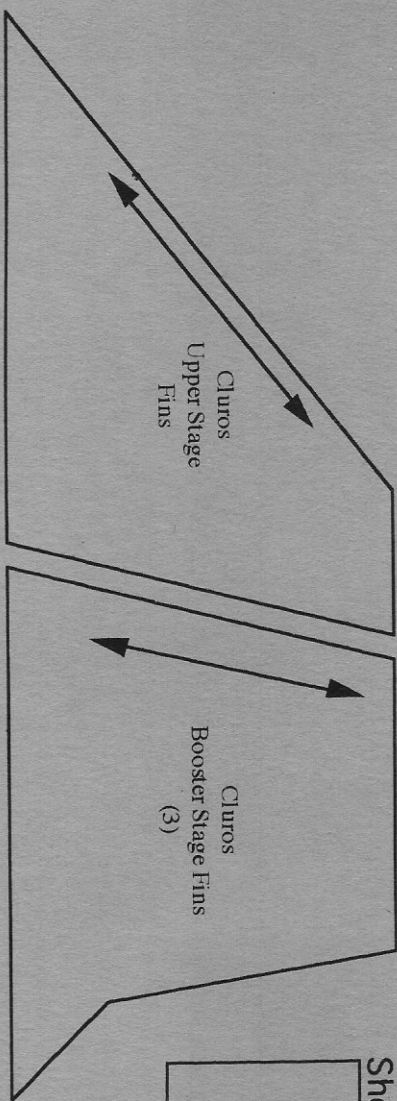
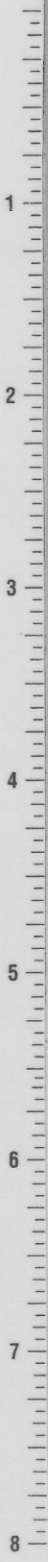

s
2
9
16
23
30
1
6
13
20
27
6
13
20
27
2
3
10
17
24
3
1
8
15
22
29
5
12
19
26
4
3
10
17
24
31
7
5
14
21
28

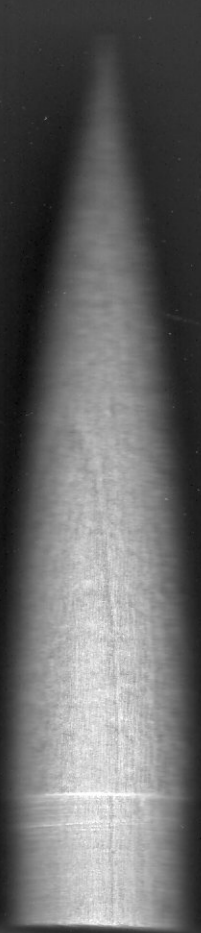

THoY Cluros Parts List

1. Nose Cone (refer to jpeg)
2. Motor mount centering rings CR2050
3. Shock cord 1/8" elastic fabric, 12" long
4. Stage coupler JT50
5. Body tube (upper stage) 15 13/16" long BT50
6. Body tube (booster) 2 3/4" long BT50
7. Motor block CR520
8. Parachute 16"
9. 12" Balsa sheet 3/32" thick
10. Motor mount tubes 2 3/4" long BT20
11. Launch lug 1" long 1/8" diameter