

This issue is dedicated to the staff and participants
of the PITTSBURGH SPRING MODEL ROCKETRY
CONVENTION.

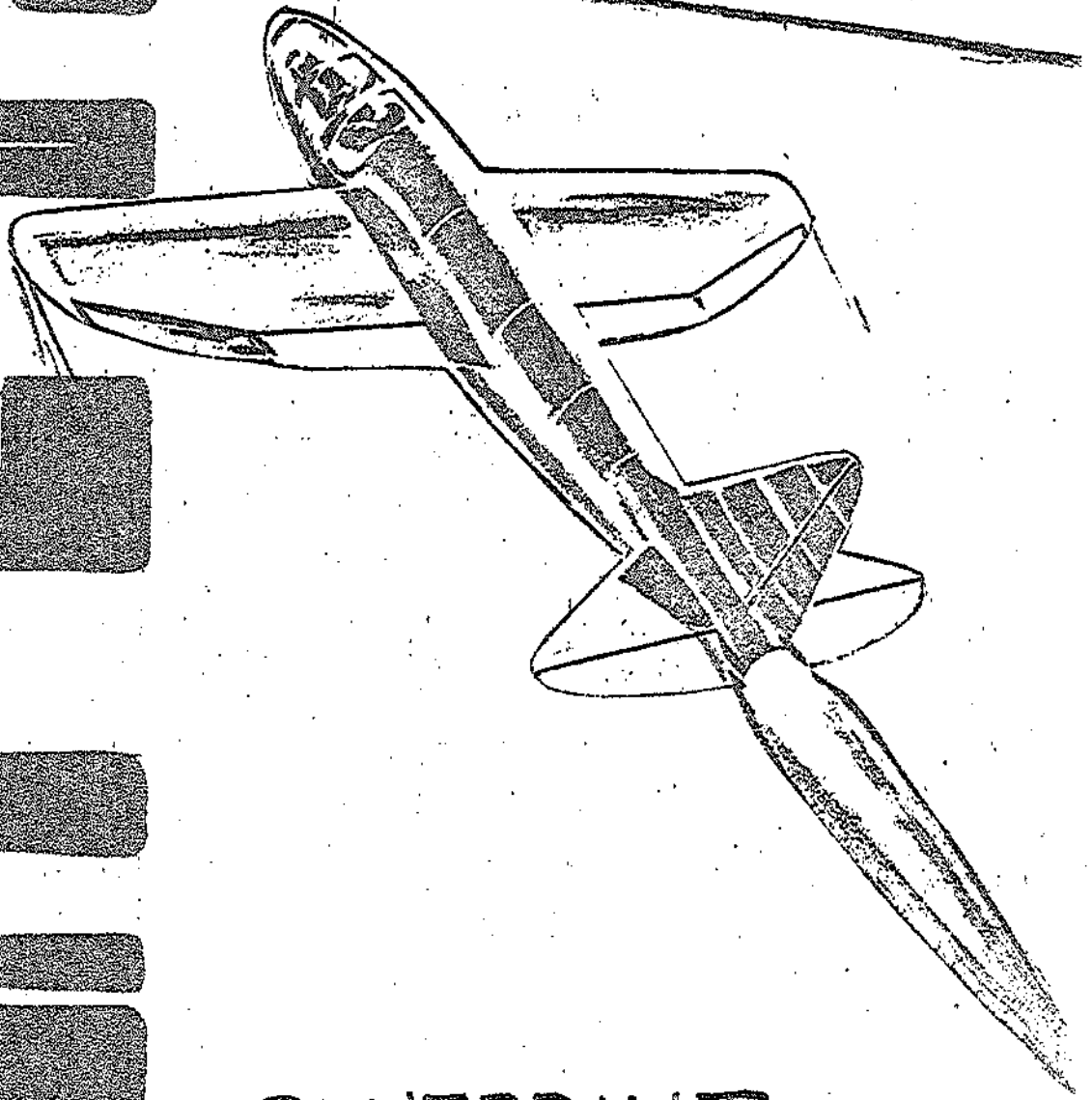

BLUEPRINT
SPECIAL - TWO
GLIDERS

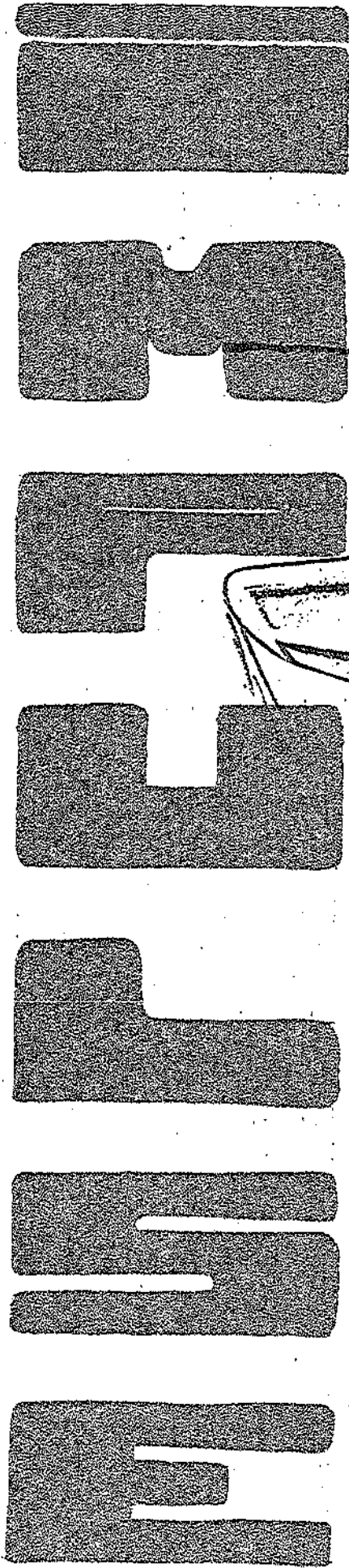



National Association of Rocketry

Post Office Box 178
McLean, Virginia 22101

a message to the members of the NAR

A new Board of Trustees has been elected, the new officers have taken their places. One of the first problems tackled by this new board, was that of the financial health of the Association. As I know you are aware, we in the Association are faced with the same rising costs affecting every group. It costs more for printing, to have a telephone, and even mail letters. Paper costs have skyrocketed as well as all services required by the Association. These rising costs have increased the cost of the Model Rocketeer magazine to you the members. To keep our association a sound, effective organization, we have been forced to increase our membership dues. The increase was kept to the smallest possible.

We must have an association with a sound financial base if we are to continue our support of both you, the member and the Model Rocketry Hobby. The NAR has a great future, many new programs are underway now. We need your continued support now and in the future if we are to have viable organization. Remember this is your association, and each member has the opportunity to make a contribution to our continued success.

A. L. Lindgren
President

Gentlemen,

Please accept this application for full membership in the National Association of Rocketry (NAR). If I am accepted in the NAR I pledge to observe and follow the NAR safety code. I am aware that a reported violation of the NAR safety code may lead to the revocation of my membership right. I also agree to abide by the by-laws and the standards and regulations of the NAR.

Signature _____

MEMBERSHIP CATEGORY (Please check one box only)

- | | | |
|--------------------------|--|----------------------|
| <input type="checkbox"/> | JUNIOR MEMBERSHIP (Under 16 as of January 1) | \$7.00 |
| <input type="checkbox"/> | LEADER MEMBERSHIP (Under 21 as of January 1) | \$8.00 |
| <input type="checkbox"/> | SENIOR MEMBERSHIP (21 or over as of January 1) | \$10.00 |
| <input type="checkbox"/> | New | |
| <input type="checkbox"/> | Renewal | |
| | NAR Number _____ | Section Number _____ |

DATE OF BIRTH _____ AMOUNT ENCLOSED _____
Month Day Year

NAME _____ DATE _____

ADDRESS (No. & Street) _____

CITY _____ STATE _____ ZIP _____

- Family Plan Membership. Deduct \$2.00 (One member of family joins at full price, remaining members at the reduced rate—one copy of Model Rocketeer per family)
- FAI Stamp \$2.00 (Required if you wish to compete on International level.)

THERE'S NOTHING AS REWARDING AS ROCKETRY

IMPULSE

The Journal of the Model Rocketry and Aeromodeler's Club

1974

Volume 3 Number 4

IMPULSE STAFF

Editor - Don Carlson
Featured Reporter -
Randy Picolet
General Assistant -
Jerry Speidel

Published through the courtesy of
Festus Senior High School.

This is an official publication of the
Model Rocketry and Aeromodeler's
Club (MORAC), NAR sanction number
305. Ideas, plans, cartoons, arti-
cles, and opinions expressed in this
publication are the sole responsibil-
ity of the Model Rocketry and Aero-
modeler's Club and do not reflect
the policy or opinion of the Festus
R-6 District

IMPULSE is a non-profit project
developed for the betterment of
model rocketry. Advertising is
sold only to defray some of the pub-
lication costs. Advertisers should
write the IMPULSE offices for in-
formation concerning advertising.

IN THIS ISSUE

Letters	4
Editorial	5
Contest News	6
Design Efficiency	7
Piston Tower	8
Trimming	10
Raid 5A	12
Clipper Conversion	14
Vulture VIII	17
Building a Winning B/G	20
MORAC News	21
Pagan 5	22
Capsule Communications	24
Tenderfoot B/G	25

1974 - IMPULSE

BLUEPRINT SPECIAL TWO

Rt. 1 Box 407, Festus, Mo., 63028

LETTERS

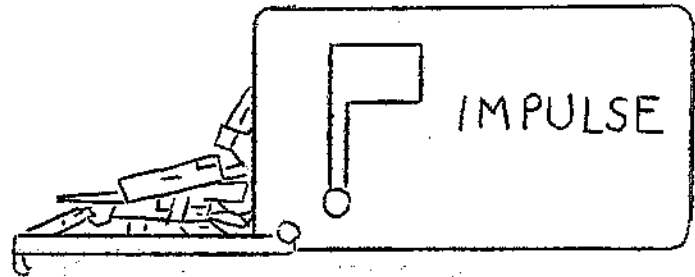

Dear Don,

... I thought that I would comment on your editorial "Living With a Decision." (Vol. 3, No. 2) I really don't want to defend the decision. I believe the Manassas site was picked because the number of people in the Houston area active in model rocketry was thought to be small (about 5 people). Also, no effort was made to contact the contest board after the NARAM, as far as I know. The distance will not help you, I know. I personally would not have minded Houston or even Kansas City (what ever happened to the [Kansas City site proposal] of the Midwest Rocket Research Association...?) NOVAAR really doesn't have the people, but can and will draw on other sections...

Sincerely,
An Eastern Rocketeer

Kansas City boasts one of the best model rocket flying fields in the country; an obsolete Naval air station. It is flat, treeless, accessible by countless runways, taxiways, and roads, and is near many motels and eating facilities. Past meets have been flown from the Olathe Naval Air Station (EKAM, HARM, etc.) and have been great successes, but, unfortunately, Olathe has become off-limits to the MRRA for 2 reasons: 1) It was (or is now) turned over to the Army for use as a helicopter base (indeed, during HARM-2 the range had to cease operations several times to give complete airspace to low flying military helicopters), thus rocket meets can't be flown on an active

military installation, and 2) Larry Loos, who was instrumental in obtaining permission to use Olathe, was transferred to England. Whether Olathe can be used again or if another site can be found in the Kansas City area is up to the MRRA. How about it, Gary? - ed.

Dear Don,

I just finished reading Volume Three, Number Three of *Impulse*. I found it very interesting as well as informative.

The article "Rocketry in the Fifties" moved me greatly because I had my start in model rocketry in 1958. I was an official in Research '58. We built rockets out of stainless steel boiler tubing and used Zinc and Sulfer as fuel. Our nozzels were hand made out of ceramic material. We had \$1000 of insurance that costs us \$100 a year. Praise God for the NAR.

Thanks for the copy of *Impulse*.

Sincerely,
Ed Bobrow
President
Glory Bound 311

Ed Bobrow has been active in rocketry for 16 years! I imagine he has quite a few interesting stories about model rocket history. Maybe he will share them with us someday. -ed.

Send all correspondence to: *IMPULSE*,
Rt. 1 Box 407, Festus, Missouri 63028

EDITORIAL

An Explanation and

A few Words About Midwest Activity

I have received several complaints about using old material in Volume Three, Number Two. Some confusion can be expected since the only indication that we were going to publish an "Impulse Special" was in the previous issue. I apologize again for the oversight and offer this explanation.

We are publishing two "Blueprint Specials" this year because; 1) our circulation has increased five-fold since NARAM-15 and only a hand full of people were able to see early copies of "Impulse." Thus, some very good designs are being exposed to an audience that did not see them, 2) the plans in the specials are clearer and of better quality than those originally published; 3) we hope to get out ten or more issues this year, and the two specials have allowed us time to organize several issues ahead, and 4) this issue in particular will be featured at the Pittsburgh Spring Model Rocket Convention and we couldn't possibly have gotten a regular issue together in time.

I promise, fans, that this is the last "Blueprint Special" this year, so take hear, read the new stuff, and wait patiently for the next issue.

I would like to say a word or two about the state of activity (or, more accurately, the state of inactivity) in the Midwest Region.

The East is busy with various

events such as MITCON, the Pittsburgh Convention, ECRM, NARAM, etc., while the heartland of America sits idly on its butt.

At this writing, I know of six events that are scheduled for the near future in the Midwest; NARGASM '74, WORM 2, SCATTER 3, ETR 4, SCARED 7, and MAR 3. No conventions, no symposiums; nothing but rocket meets.

The gas shortage is real. (Whether it is a farce or not is irrelevant since we still can't get gas.) That means that rocketry activities are going to be restricted to areas closer to our home towns.

The Urban Area Co-ordinators should get in contact with Tom Hoelle and discuss this problem. Surely some arrangements can be made to set up regular events (such as building sessions, shopping center displays, and launches) between clubs within a city.

Dave Flagg of SCARE has been working on a St. Louis Model Rocketry Symposium for quite some time. Although the plans are not complete, St. Louis is an excellent site for a symposium or convention. It is centrally located (about the same distance from Kansas City, Chicago, Indianapolis, and Memphis), accessible by road, air, rail, or raft, and has within its borders the company that built the Mercury and Gemini spacecraft, the airlock module for Skylab, and is actively pursuing a shuttle contract with NASA. McDonnell-Douglas aircraft could supply many speakers as well as tours.

There is a definite activity shortage and when clubs have an activity shortage they soon have membership shortages. C'mon Midwesterners! Let's get going!!



CONTEST NEWS

BLUE-GREY

NARGASM

RAM

HARM

WORM

NARAM

EKAM

FTR

SCATTER

JEFFCAM

SLAM

LAPR

NARGASM '74

Well, rocketry fans, MORAC will try their hands again at holding a meet. Those of us who survived JEFFCAM-1 thought that never again would the idea come up, but the urgings of certain club members (hi, Keith) have pressured the rest of the club into submission.

April 20 and 21 will become a date infamy as NARGASM '74 (National Association of Rocketry Gateway Arch Super Meet '74) will be flown "in the vicinity of Festus, Missouri."

The events are Mercury Dual Egg-loft, Gnat B/G, Eagle R/G, Class 00 Parachute Duration, Class 1 Altitude, Peewee Payload, and Swift B/G.

All seriousness aside, folks, NARGASM '74 should be a relatively good meet (but then, compared to JEFFCAM, anything could be considered good). The events range from the bland-but-easy to the exciting.

Most likely the site will be the chat-flats in Bonne Terre, unless a suitable field can be found in the Festus-Crytal City area.

All local clubs are invited and interested persons should contact: Rob Cayse, 501 Rose Lane, Festus, Missouri, 63028.

LARK - 2

The ARK-LA-TEX Model Rocketry club of Bossier City, Louisiana, has informed us that they will be sponsoring the second Louisiana Rocketry Contest (LARK).

The meet, scheduled for April 27 and 28, will be held in Bossier City

and the expected section attendance includes the Dallas Area Rocketry Society and Apollo/NASA.

The events are Class 1 Streamer Duration, Class 0 Parachute Duration, Peewee Payload, Sparrow Rocket Glider, Robin-Egglofting, Hornet Boost Glider, and Class 3 Scale Altitude.

Awards include trophies for division winners and possibly for first place in each event in three divisions and ribbons for second thru fourth place in each event in three divisions. Kits are also to be awarded.

Fees are \$1.00 per event with a \$5.00 maximum. A \$1.00 fine will be levied on entries returned after April 15, 1974.

Interested persons should contact: Mark Knox, Jr., 1117 James Street, Bossier City, Louisiana, 71010. Y'all come, hear?

WORM - 2

Everyone remembers the great coverage of WORM 1 in the *Model Rocketeer*. Now, from the people who brought you WORM 1 comes..... WORM 2!!!!

WORM 2 will be sponsored by the Omega Model Rocket Society of Oconomowoc, Wisconsin. The date of the meet is May 4 and 5, and (obviously) the site will be in Oconomowoc.

The events include Class 00 Parachute Duration, Class 0 Streamer Duration, Gnat B/G, Gnat R/G, Hornet B/G, Hawk R/G, Scale, and an event called "Super Roc Parachute Duration."

(Continued on page 26)

HERE'S AN ALTITUDE DESIGN THAT WE FORGOT TO PUT IN THE LAST
BLUEPRINT SPECIAL

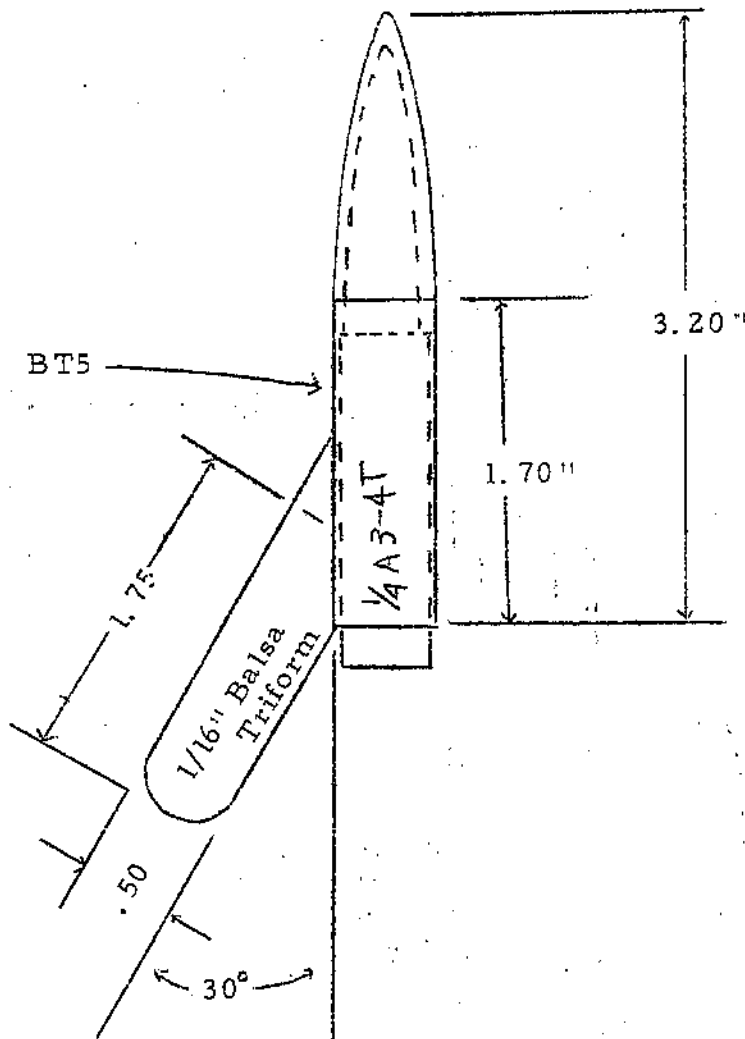

Streamer Recovery
Rear Ejection
12" of #20 line as shock cord
Piston Tower Launched

Design Efficiency
11-8-72
J. Robbins

PISTON TOWER

J. ROBBINS

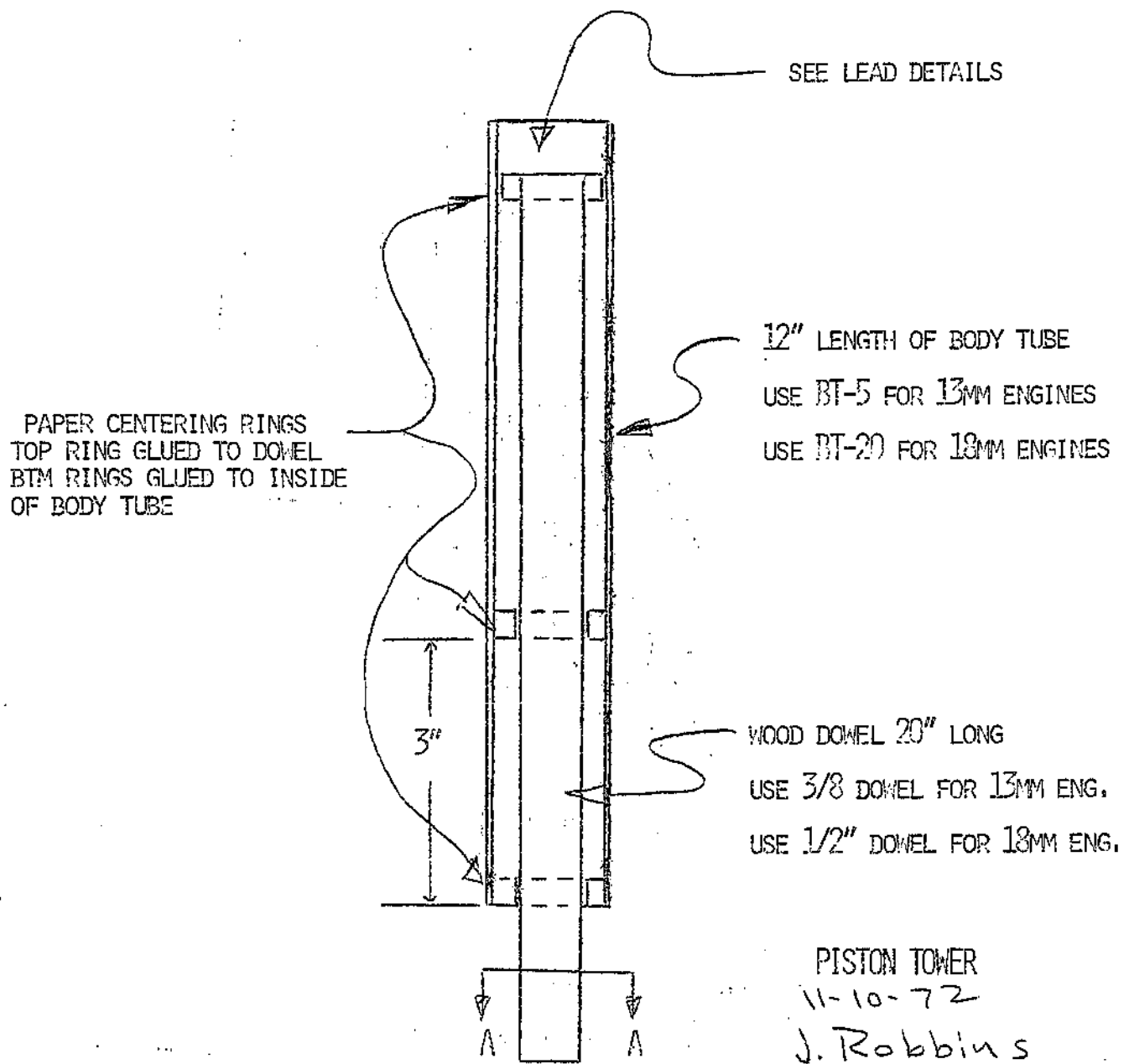

RUN IGNITION WIRES DOWN
2 SLOTS CUT IN DOWEL, EPOXY
TO HOLD IN PLACE

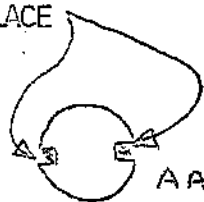

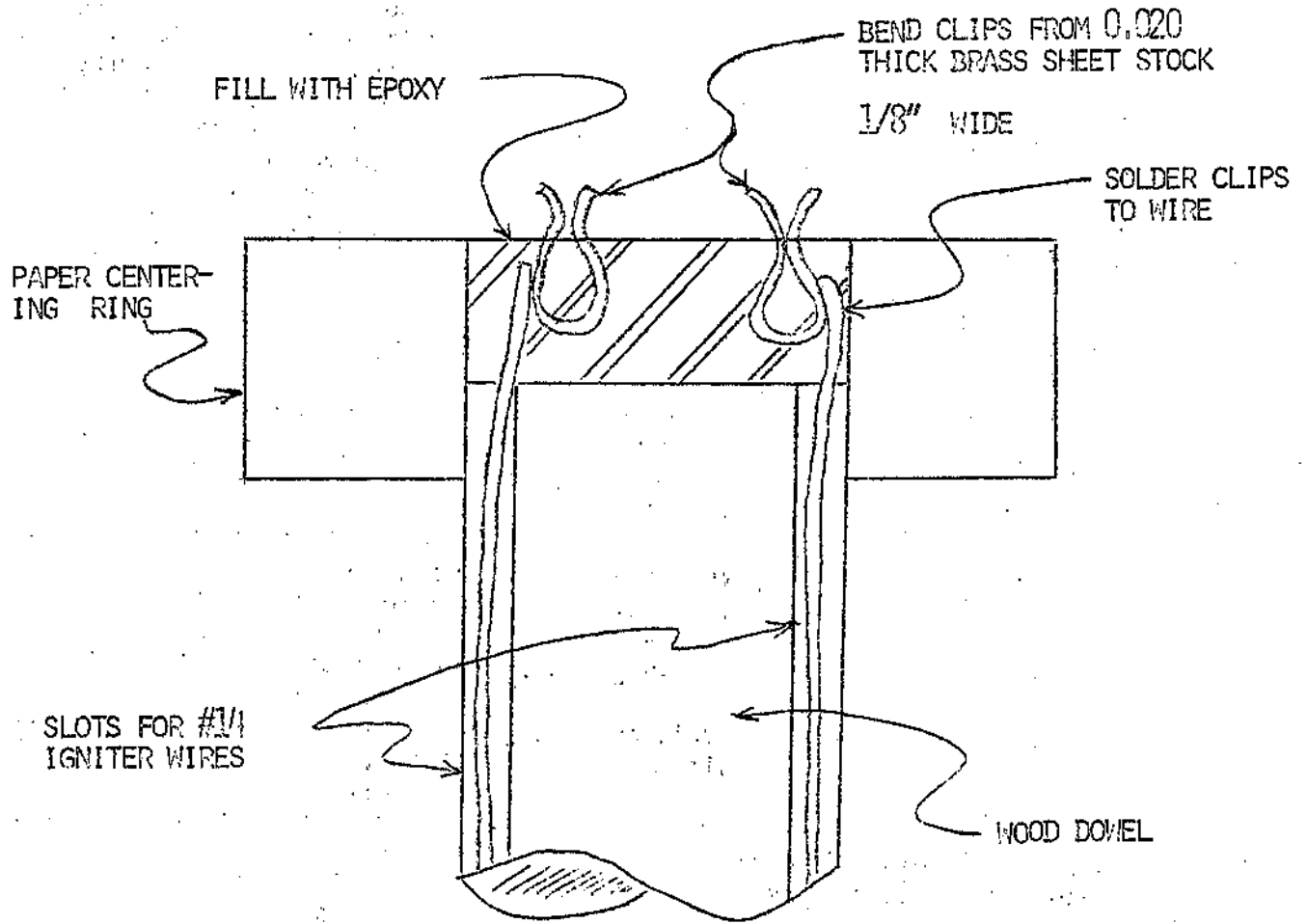

PISTON TOWER IGNITOR LEAD DETAILS

11-10-72
J. Robbins

TRIMMING - TO GLIDE OR NOT TO GLIDE, THAT IS THE QUESTION

BY RANDY PICOLET

There are two big currents of thought regarding trimming in the spectrum of boost/gliders today. First, there are the Good Guys, who take their methods of trimming from the more experienced model airplaner. The method used by these people is basically an all-out heave-ho. I will cover this in more detail later.

The second method, used only by the Bad Guys, (and sometimes by Good Guys who are having a moment of hysteria) consists of a toss from the shoulder. It has what I call the Ballistic Blahs, some of which I will now describe:

- A) It's crappy.
- B) It becomes airborne at an air-speed and an angle of attack which are entirely determined by a comparatively intelligent being. Thus, it is being trimmed in unrealistic conditions, conditions which are probably never found in real flight.
- C) If there is any wind (when isn't there?), the relatively short flight can be deceiving about how the model really glides.
- D) It's crappy.
- E) Don Carlson uses this method. (And that should convince anybody.)

If you are a Bad Guy and you actually duplicate flight conditions with shoulder toss, then you're either a Goliath-and-a-half or there are pressure gauges growing out of your arms. However, the shoulder-toss method does have some uses. For instance, if you build a glider that takes two hands just to pick it up, then you can't very well toss it 25 feet in the air. Also, it serves as a starting point for the Good Guy method (which, like the commercial says, finishes the job the Bad

Guy method only starts.) I will now go into the Good Guy method in more detail.

Surprisingly, I am a Good Guy. I will relate one of my past experiences with trimming, so that all can benefit from my invaluable experience.

First, I picked up my freshly completed Hornet and Hawk B/G's. On my way out the door, I stole my mother's masking tape and grabbed some clay from my Ronco Super-Duper \$9.95 "Some Clay" Dispenser (about 4.037 ounces worth). Upon stepping out of the door, I found myself in my back yard. You can use your back yard only if it is 20 clear acres like mine. Minimum size is about a football field. I walked to about 50 feet from the upwind edge of the field, and, after a brief moment of hysteria, proceeded to shoulder toss the Hornet. After it seemed to establish a trend of almost stalling and turning to the left, I was ready to give it its first good throw. Standing so the wind was coming from my right (I'm right-handed), I held the Hornet with its left wing almost straight up in the air and tossed it with about half my feeble strength at a point 10 to 20 degrees above the horizon. It went into a spiraling climb to the right and climbed to about 20 feet, stalled big twice, and hit the ground. This is the way all of my gliders start, because it's disturbing to my peace of mind to see a brand new glider dive from 30 feet the first time I throw it.

From then on, I added and subtracted trimming weight where needed until the glider seemed to be gliding as slow as possible without stalling to any great extent. Since it was cold, I had to use the masking tape to hold the clay onto the glider. That's really all there is to it, but here are a few tips:

- 1) If you're timing more than one

glider at a time, start with the lightest. Otherwise, you'll throw the light ones into the ground and ruin your arm at the same time.

2) Add and subtract weight in small amounts, so you can predict the next flight on the basis of the last one.

3) If you add weight to the nose, you will have to remove some trim weight from the wing tip, and vice-versa, to maintain the same degree of turn. Likewise, if you are changing the radius of the turn, you will also have to adjust the trimming weight on the nose. This is important, and the reason for it is well explained by Bob Parks in the January '71 issue of *Model Rocketry*. If you can get hold of a copy, it gives the best explanation I've seen without getting into any math.

4) Always throw the model so it turns into the wind. The reason for this is to prevent collision with Mother Earth. One or two things will happen if you do: A) it will loop over your head and right back down, and B) it will turn as supposed to, and the wind will catch its underside and force it sideways into the ground.

5) A word about directions. You may think I'm nuts telling you to add trim weight to the left and then throw it with a right turn, but there is a reason. As you release the glider, the "bank" caused by your holding the left wing up will turn the glider into the wind. Just about this time the glider is facing directly into the wind, the heavier left wing will have leveled out the glider. It will then be at an altitude of twenty to thirty feet, and, without any help from you, will demonstrate its actual glide. It's high enough to show any stalls that might develop. If you're left handed, reverse all directions.

Do not throw the glider backwards!

6) Occasionally you will encounter a nose-heavy model that needs trim-weight on the tail. Simply make sure it is flying as required (almost stalling and to the left) before throwing it with any power.

7) Note that these directions are not absolute. For a given day and glider, you may turn a little with or against the wind, and you can change the angle and speed by a large degree over the starting point. The very best thing you can do is get in a couple of hours of practice on a sturdy glider, and experiment with the various factors.

8) As far as the actual flight desired, this depends on weather conditions. Ideally, in no or low wind, a flat, slow circle is best. Should you ever get these conditions, the glider will still trim the same way, but you don't have to worry about where the wind is coming from. However, this is very rare, so we have to come up with a compromise. The best glide for wind is a reasonably tight turn with the glider slightly stalling into the wind and not quite diving when its tail is to the wind. This is probably the biggest advantage of this method in that it will show all the phases of the glide.

9) You should re-trim each glider just a minute or so before you put it in the pad for a flight, so that the wind and thermal conditions are the same after boost as they were when you trimmed the glider. Don't wait until just before you launch to start trimming a bird for the first time. You should thoroughly know all the little quirks before-hand, and have an exact solution for the problems.

I can usually get a glider to stay up for seven to fifteen seconds while trimming, (I lost one Hornet in a thermal (Continued on page 27)

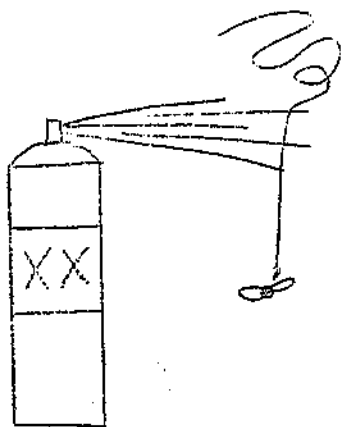

RAID

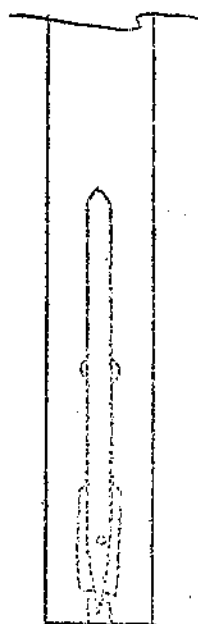
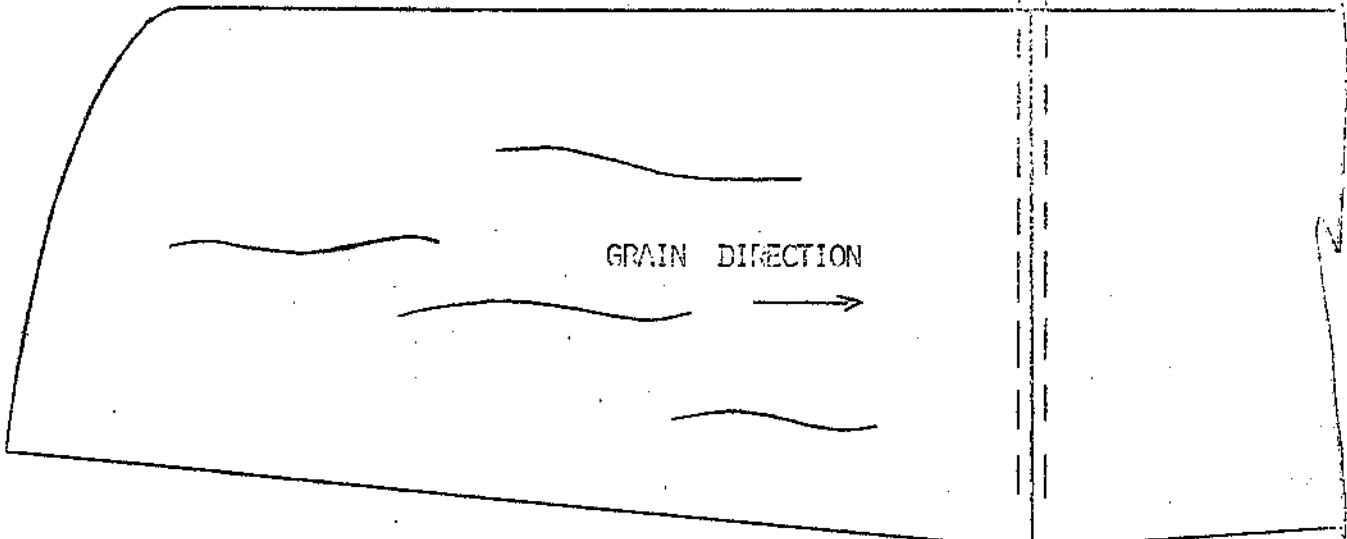
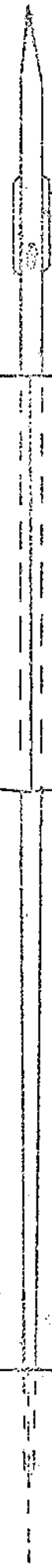

1/32 Balsa - C GRAIN
TISSUE COVERED

ALL DRAWINGS
FULL SCALE

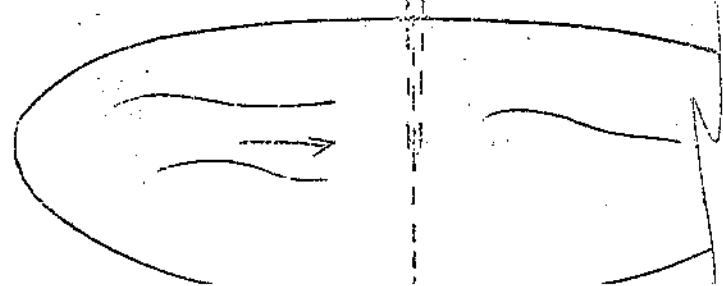

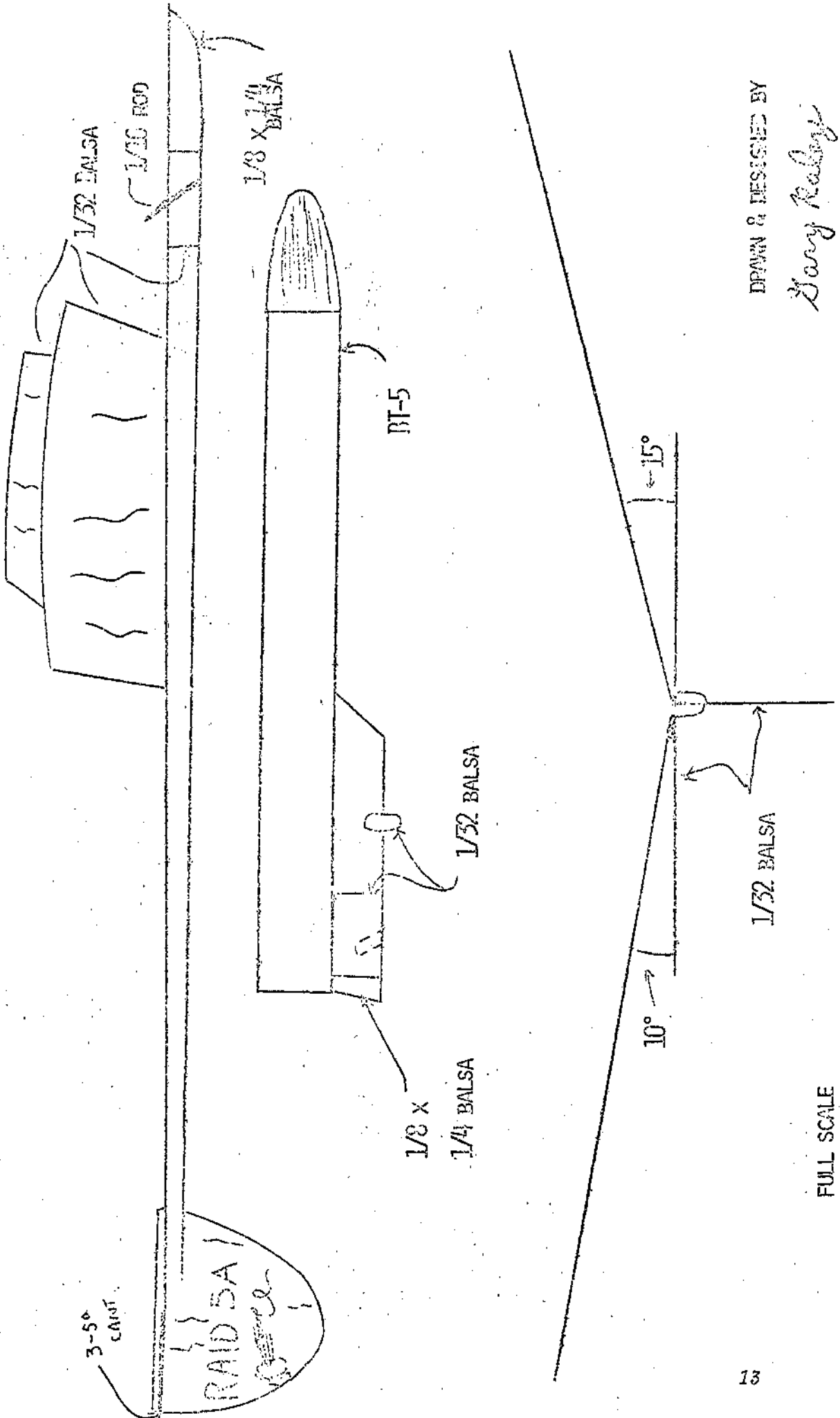

DRAWN & DESIGNED BY

Darry Roberts

FULL SCALE

2001 SPACE CLIPPER

By Don Carlson

(This article is merely my modifications to Bob Parks' Aurora Space Clipper conversion plans that appeared in the January, 1972 issue of Model Rocketry. I suggest that you refer to his article if this issue is available to you. All credit for this article is Bob Parks'. The drawing was traced from a drawing by Harold Youngren.)

With this kit, some body tube, and clear plastic, you will be able to construct an impressive and functional model rocket that will amaze your friends and be a threat to the other entries in Plastic Model Competition.

As I said before, the conversion plans come directly out of Model Rocketry magazine and since I am the only person in the club who has that particular issue, I could be anti-social and not let anyone see it, or maybe even rent the copy (at a nominal fee, of course) to interested parties. Instead, I have seen fit to pass on this information. (The way I see it, if you're crazy enough to convert this bird, you deserve the plans.)

To begin with, get your hands on an Aurora Space Clipper kit and after tearing hell out of the wrapper, separate the plastic parts from their trees. (CAREFULLY! Do not twist off the plastic or you will have gashes in the good parts and extra plastic on the garbage.) Then with an emery board or fine sandpaper, clean off the excess plastic from the seams and joints. DO NOT try to clean away flash from seams with a sharp X-Acto! Nine times out of ten, you'll flinch and cut a nice, fat gouge into your model.

Use an X-Acto for small areas, such as the windows. Trim off those little rods protruding from the rear of the exhaust nacelle. They'll only be in the way and will probably become charred from the exhaust gases.

Cut the fuselage halves at the location directly behind the roughed-up part in the nose (see drawing). Use the molded lines as a guide, and cut carefully. Glue the nose section together using plastic cement. To get rid of as much of the seam as possible, run a line of liquid plastic cement down the seam, press hard equally along the entire section, then wrap the cone with a couple of rubber bands and set aside to dry at least an hour (fool around with it before an hour and you're likely to have to reglue it). When the hour has passed, you'll probably notice that the seam is still fairly visible. Well, kiddies, get out your liquid plastic cement again and paint a very fine line over the seam. (Don't be sloppy about it, Virginia; you'll scar the plastic.) Without touching the glue, squeeze the seams again. This welds the plastic together along the seams and gives you a good bond. For those of you that don't want to hold the idiot thing for an hour or two (the period in which the glue dries), wrap the cone in wax paper (keep the pressure on while you wrap) and then put rubber bands around the wax paper.

It will be necessary to eliminate the engine room bulkhead or else cut a hole in it to clear the recovery system tube. I chose to eliminate it since it really doesn't show that much and it is a heck of a lot easier to leave it out. Tape the rear sections of the halves together and tape the tail cove halves together. Glue the right tail cove half to the right fuselage and the left tail cove half to the left fuselage. Be careful to obtain the proper alignment since their aren't any alignment pins. Don't glue any of the right side parts to the left side parts. Let the glue dry. I messed around with mine too soon and had to reglue them. After they are dry, remove the tape as separate the halves. The goal of this pro-

cedure is to obtain two full body halves. (If you are insistent on an engine room bulkhead, trim out the bulkhead, leaving only a ring. Tape the parts together as before. Glue the ring to the right side parts only. The left side is to be used for alignment.)

Cut two BT-20 tubes, one 6" and the other 2.5". (If you don't have a CMR body tube cutter, I strongly advise you to get one. It is inexpensive and greatly simplifies the task of cutting tubes.)

Cut another tube to 1/2". Glue a nose block (NB-20) into the piece of BT-20 so about 3/8 of the nose block protrudes. About .5 ounces of clay should be stuffed into the inside of the nose at this time.

(Interesting things happen when you walk into a hobby shop and ask for an NB-20. "NB-20. Is that a Centuri part? We don't carry Centuri parts." "No, its Estes." "NB-20? Let me look." He then proceeds to open drawers and boxes, dumbfoundedly searching for the elusive piece of balsa. "Here you

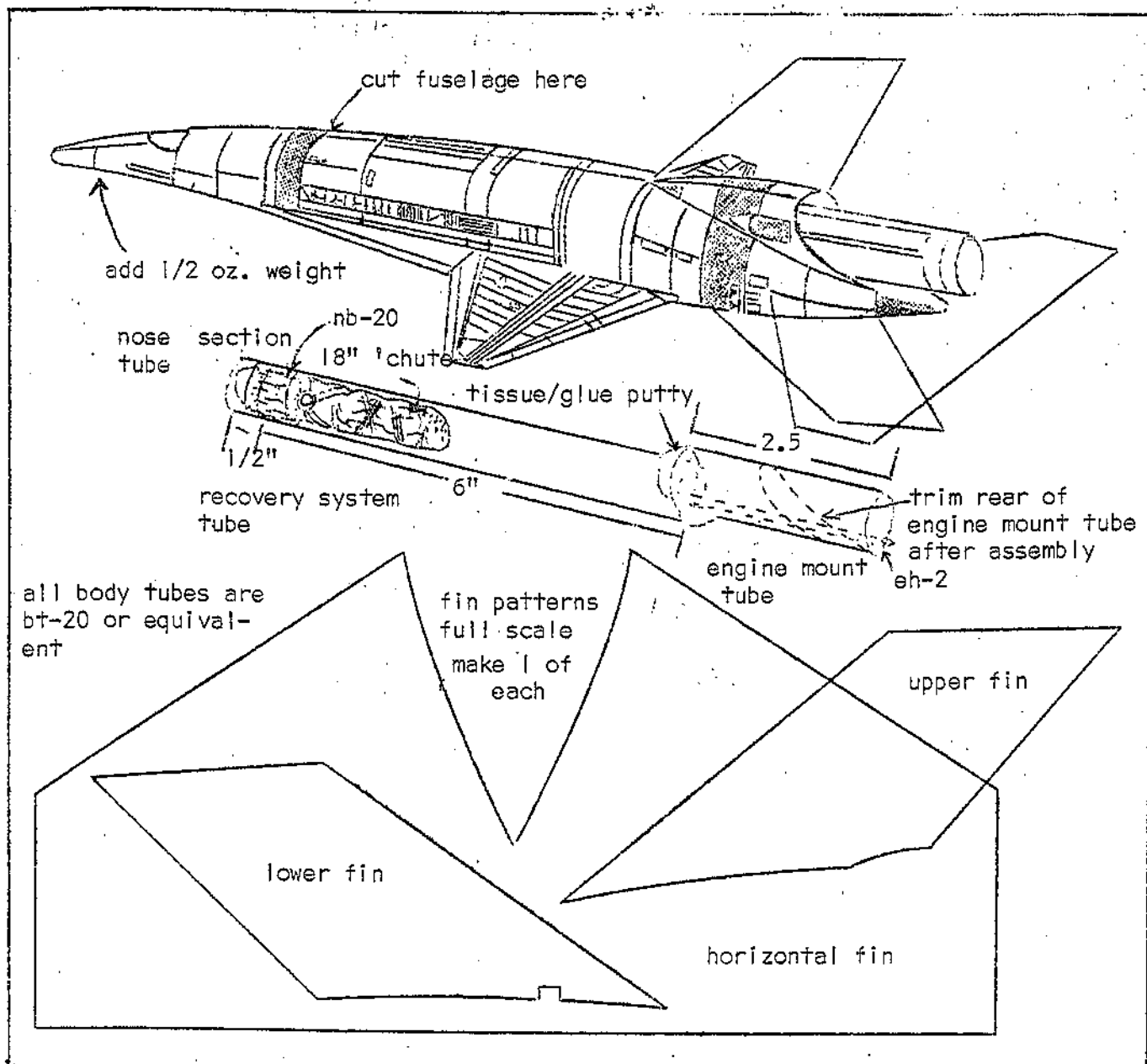

go. NB-20!" He has just laid an assortment of BT-20 nose cones on the counter. "These are nose cones. I want a nose block." "NB-20? Noseblocks? [If he's crafty, he acts like he knows what they are but more often than not, he doesn't] "What's a nose block?" "It goes on the end of a BT-20. It's used on payload sections." He looks once again, perhaps waits on another customer, then usually says, "We don't have any NB-20, but I'm expecting a big shipment in from Estes.....)

If you cannot find an NB-20, use a small BNC-20 nose cone that you think will fit close enough so that it will require only minor modification. Of course, with a nose cone, you disregard the instructions about the 1/2" tube and all that.

1/2 ounce of clay in the nose is a bare minimum. I advise upward to 1-1 1/2 ounce. This is strictly up to you. If you are fast and think that you can out run an unstable Space Clipper, use 1/2 ounce. If however, you are fat, like I am, and make a pretty good target, use about 1 ounce.

For those fortunate few who find NB-20's, the plans continue: Tape the nose cone to the right fuselage side. Insert the nose block into the front of the recovery system tube. The BT-20 is placed inside the same section so the body tube joint is even with the rear of the nose section. Most of the trouble you just went through was to align the recovery system tube with the nose. Let everything dry completely.

Time to install the engine mount! It will be necessary to notch the front of the engine mount tube so that it can overlap the recovery system tube. The best way to find the proper location for the notches is by test fitting the tubes. The notched should be about 1/8" long. Mount an engine clip (EH-2) on the bottom of the engine mount tube. The front of the clip should be about 1/8" back from the end of the notched. Glue the tube

in place, using fast drying epoxy for paper to plastic joints. Make certain that the tube is parallel to the bottom of the fuselage. Use the seam as an alignment guide.

Fill the front of the engine mount tube and the back of the recovery tube with at least 1/8" thickness of tissue paper soaked with white glue. Check the drawing with your model. They should begin to look alike. Set this assembly aside to dry.

After allowing the white tissue/putty to dry, glue the left fuselage half in place, using plastic cement. Use the same procedure as before to get rid of the seams. All of the remaining white parts are glued on at this time. (Don't put the windscreen and cabin windows in yet!)

You are now ready to paint the model. I used a can of Pactra Flat White on the body (spray on fine, coats and don't try to spray it all at once; use several coats). Details were painted with a fine grade brush (000) using flat black and flat aluminum. (You'll probably not find flat aluminum, so silver is okay. For a really impressive model, use a Rapidograph pen and India ink and trace in all the panel separation lines. (I couldn't find the pen or the ink, so I used the fountain pen part on a cheap compass and some of my dad's blue-black ink. If you want to purchase a Rapidograph, try an office supply or a store that supplied drafting equipment. Be sure not to touch the lines after you trace them and never, never, never, let any water come in contact with the lines; they'll run all over your model. Use a can of clear or clear flat spray paint to waterproof your model."

The windscreen and cabin windows can be inserted at this time. I suggest you paint the back sides of the windows black.

If you've got some Estes clear fin stock, congratulations!! Otherwise, you've got to find some clear plastic (Continued on page 27)

THE VULTURE VIII

BY STEVE BEHREND

You and I both know that there is only one of two reasons why you are reading this article; either you are having trouble with your present R/G design (low performance, no reliability) or you wanted to see just how much of a fool I would make of myself by feeling competent enough to write this article. For purposes of ego-building, I shall deal only with the first reason.

Having spent (wasted) several dollars worth of balsa on *Groundhogs, Julie Birds, Flickers, Sarges*, etc., I believe I could say that I am familiar with most types of R/G *genre*. After some thought, I decided that the engine shift (c/g) was what I was looking for.

Using this system, a rocket glider would be a reliable (e.g. have few moving parts), would boost well (no looping - a real problem with no-moving-parts R/G's), transition quickly, glide efficiently, and be fairly light. The main disadvantage to this system is that there is no reduction in boost-phase drag, but I believe the increase in reliability and consistent performance outweighs this.

The design I developed was entered in Hornet R/G at five contests and placed first at four of them. As a matter of fact, I took first at one contest even though my pod failed to shift back!

My best time in Hornet was 50 seconds (with no thermal). A well built *Vulture* will turn in consistent 45 second times.

CONSTRUCTION

Since this article was written for those who have built gliders before, I will only describe the things that separate this R/G from others.

I personally finish the wing, tail

boom, and pylon with one coat of clear dope, sanding after. I then add magic marker for visibility and eye appeal.

Sand the spirals off the CMR RB50 and RB52 tubes.

Then completely construct the glider except leave off the nose cone and rubber band. If you have constructed the model correctly, the RB52 tube should slide easily through the RB50, but the end stops should keep it from sliding all the way out.

Then cut a "V" shaped furrow through the entire length of your nose cone, shoulder and all. This will serve as an exhaust port. You are probably wondering why I put the exhaust port in the nose cone instead of the sides of the RB50. This is because after a while, the sides of the port begin to crumble, and crud from the ejection charge forms around the port, thus not allowing the pod to slide freely. Sanding this off only weakens the area further. Besides, a tube with side ports is too easily bent by a taut rubber band.

Insert a two inch rubber band (1/4" wide) into the forward end of the RB50. Add glue to the nose cone shoulder and insert it into the same end of the RB50. The end of the rubber band should now be permanently placed between the RB50 and the nose cone shoulder.

FLYING

Place an engine in the pod. Then pull the pod all the way forward. Take a needle and draw some thin sewing thread through the forward end of the RB52. Pull the thread all the way through from one side to the other. Take both ends of the thread and tie a knot. If you did this correctly, the RB50 should not be able to slide.

(Continued on page 26)

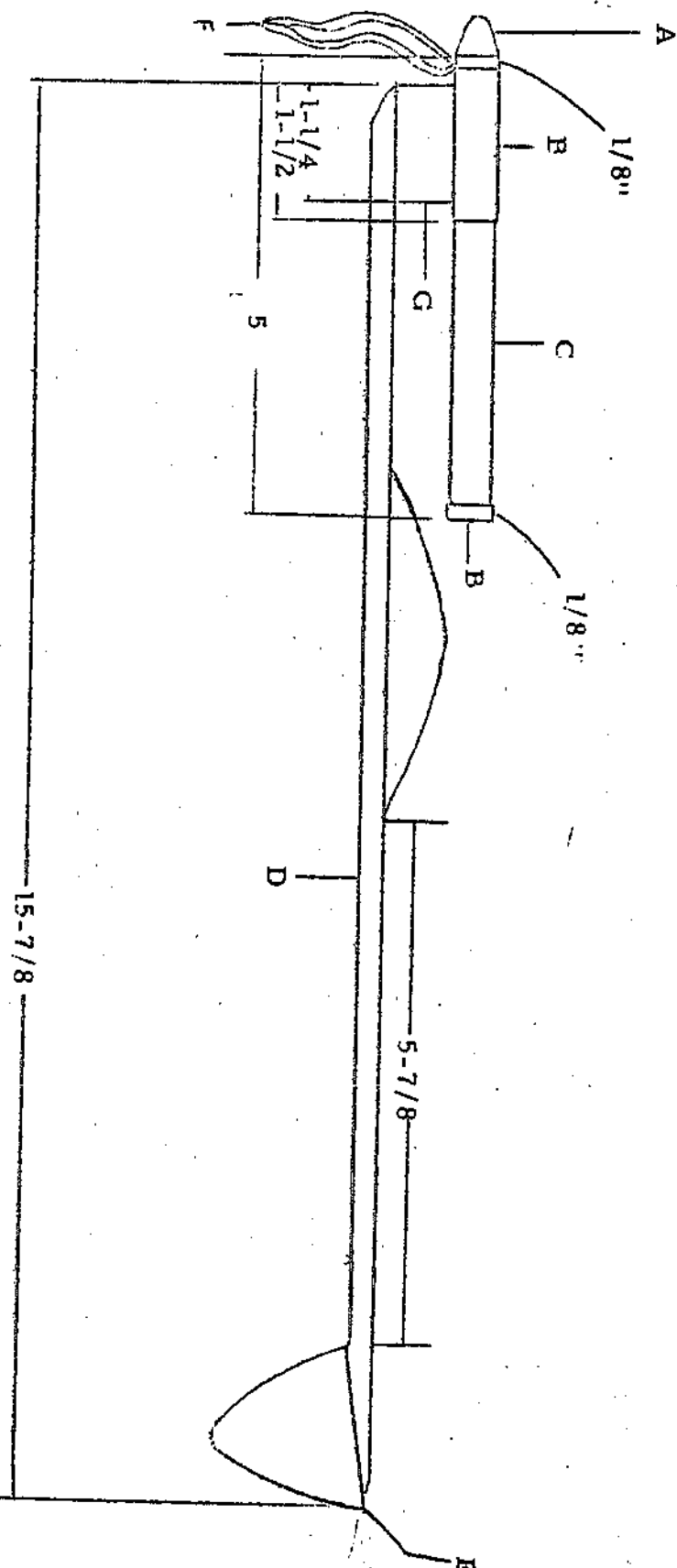

KEY	
A - 6NC-5V	D - 3/16" X 1/2" SPRUCE
B - RB-52	E - 1/16" DECALAGE
C - RB-50	F - RUBBER BAND
	G - 1/2" X 1/8" SPRUCE

SIDE VIEW SCALE - 1:2

IMPULSE
MAGAZINE

VULTURE
VII

DESIGNED BY - S. BEHREND'S
DRAWN BY - D. CARLSON

Cut "V" in cone (see front view)

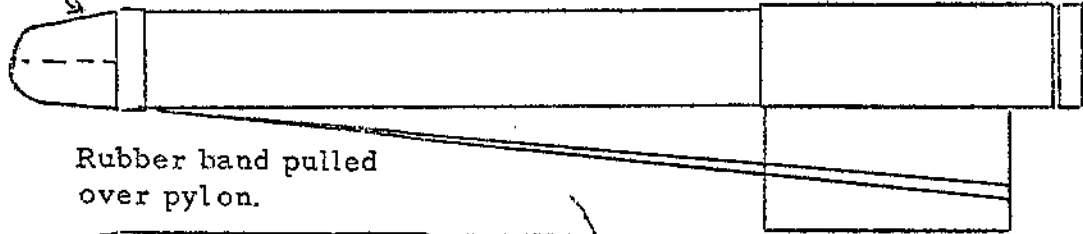

Rubber band pulled over pylon.

BOOST PHASE

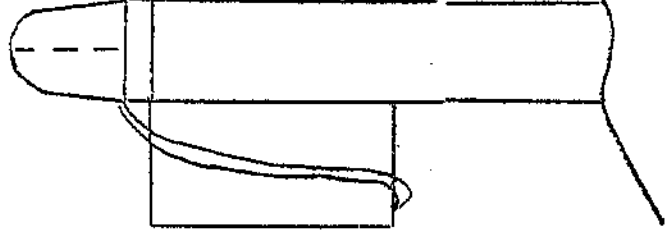

GLIDE PHASE

POD DETAIL - FULL SCALE

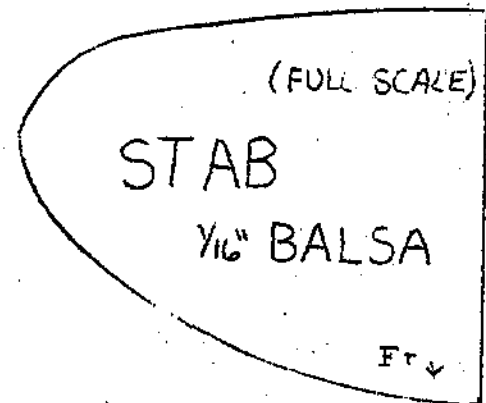
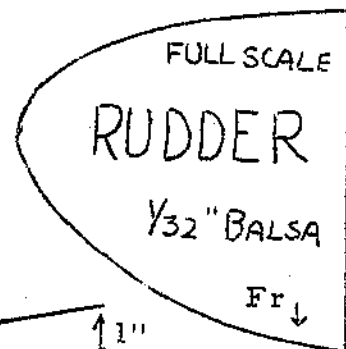

Front View

Front ↑

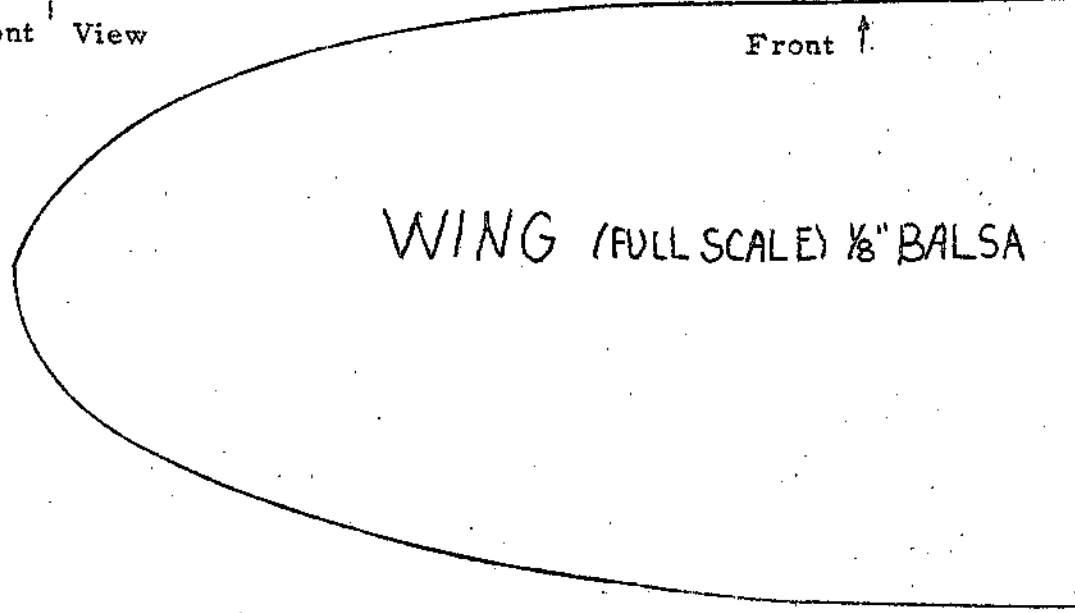

IMPULSE
MAGAZINE

VULTURE

DESIGNED BY - S. BEHREND'S
DRAWN BY - D. CARLSON

BUILDING A WINNING BOOST/GLIDER

BY RANDY PICOLET

Designing a boost/glider your first time out can be a real challenge, especially if you try to follow some set pattern. So here are some rules to follow that should really mess you up. This discussion will be limited to front-engine pop-pod Renger type B/G's.

The easiest place to begin designing is at the wing. Depending on the engine to be used, the aspect ratio should vary between 3.5 and 6. For you aspiring aeronautical engineers out there, the aspect ratio is simply the total span from one wingtip to the other divided by the average chord. Choosing the proper aspect ratio for a particular engine is easy; just use the largest ratio that will stand up to the power of the engine, taking into consideration the material used for the wing. The possibilities are numerous, so I cannot be more specific. As far as the shape of the wing, an ellipse is the best, and an unnoticeable difference behind is a trapezoid that approximates an ellipse. Don't sweep back the wing, but leave it perpendicular to the fuselage.

Once the wing size and shape has been determined, the stab is a matter of taste. I prefer to mock the shape of the wing in the stab, which results in a nice looking glider, but it makes little difference. The size of the stab should be about 1/6 to 1/8 of the size of the wing and generally 2 to 3 times wider than its own chord. The rudder should be about 1/10 of the wing area, and placed as far back as possible without extending the fuselage. The distance from the rear edge of the wing to the front of the stab should be about one wing chord for low-aspect wings, and about two chords for a 6-aspect ratio.

The fuselage should extend at least as far in front of the wing as it does behind. I've found that most gliders are tail heavy anyway, and using a longer nose means less trimweight would have to be used. Besides, it can be hacked off if it is too long. (Did you hear the one about the B/G that got hacked off when it couldn't glide?) Short noses on gliders seem to be modeled after airplanes which have heavy engines as passengers in front, but there is no such weight (until added in the form of trim clay) on gliders.

The pod on a glider is nothing difficult, but it is sometimes helpful to use a long pod to help prevent arcing, especially with larger engines. The standoff should be as small as possible so as to prevent too much torque from off-center thrust and still not burn the heck out of the glider. About 5/8" should be between the nozzle of a mini-engine and the fuselage, and 3/4" to 1" for the larger engines.

The materials used for gliders are many. Wings can be made from balsa, styrofoam, and such, but I have worked only with balsa. The thickness of the wing depends on the design and the engine. As thin as 1/32" balsa can be used for a 1/2A if it is covered with Jap tissue *a la Raley*, and 1/8" tissue covered balsa for a C. If not tissue covered, the 1/16" and 1/4" would be best for these situations. In general, a large aspect ratio requires a thicker or strengthened wing, and vice versa for a low aspect ratio. Anything using more than a C is your own guess.

The stab and rudder can usually be made from balsa half as thick as the wing, with a minimum of 1/32". The ideal material for the fuselage is 1/8" spruce for Athru C engines. Either 1/8" balsa

or skinny spruce can be used for 1/2A's.

Once the design is arrived at and the materials obtained, you are ready to build. Here is rule number 14-35A.

Pick a point directly behind where the wing will be located on the fuselage. Anything in front of this point should be glued using epoxy (including the pod), and anything behind with Elmer's. Cut the wing panels and airfoil them as much as possible. Sand the root edges at an angle and glue them together at a dihedral angle of 10 to 25 degrees, more or less depending on the weight of the glider. A heavier model needs less dihedral than a light model. A polyhedral can be used for high-aspect-ratio wings to provide more strength and stability.

Any edge that is not needed for a mating joint or for strength should be rounded. Put a symmetrical airfoil on the stab and rudder, as though they were fins. When using thin wings that have little airfoil (1/8" or less) be sure to prop up the rear of the stab about 2-4 degrees so that lift will be generated by the wing. This also helps to counter-act any off-center thrust. Use your favorite method to connect the pod to the glider.

If you paint the glider, so it with one light dust coat, and then sand it down.

I have specifically avoided trying to give you specifics on how to design a glider, so that all gliders don't look alike. Despite what it may sound like, there is a lot of freedom in designing a glider. It's just that the better designs need less trimming.

Well, here you have in a few hundred words all the knowledge of flight, which has taken Man many hundreds of years to obtain. If your glider still doesn't work, blame Aristotle, not me. If anybody who reads this thinks they can do better, go ahead Tom.

MOPAC NEWS

by Rob Cayse

Before I get down to the nitty-gritty, I would like to say a few words about the last issue of *Impulse*. The scissor-wing R/G that I launched at St. Louis Area Meet 4 did not shred as was reported in the "Capsule Communications" column; it just made three big loops and then glided like a rock.

At the last meeting, the possibility of a building session was brought up and Keith Vinyard volunteered his basement. However, full plans have yet to make it off the ground.

Our recruiting drive is going fairly well, but we still need many more members. If you know anyone who is a potential member, don't wait until tomorrow, start hounding him today.

If you would like to join the Model Rocketry and Aeromodeler's Club, contact me at 937-4451 or write to 501 Rose Lane, Festus, Missouri, 63028.

NOTICE:

IMPULSE NEEDS TECHNICAL AND SCALE ARTICLES. IF YOU HAVE AN ARTICLE THAT YOU WOULD LIKE PUBLISHED, SEND IT IN!!!! IF YOUR ARTICLE IS PUBLISHED, YOU WILL RECEIVE EITHER - 1) A FREE NAR MEMBERSHIP OR RENEWAL, 2) \$5.00 COLD CASH, OR 3) A \$5.00 GIFT CERTIFICATE.

THIS OFFER ONLY APPLIES TO SCALE AND/OR TECHNICAL ARTICLES.

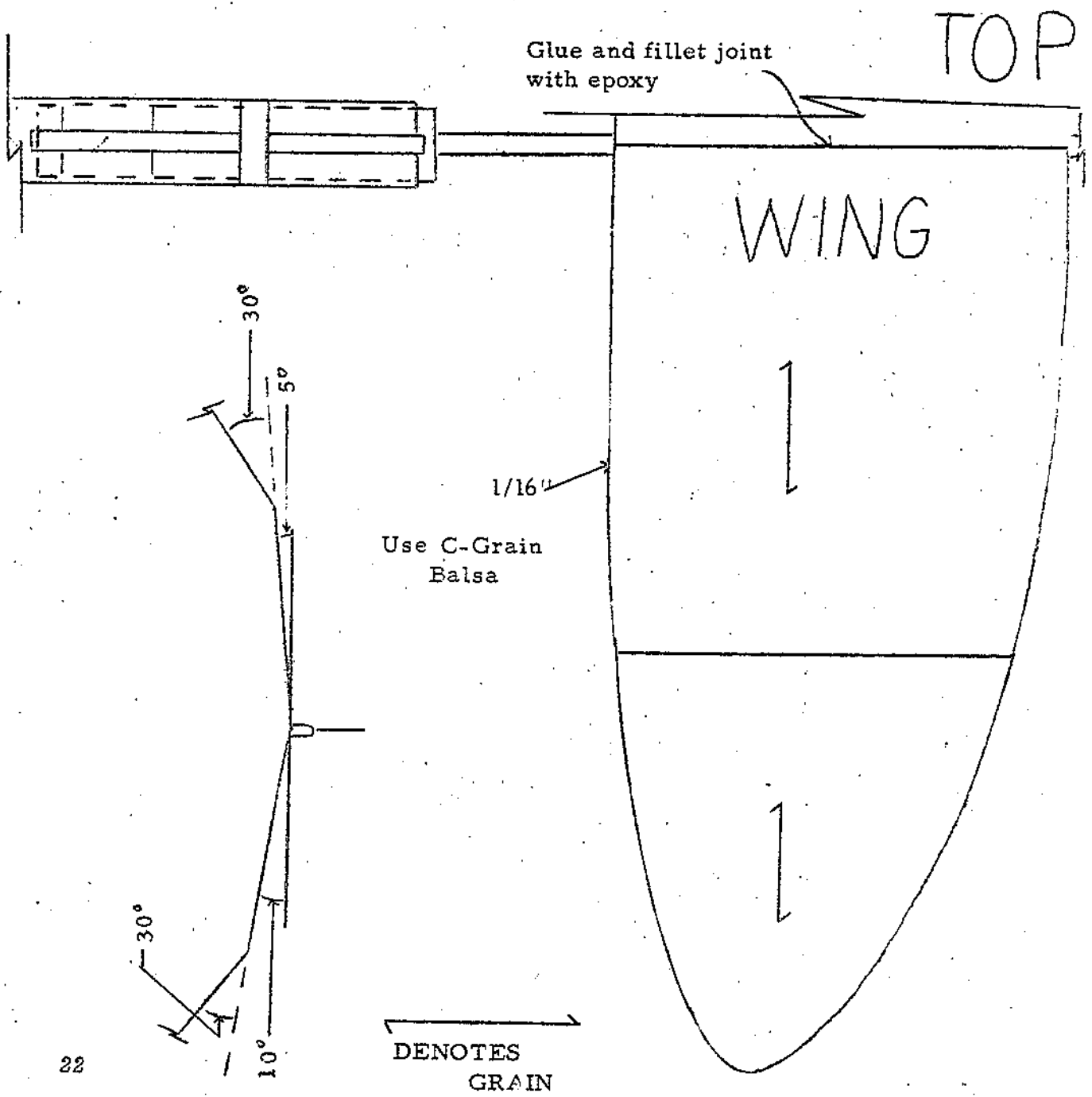
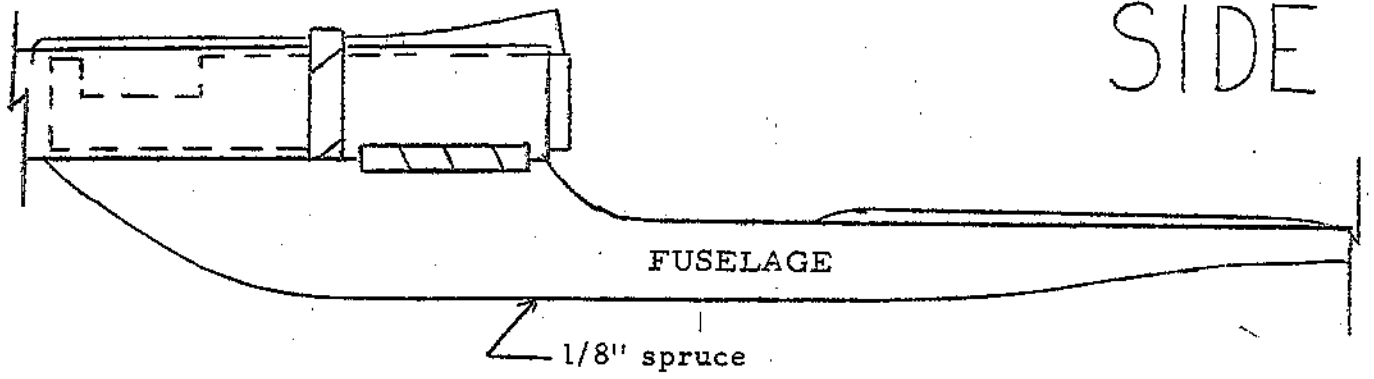

VIEW

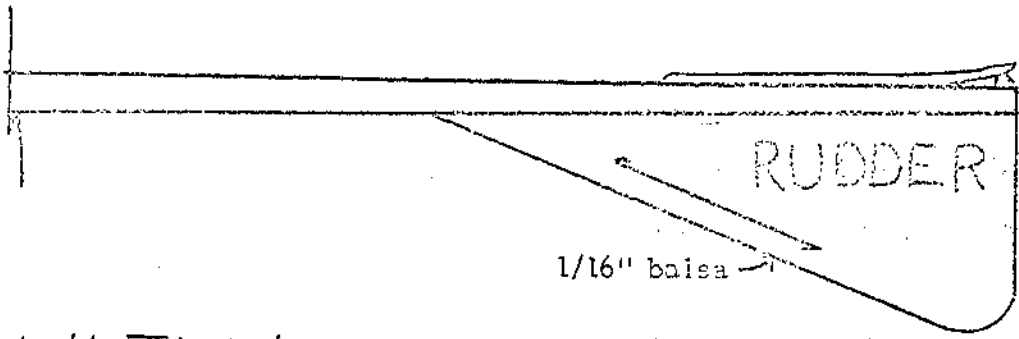

VIEW

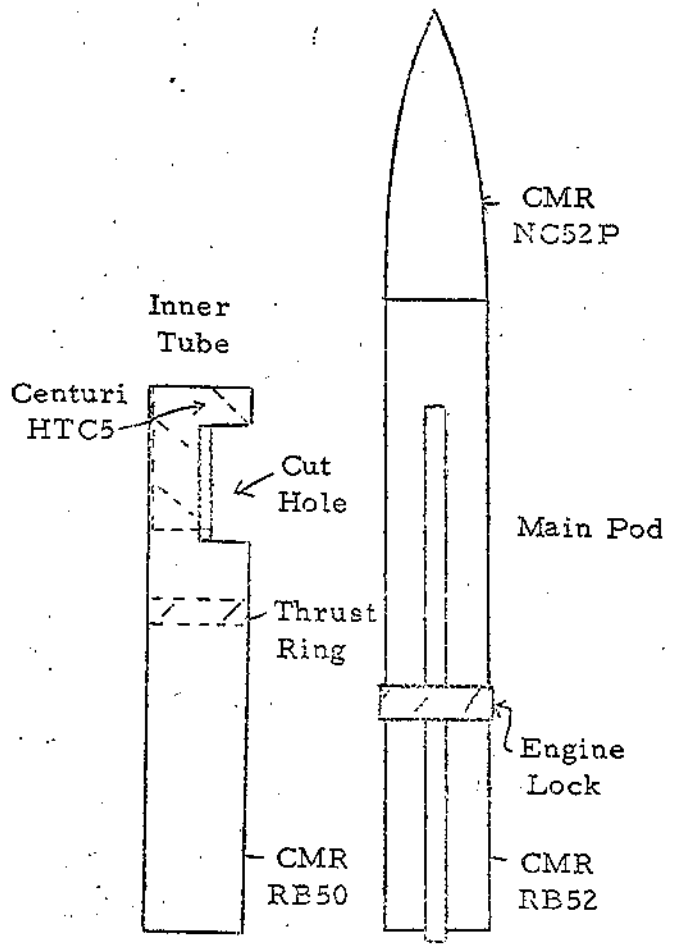
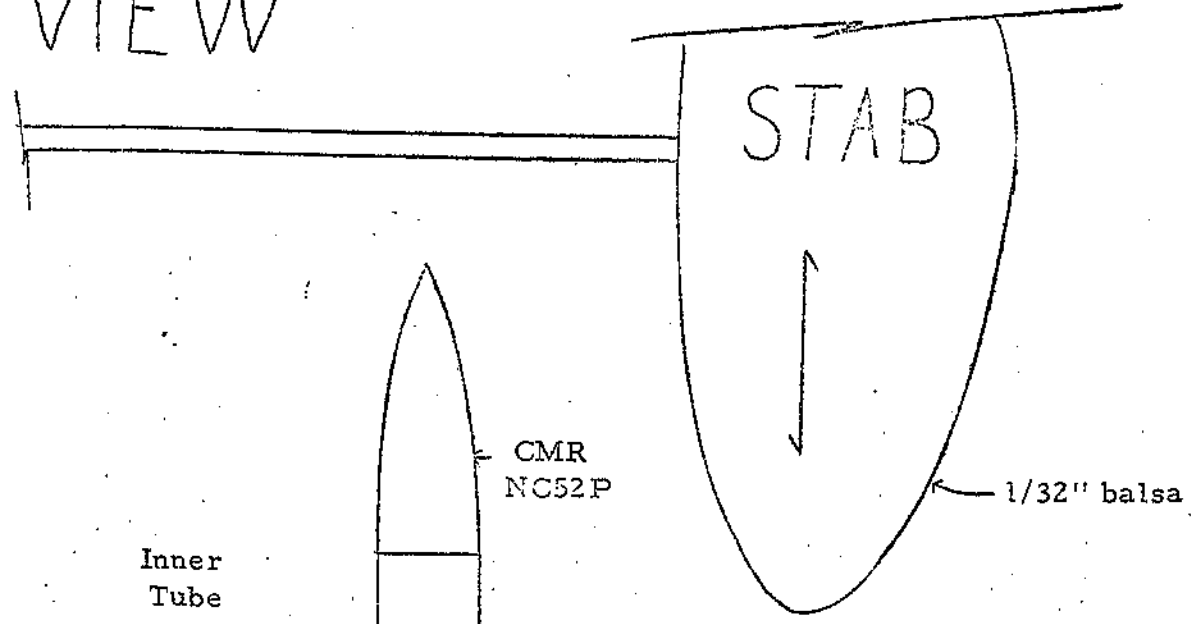

When launching, line up hole with engine lock.

PAGAN V
SPARROW ROCKET/GLIDER
RECOMMENDED ENGINE: A9-3T
DESIGNED and DRAWN by RANDY PICOLET
Featured Reporter for IMPULSE mag.

CAPSULE COMMUNICATIONS

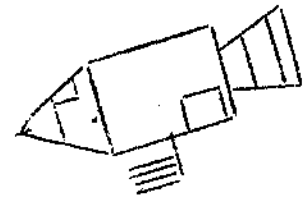

THIS MONTH'S ARTICLE IS NOT CONCERNED WITH MODEL ROCKETRY, BUT WITH AN ARTICLE THAT APPEARED IN A RECENT ISSUE OF THE BIRMINGHAM NEWS. RICHARD O PITNER IS THE AUTHOR. WE HAD TO PASS THIS STORY ON BECAUSE OF ITS TRAGIC HUMOUR. WE FEEL THAT YOU WILL ENJOY IT. THE ARTICLE APPEARED IN THE "PITNER PATTERN" COLUMN AND IS ENTITLED:

FISH ENJOYED BY MAN AND BEAST

"If everyone will be seated in the dining room, I will serve dinner," the pretty hostess said.

She was especially proud of the fancy baked fish dish she had worked long and hard on all afternoon. And now the small talk and cocktails were over, and the three couples she had invited to her home were fixing to sit down to a treat.

"C'mon George, Jim, don't be slow," she urged as she prodded them out of the comfortable living room chairs and pointed the way into the dining room. "You are going to like this. It's the specialty of the house."

When everyone was seated, she returned to the kitchen to get the platter of fish. To her horror, she saw the cat on the kitchen table along with the fish.

She picked up the cat and threw him out the back door, but even then something told her she was too late. Sure enough, a big hunk had been chewed out of the fish and the pretty dish was disarranged.

What could she do? Tell the guests the cat had gotten into the fish and ruined the dinner? Not on

your life. She had worked too hard for that.

She called her husband and whispered instructions: "In a few minutes, I can fix this dish so nobody can tell anything happened. You serve another round of drinks, and I will be there in a couple of minutes. No one will know the difference."

And so the guests dined and bragged on the fish. They told the hostess it was the best they had ever eaten, and it didn't occur to anyone that they had feasted on the cat's leftovers.

About midnight, the guests finally left, and the hostess opened the back door to get a breath of air. As she stepped outside, she jumped and flinched. There at her feet lay the cat, stone dead.

"That cat was perfectly healthy a few hours ago," she told her husband. "What could have happened to him?"

Then she remembered reading a news story a few days earlier which told of one person dying and several others in the hospital from eating tainted fish. She was scared, and her stomach began to feel queasy as she thought of it.

(Continued on page 27)

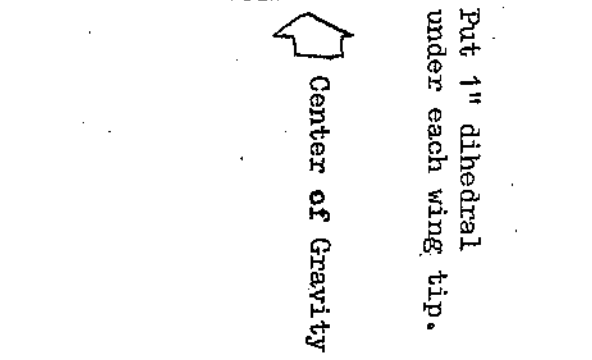
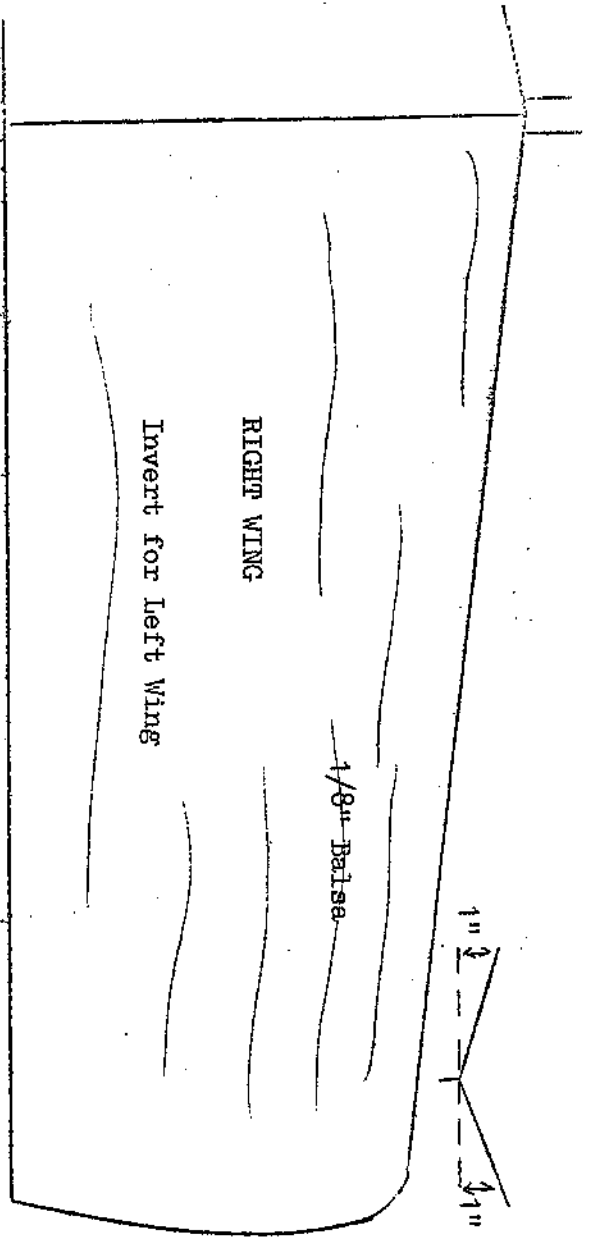

TENDERFOOT B/G	
Wing Span	- 11 7/16"
Length	- 15 1/6"
Designed and Drawn by..... BRAD DIXON	

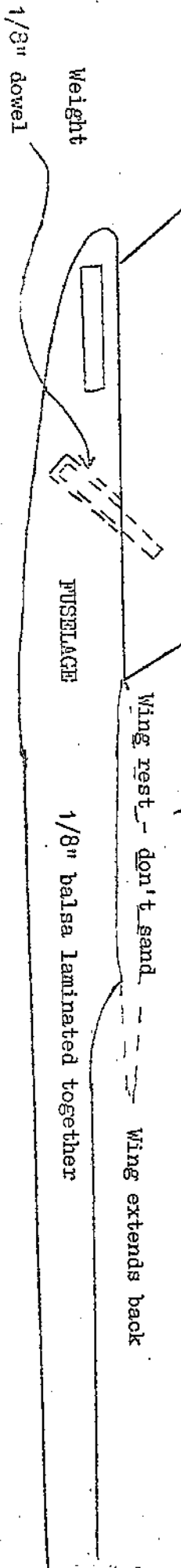
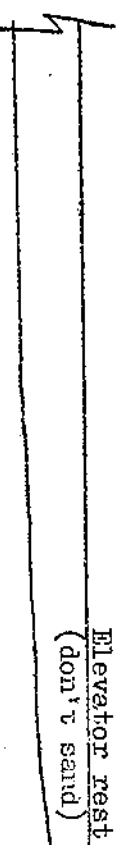
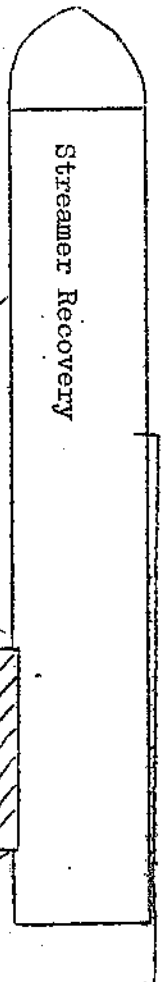
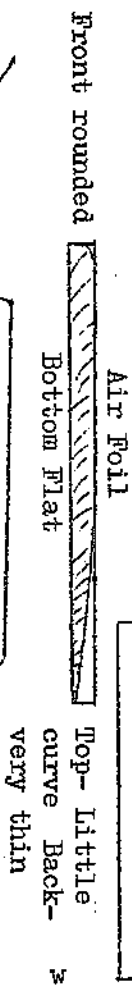
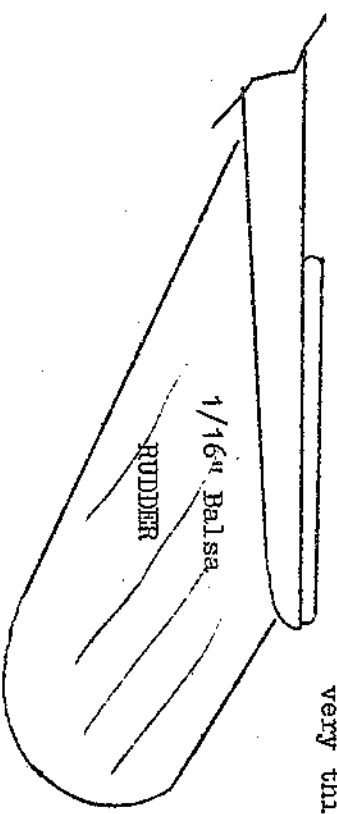
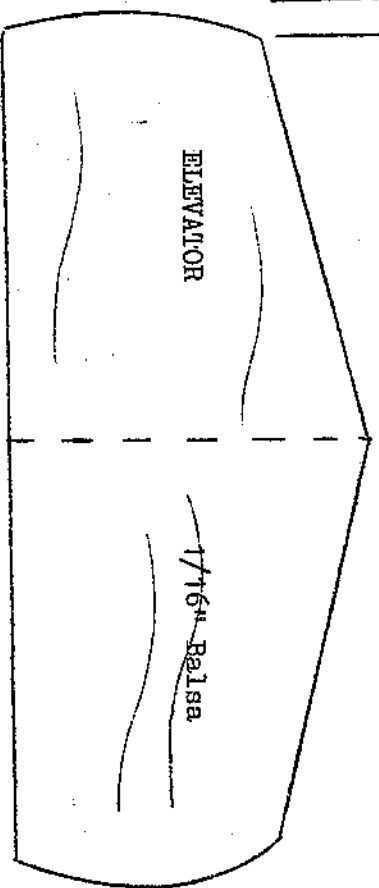

(Contest News, continued)

Super Roc PD is an event set up like standard parachute duration, except that the model must be 24 inches or greater in length, 1.5 inches or greater in diameter, the ejection gasses must pass thru a minimum diameter of 1.5 inches, and power is limited to a 5 newton-second class engine.

The Range Safety Officer has issued a warning that no piston towers will be allowed without a rod to allow for a stable lift-off should the piston tower fail.

Fees for the meet are \$3.00 for C Division, \$2.00 for B Division, and \$1.00 for A Division.

A campsite is within five minutes of the site, and detailed site data will be sent to entrants in March or April.

Interested persons should contact: Tom Gressman, 940 Silvercrest, Apt. 1, Oconomowoc, Wisconsin, 53066.

SCARED - 7

The St. Charles Aerospace Research Engineering will be holding its seventh demonstration launch and display, (SCARED-7) on Goddard Day.

The launch, intermingled with a display, will be held in North Park, next to the McDonnell Douglas Radar Test Facility in St. Charles. A more detailed report on the event will appear in the next issue.

SCATTER - 3

SCARE will hold its next meet, SCATTER 3, on the weekend of May 18. The site will be North Park.

Some of the events echo past SCATTER's while others will be flown

for the first time. The events are Quadrathon, Predicted Altitude, Single Eggloft (class undetermined), Class 3 Altitude, Drag Race, Mercury Duall Eggloft and a boost glider (class undetermined).

Total points available to individuals are 550. Total available points are 1650.

Interested persons should contact: Donald H. Somerville, 612 Maran Drive, St. Charles, Missouri, 63301.

CONTEST DIRECTORS: Be sure to send in your contest announcement to *Impulse*. Please send at least two weeks prior to the meet deadline. Mail announcements to: IMPULSE, Route 1 Box 407, Festus, Missouri, 63028.

(Vulture VIII, continued)

Then pull the rubber band over the pod and onto the rear edge of the pylon. Do this just before flying, or you will ruin your rubber band.

As for engines, use a 1/4A3-2T for Gnat, a 1/2A3-2T for Hornet, and an A3-4T for Sparrow.

At apex the engine charge burns thru the thread, allowing the pod to shift back, changing the center of gravity from boost to glide.

Post Script

For Gnat, use 1/32" balsa for all tail surfaces and 1/16" balsa for the wing.

(Trimming, continued)

from a hand toss.) This is about 1 1/2 full turns at a 25 foot radius, from top of its flight.

This method will work for any standard B/G's, canards, swing-wings, and front-engine R/G's. It will not work with delta wings (like the Estes Orbital Transport).

There is only one disadvantage with throwing a glider like this - you can break it. Indeed, I break my gliders on the average of once before each first flight, the most common damage being a broken rudder or a snapped fuselage. If you're really uptight about getting some damage, you can do two things; 1) Lose at contests, and risk totaling your model in a real flight, or 2) Practice on a crummy or cheap glider, and build your good models only with epoxy. Actually, if your glider can't endure all but the most severe bad throws, then it probably wouldn't stand up to thrust anyway. Far above any damage your glider might receive, after all this, you'll have a glider at its best.

A final note. This is an accumulation of various things I've read and experienced. I do not claim to be the world's best trimmer (maybe 2nd or 3rd. . .). If for some reason you have a problem, you can write me care of *Impulse*. Just enclose a stamp.

(Clipper Conversion, continued)

sheets at least 1/16" thick. Carefully cut the fins from the plastic sheets. Test fit the fins and trim to fit.

I put the fins on by painting a very fine layer of epoxy on the glue joint, then hold the two parts together until the epoxy has

(CapCom, continued)

There was nothing to do but call each of the guests one by one. "The cat ate some of the fish and died," she said, careful not to mention that he had sampled the food before they did. "The newspaper said there has been some bad fish in the area. My husband and I are taking no chances. We are going to the hospital and get our stomachs pumped!"

The emergency room was almost deserted in the wee hours of the morning except for eight persons who had gone there for a common and degrading purpose: To get their stomachs pumped.

It was daylight when the hostess finally got in bed, and it seemed as if she had just dropped off to sleep when the doorbell roused her to her senses. She put on her robe and went down to see who it was.

"I'm sorry I killed your cat," the neighbor said, "but he dashed under the wheels of my car as I pulled into my driveway last night. I brought him over here, but I noticed that you had guests, and I didn't want to spoil your evening with a dead cat. So I just laid him by your back door. This morning, I decided to come over and confess to what I had done."

hardened. I then placed fillets on either side of the fins. Be careful when you put on the fillets as you might break off the fin.

The recovery system should be a parachute at least 18" across. Installation in conventional.

This bird is heavy, so don't use anything below C6-3's and use a rod extension.

You should get a pretty good flight out of the Clipper. It takes time and a little skill, but I can assure you that you will be impressed with the result.

