

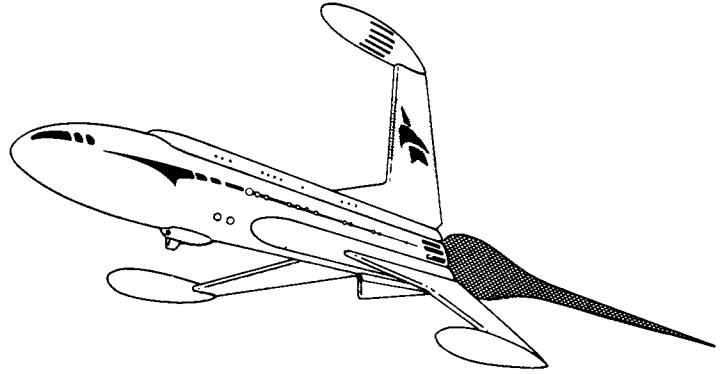

A SUBSIDIARY OF DAMON

Model Rocketry



CUSTOM PARTS CATALOG

**FEATURING 100's OF DIFFERENT
PARTS & ACCESSORIES FOR EVERY
IMAGINABLE DESIGN**

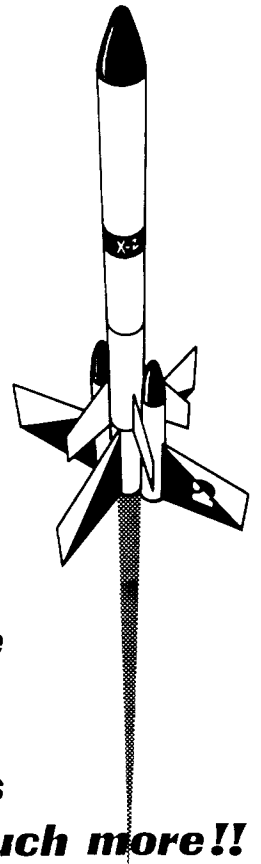
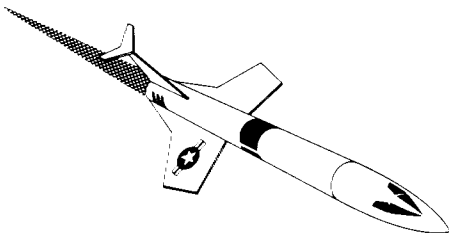
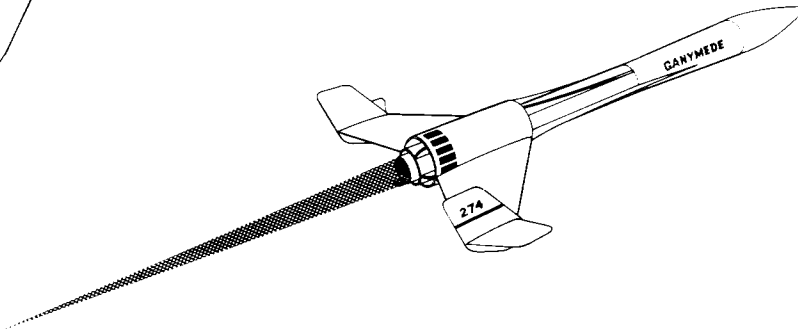
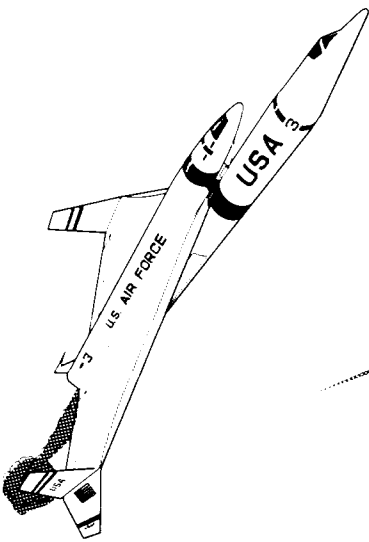
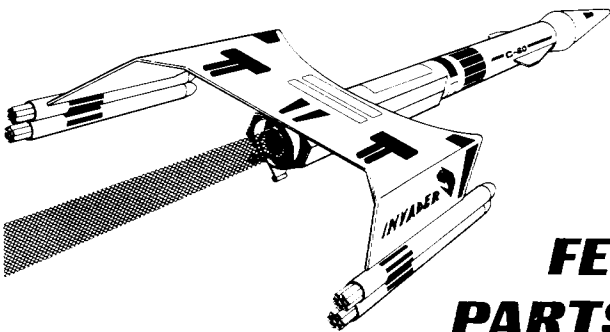

PLAN AND BUILD:

- ★ **Competition Vehicles**
 - ★ **Scale Models**
 - ★ **Exotic Designs**
 - ★ **Multi-Stagers**
 - ★ **High Performance Boost Gliders**
 - ★ **Mini-Birds**
 - ★ **R & D Projects**
- and much, much more!!**

CAT. NO. P741



CUSTOM PARTS CATALOG

INTRODUCTION

Once you have constructed several model rocket kits and have become familiar with the basic Estes Technical Reports, you will no doubt have a variety of ideas for unique designs of your own. Your far-out thoughts on high performance vehicles, exotic designs, and precisely detailed scale models can become a reality with the Estes "Custom Parts Catalog." The components needed to build these and a multitude of other custom designs are featured in the following pages. The original design below illustrates how the various types and sizes of nose cones, adapters, body tubes, ring sets, and fins can be used to construct a variety of shapes and styles.

Nearly all matching Estes parts have the same series identification number. Those which do not feature an additional explanation as to where they can be used. Normally, parts listing the same series I.D. number will be interchangeable with each other. For instance, a No. 20 body tube (BT-20) would mate with a No. 20A balsa nose cone (BNC-20A), a No. 20C payload section (PS-20C), or a No. 20B engine block (EB-20B). Further a No. 2060 tube adapter (TA-2060) will adapt a BT-20 to a BT-60 and a No. 5055 centering ring (AR-5055) will center a BT-50 within a BT-55. By using balsa or paper adapters, almost any combination of parts can be joined together.

Although most measurements given in this catalog are stated in English figures, they can be easily converted to their metric equivalents by using the table below.

CONVERSION TABLE			
MULTIPLY	X	BY	= TO OBTAIN
inches		25.4	millimeters
inches		2.54	centimeters
millimeters		0.0394	inches
centimeters		0.3937	inches
ounces		28.35	grams
ounces		0.02835	kilograms
grams		0.0353	ounces
kilograms		35.3	ounces
feet		30.48	centimeters
pounds		453.592	grams

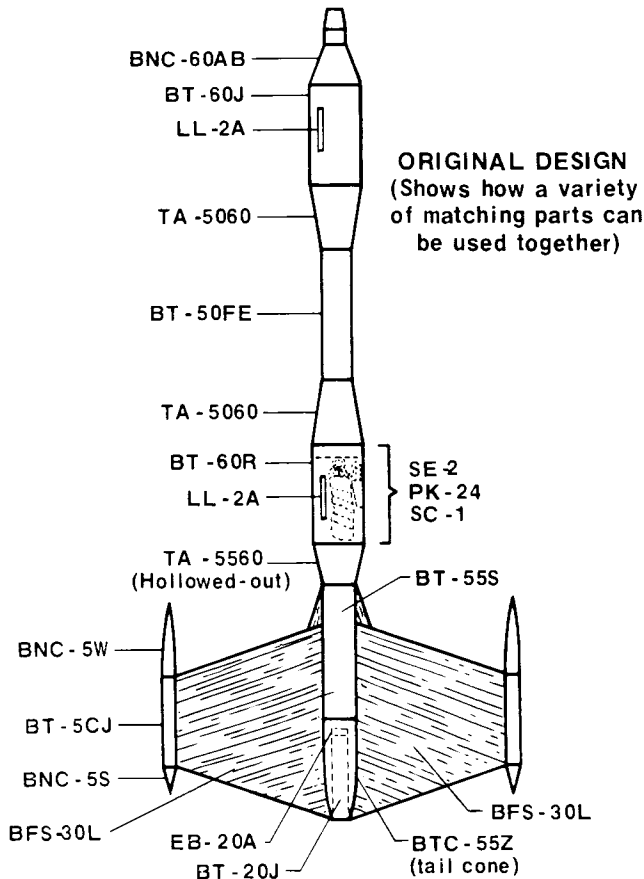

SHIPPING INFORMATION

ORDERING INFORMATION

Use MRN Order Form or standard Estes Order Form for ordering. If additional space is required, use a separate sheet of paper.

POSTAGE-PRIORITY MAIL

All retail orders are shipped postpaid in U.S. by regular land mail, UPS, or by the customer's choice of carrier which may require additional postage. For extra rapid delivery, you may request Priority Mail (Air Mail) service. Total up the shipping weights on the items you are ordering, then find the amount to allow for extra postage on the chart below. When your order is processed you will be charged only for the difference between regular parcel post and priority mail—any excess will be refunded.

PAYMENT ON ORDERS

There will be a 45c handling charge on all orders under \$6.00. Full payment must accompany all orders. Please send all remittances by either check or money order. Please, no C.O.D. orders. All prices are subject to change without notice.

ATTENTION ROCKETEERS

We would like to hear your suggestions for parts not currently listed in this catalog which you would like to see us offer.

Just send your suggestions with your next Estes order or mail them to:

Estes Industries
 Rocketeer Communications Dept.
 Penrose, Colorado 81240

INDEX

SECTION	PAGE
Paper Body Tubes	3
Plastic Body Tubes	3
Stage Couplers	3
Balsa Fin Stock	3
Plastic Fin Material	3
Die Cut Fins	4
Customizing Accessories	4 & 5
Balsa Adapters	6
Paper Adapters	6
Centering Rings	6
Engine Blocks	6
Engine Holders	6
Engine Mounts	6
Launch Lugs	6
Balsa Nose Cone Stock	7
Plastic Nose Cones	7
Plastic Fin Units	7
Nose Cone Weights	7
Balsa Nose Blocks	7
Payload Sections	7
Recovery Supplies	8
Cold Propellant Accessories	8
Aerial Camera Parts	8
Balsa Nose Cones	9
Construction Supplies	10
Decals	11
Design of the Month Plans	12
DOM CONTEST	12
"BONUS COUPONS"	12

NOTE: For information on parts not listed in this catalog see Estes Model Rocketry Catalogs No.732 or 741 or write to :



Estes Industries
 Customer Service Department
 Penrose, Colo. 81240

PAPER BODY TUBES

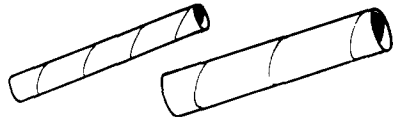

CAT. NO.	NAME	PRICE	LENGTH	INSIDE DIA.	OUTSIDE DIA.	WALL THICK.	WT. IN OZ. NET	SHIP
30300	BT-3H	\$.10	3"	0.349"	0.375"	0.013"	.028	1
30302	BT-5	\$.30	18"	0.515"	0.541"	0.013"	.219	11
30304	BT-5BJ	\$.10	2"	0.515"	0.541"	0.013"	.025	1
30306	BT-5P	\$.15	5.1"	0.515"	0.541"	0.013"	.062	4
30308	BT-5T	\$.10	1.5"	0.515"	0.541"	0.013"	.018	1
30310	BT-5CJ	\$.10	3"	0.515"	0.541"	0.013"	.037	1
30316	BT-20	\$.30	18"	0.710"	0.736"	0.013"	.288	11
30318	BT-20AE	\$.10	1.5"	0.710"	0.736"	0.013"	.021	1
30320	BT-20B	\$.15	8.65"	0.710"	0.736"	0.013"	.138	4
30322	BT-20D	\$.15	6.5"	0.710"	0.736"	0.013"	.104	4
30324	BT-20G	\$.10	3.5"	0.710"	0.736"	0.013"	.056	4
30326	BT-20J	\$.10	2.75"	0.710"	0.736"	0.013"	.044	4
30330	BT-20L	\$.20	12"	0.710"	0.736"	0.013"	.207	4
30332	BT-20DJ	\$.15	4"	0.710"	0.736"	0.013"	.056	4
30334	BT-20M	\$.10	2.25"	0.710"	0.736"	0.013"	0.36	4
30338	BT-30	\$.30	9"	0.725"	0.765"	0.021"	.270	4
30340	BT-30A	\$.15	3.5"	0.725"	0.765"	0.021"	.105	4
30342	BT-30B	\$.20	6.125"	0.725"	0.765"	0.021"	.184	4
30344	BT-30C	\$.20	5.5"	0.725"	0.765"	0.021"	.165	4
30346	BT-30F	\$.25	7"	0.725"	0.765"	0.021"	.210	4
30348	BT-30J	\$.10	2.75"	0.725"	0.765"	0.021"	.082	4
30350	BT-30K	\$.10	2.34"	0.725"	0.765"	0.021"	.077	4
30351	BT-48BE	\$.10	2.5"	0.902"	.928"	0.013"	.042	4
30352	BT-50	\$.40	18"	0.950"	0.976"	0.013"	.378	11
30354	BT-50AE	\$.10	1.5"	0.950"	0.976"	0.013"	.315	6
30356	BT-50AH	\$.10	1.875"	0.950"	0.976"	0.013"	.039	4
30358	BT-50EE	\$.20	5.5"	0.950"	0.976"	0.013"	.112	4
30359	BT-50FE	\$.25	6.5	0.950"	0.976"	0.013"	.130	4
30360	BT-50H	\$.25	7.75"	0.950"	0.976"	0.013"	.163	4
30362	BT-50J	\$.15	2.75"	0.950"	0.976"	0.013"	.058	4
30364	BT-50KE	\$.35	15"	0.950"	0.976"	0.013"	.305	6
30366	BT-50L	\$.30	12.7"	0.950"	0.976"	0.013"	.242	5
30368	BT-50S	\$.20	4"	0.950"	0.976"	0.013"	.084	4
30370	BT-50V	\$.35	16.5"	0.950"	0.976"	0.013"	.350	6
30372	BT-50W	\$.30	9.5"	0.950"	0.976"	0.013"	.200	5
30374	BT-51CI	\$.20	3.875"	0.984"	1.011"	0.013"	.088	4
30376	BT-51N	\$.35	12.420"	0.984"	1.011"	0.013"	.273	4
30378	BT-52AG	\$.15	2.1"	0.988"	1.114"	0.063"	.046	4
30380	BT-52S	\$.20	3.938"	0.988"	1.114"	0.063"	.081	4
30382	BT-55	\$.65	18"	1.283"	1.325"	0.021"	.672	11
30384	BT-55IJ	\$.35	9"	1.238"	1.325"	.021"	.368	11
30386	BT-55J	\$.15	2.75"	1.283"	1.325"	0.021"	.109	4
30388	BT-55KG	\$.60	16.69"	1.283"	1.325"	0.021"	.665	11
30390	BT-55S	\$.20	4"	1.283"	1.325"	0.021"	.268	4
30392	BT-55V	\$.60	16.35"	1.283"	1.325"	0.021"	.687	11
30394	BT-58	\$.50	12.75"	1.498"	1.540"	0.021"	.592	11
30396	BT-60	\$.70	18"	1.595"	1.637"	0.021"	.960	11
30398	BT-60AD	\$.60	14"	1.595"	1.637"	0.021"	.683	11
30402	BT-60AJ	\$.40	10"	1.595"	1.637"	0.021"	.480	11
30406	BT-60D	\$.50	11"	1.595"	1.637"	0.021"	.583	11
30408	BT-60FG	\$.30	6.7"	1.595"	1.637"	0.021"	.340	6
30410	BT-60HE	\$.40	8.5"	1.595"	1.637"	0.021"	.441	11
30412	BT-60J	\$.15	2.75"	1.595"	1.637"	0.021"	.146	6
30414	BT-60K	\$.30	7"	1.595"	1.637"	0.021"	.371	6
30416	BT-60KF	\$.65	16.1"	1.595"	1.637"	0.021"	.805	11
30418	BT-60R	\$.25	5"	1.595"	1.637"	0.021"	.265	6
30420	BT-63CJ	\$.30	3"	1.639"	1.681"	0.021"	.151	6
30422	BT-63Y	\$.15	1.340"	1.639"	1.681"	0.021"	.070	4
30424	BT-70	\$.90	17.5"	2.175"	2.217"	0.021"	1.300	14
30428	BT-70H	\$.40	7.15"	2.175"	2.217"	0.021"	.473	11
30430	BT-70V	\$.60	10.6"	2.175"	2.217"	0.021"	.735	11
30172	RT-70	\$.20	.680"	2.175"	2.217"	0.021"	.142	3
30432	BT-80	\$.60	7.6"	2.560"	2.600"	0.021"	.637	11
30174	RT-99D	\$.25	.391"	3.668"	3.79"	0.021"	.142	3
30434	BT-100CES	\$.40	3.5"	3.702"	3.744"	0.021"	.399	11
30436	BT-100Z	\$ 1.15	10.89"	3.702"	3.744"	0.021"	1.330	14
30438	BT-101	\$ 1.75	16.5"	3.896"	3.938"	0.021"	1.974	16
30440	BT-101K	\$ 1.00	7.59"	3.896"	3.938"	0.021"	.910	11
30442	BT-101T	\$.35	2.78"	3.896"	3.938"	0.021"	.333	6

PLASTIC BODY TUBES

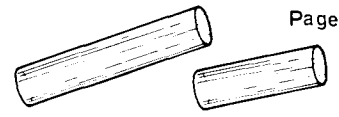

CAT. NO.	NAME	PRICE	LENGTH	INSIDE DIA.	OUTSIDE DIA.	WALL THICK.	WT. IN OZ. NET	SHIP
30312	BT-10*	\$.30	9"	0.710"	0.720"	0.005"	.088	4
30314	BT-10H	\$.20	3.062"	0.710"	0.720"	0.005"	.029	1
30602	PST-20	\$.35	8"	0.710"	0.736"	0.013"	.168	4
30604	PST-20J	\$.15	2.75"	0.710"	0.736"	0.013"	.058	4
30620	PST-50FJ	\$.30	6"	0.950"	0.976"	0.013"	.193	5
30608	PST-50S	\$.25	4"	0.950"	0.976"	0.013"	.110	4
30610	PST-59CJ	\$.25	3"	1.533"	1.585"	0.201"	.217	4
30600	PCT-60	\$.20	1.525"	1.576"	1.595"	0.023"	.011	1
30614	PST-60R	\$.50	5"	1.595"	1.637"	0.021"	.265	6
30618	CM-8EA**	\$.60	4.180"	1.685"	1.785"	0.021"	.368	6
30616	PST-65R	\$.55	5"	1.595"	1.641"	0.023"	.368	7

* Spiral-wound mylar plastic tube

** Black opaque plastic tube

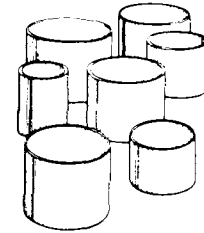

STAGE COUPLERS

For multi-staging, joining body tubes, positioning adapter rings, etc. Make perfect guides for cutting body tubes and sanding cut edges of body tubes, too.

CAT. NO.	NAME	PRICE	FITS	OUTSIDE DIA.	INSIDE DIA.	LENGTH	WT. IN OZ. NET	SHIP
30252	JT-5C	\$.15	BT-5	0.513"	0.455"	3/4"	.020 oz.	3oz.
30254	JT-20C	\$.15	BT-20	0.708"	0.650"	3/4"	.027 oz.	3oz.
30256	JT-30C	\$.10	BT-30	0.724"	0.650"	3/4"	.030 oz.	3oz.
30258	JT-50B	\$.15	BT-50	0.845"	0.814"	1"	.018 oz.	3oz.
30260	JT-50C	\$.20	BT-50	0.949"	0.920"	1"	.051 oz.	3oz.
30262	JT-55C	\$.20	BT-55	1.28"	1.25"	1.3"	.088 oz.	3oz.
30264	JT-60BE	\$.20	BT-60	1.55"	1.46"	1/4"	.026 oz.	3oz.
30266	JT-60C	\$.20	BT-60	1.59"	1.55"	1-1/2"	.124 oz.	3oz.
30268	JT-60P*	\$.20	BT-60	1.589"	1.558"	1-1/2"	.102 oz.	3oz.
30270	JT-70A	\$.25	BT-70	2.175"	2.115"	1-1/4"	.140 oz.	3oz.
30272	JT-70D	\$.20	BT-70	2.43"	2.18"	5/8"	.087 oz.	3oz.
30274	JT-80C	\$.25	BT-80	2.55"	2.50"	1"	.105 oz.	3oz.
30276	JT-101C	\$.30	BT-101	3.96"	3.77"	1"	.148 oz.	3oz.

Plastic

BALSA FIN STOCK

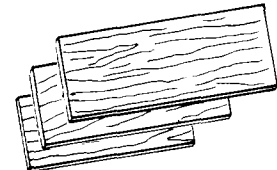

CAT. NO.	NAME	PRICE	DIMENSIONS	WT. IN OZ. AVG.	SHIP
3162	BFS-10	3 for \$.50	1/32" x 3" x 9"	.065	4oz.
32104	BFS-20B	2 for \$.10	1/16" x 1/2" x 6"	.015	2oz.
3164	BFS-20	3 for \$.40	1/16" x 3" x 9"	.130	4oz.
3166	BFS-20L	3 for \$.55	1/16" x 3" x 12"	.173	6oz.
32112	BFS-30LA	3 for \$.15	3/32" x 3" x 12"	.003	6oz.
3168	BFS-30	3 for \$.45	3/32" x 3" x 9"	.150	4oz.
3170	BFS-30L	3 for \$.60	3/32" x 3" x 12"	.200	6oz.
32114	BFS-30W	\$.75 each	3/32" x 4" x 18"	.50	16oz.
3172	BFS-40	3 for \$.55	1/8" x 3" x 9"	.200	6oz.
3174	BFS-40L	3 for \$.70	1/8" x 3" x 12"	.265	6oz.
32146	BFS-40W	\$.80 each	1/8" x 4" x 18"	.73	16oz.
32144	BFS-60S	3 for \$.20	3/16" x 1/2" x 3.7"	.020	2oz.

PLASTIC FIN MATERIAL

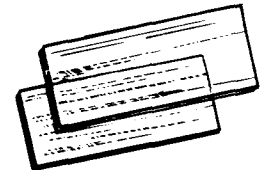

CAT. NO.	NAME	PRICE	DIMENSIONS	WT. IN OZ. NET	SHIP
3185	CFS-20	\$.35 each	3" x 9" x .02"	0.462	1oz.
3186	CFS-20A	3 for \$.25	1 1/2" x 9" x .02"	0.231	1oz.
3187	CFS-40	\$.60 each	3" x 9" x .04"	0.823	1oz.

DIE CUT BALSA FINS

NO.	CAT. NO.	NAME-DESCRIPTION	PRICE	SIZE	SHIP. WT. OZ.
1	32206	Mars Snooper (BF-20A)	\$.60	1/16" x 3" x 9"	4
2	32210	Alpha II (BF-25)	\$.35	3/32" x 3" x 12"	6
3	32218	Shrike (BF-46)	\$.50	3/32" x 3" x 9"	4
4	32220	Cherokee-D (BF-47)	\$.60	3/32" x 4" x 9"	4
5	32222	Bandit (BF-48)	\$.55	3/32" x 3" x 9"	4
6	32224	Sprint (BF-49)	\$.40	3/32" x 3" x 9"	4
7	32226	Interceptor (BF-50A)	\$.65	1/8" x 3" x 12"	6
8	32228	Interceptor (BF-50B)	\$.50	3/32" x 3" x 9"	4
9	32230	Omega (BF-52)	\$.90	1/8" x 4" x 12"	6
10	32232	Skydart (BF-57A)	\$.95	3/32" x 4" x 18"	16
11	32234	Skydart (BF-57B)	\$.55	3/32" x 3" x 12"	6
12	32236	Demon (BF-58)	\$.60	1/8" x 3" x 12"	6
13	32238	Red Max (BF-M2)	\$.60	1/8" x 3" x 12"	6
14	32240	Patriot (BF-M3)	\$.60	1/8" x 3" x 12"	6
15	32242	Starship Vega (BF-M4A)	\$.55	1/8" x 3" x 12"	6
16	32244	Starship Vega (BF-M4B)	\$.20	3/32" x 3" x 12"	6
17	32246	Bomarc (BF-M5)	\$.95	3/32" x 4" x 18"	16
18	32248	Mini-Bomarc (BF-TK5)	\$.50	1/16" x 3" x 9"	4
19	32250	Scamp (BFL-1)	\$.55	3/32" x 3" x 9"	4
20	32252	Yankee Five (BFL-2)	\$.55	3/32" x 3" x 9"	4
21	32254	Marauder (BFL-3)	\$.55	3/32" x 3" x 9"	4
22	32256	Honest John (BFL-4)	\$.60	3/32" x 3" x 9"	4
23	32258	Teros (BFL-5)	\$.60	3/32" x 3" x 9"	4
24	32260	Shark (BFL-6)	\$.60	3/32" x 3" x 9"	4
25	32270	Wolverine	\$.30	1/16" x 3" x 6"	2
26	32271	Aero-Hi	\$.20	1/16" x 1 1/2" x 6"	2
27	32272	Rogue	\$.20	1/16" x 3" x 4"	2
28	32273	Little John	\$.20	1/16" x 3" x 3"	2

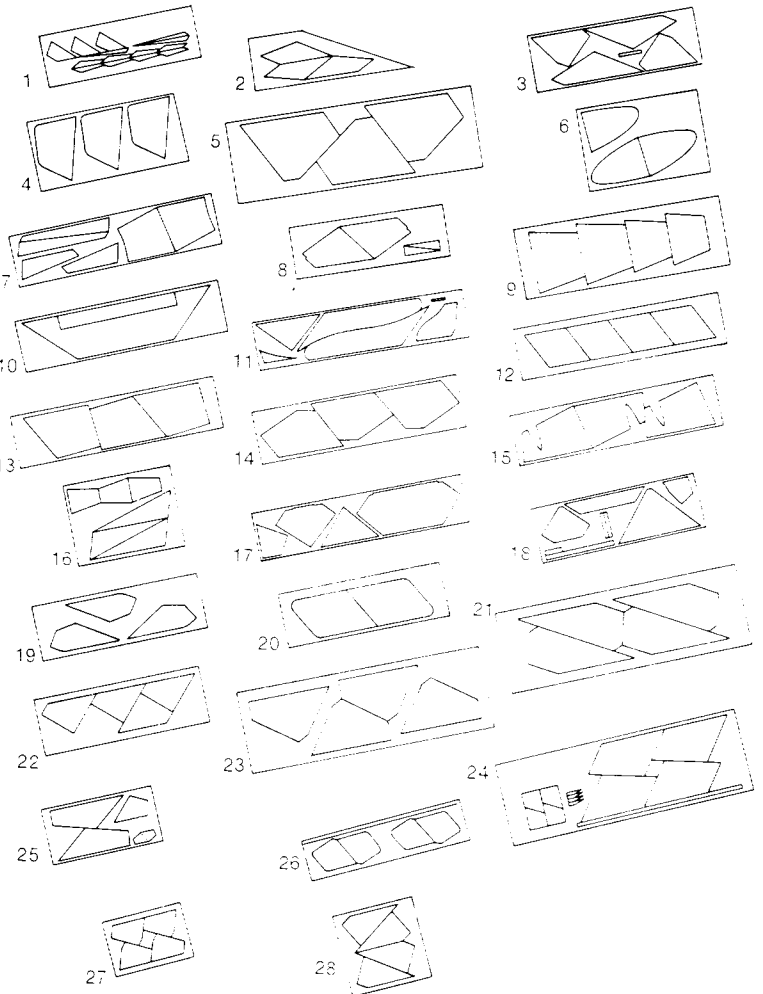

CUSTOMIZING ACCESSORIES

NO.	CAT. NO.	DESCRIPTION	SHIP. WT.	PRICE
1	35300	Nozzle (7010) —For some cold propellant vehicles. Excellent for simulated exhaust nozzle on exotic and scale models.	1 oz.	\$.40
2	9014	Estes Mini-Brute Display Stand —Features kit and builder name panels.	1 oz.	\$.15
3	70510	Balsa Pylon (BPM-5) —2 13/16" x 7/16", 1/4" width at widest point. Airfoiled round at one end and pointed at the other.	1 oz.	\$.30
4	45010	Interceptor Parts Set (PRP-50) —Exotic nose cone, wing pod tips and tail piece.	5 oz.	\$1.35
5	45011	Sandhawk Parts Set (PRP-51) —Scale payload section, nose cone, fins, tail section and antenna.	5 oz.	\$1.35
6	45012	Saros Parts Set (PRP-54) —2 nose cone halves, 2 adapter halves, and 2 fin unit halves.	4 oz.	\$1.50
7	33100	Plastic Parts for Saturn V (K-36) (MPS-36) —Contains scale exhaust nozzles, escape tower pieces, fairing strips, exhaust parts, and 100th scale Apollo Capsule.	5 oz.	\$3.50
8	3180	Bomarc Vacuform Parts Set —2 nacelle cones with plastic liners and body tube raceway.	6 oz.	\$.95
9	1422	Apollo Capsule (NCK-29) —6.6" long, fits BT-70, average weight 0.36 oz., for Saturn 1B and Little Joe II kits.	5 oz.	\$1.85

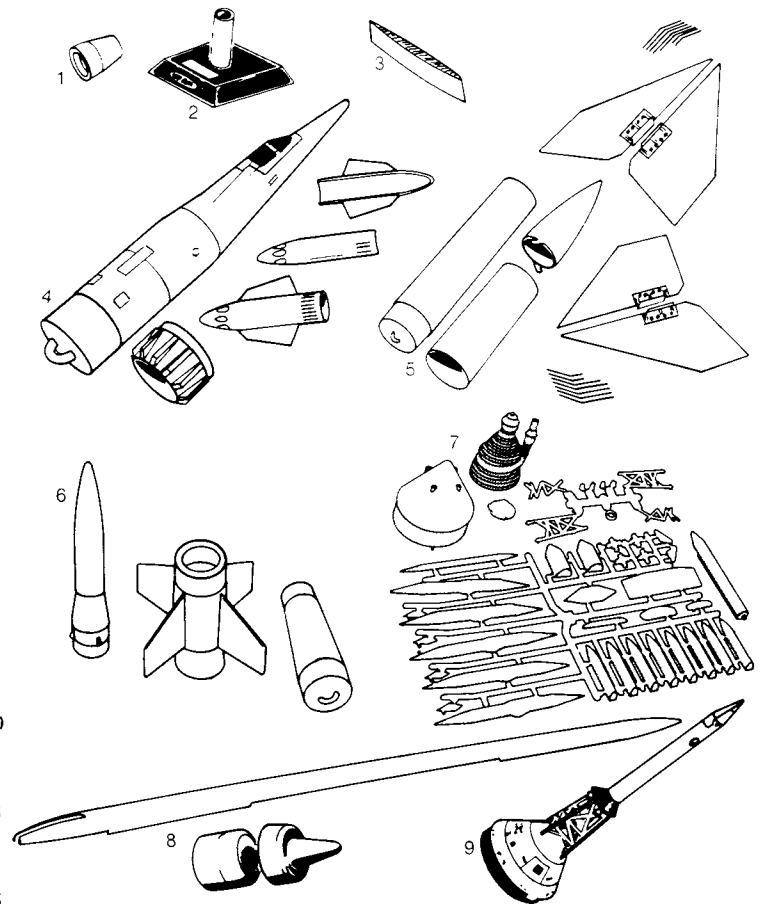

- 10 1423 **Mercury Capsule (PSM-1)**—1.8" diameter x 3.2" long with capacity for small payloads. Includes full set of adapters to fit most body tubes. 3 oz. \$1.10
- 11 30002 **Gemini-Titan Adapter Set (TA-21)**—Various adapter rings including 2 for a twin engine cluster. Centers BT-60 in BT-70, BT-20 in BT-70, BT-20 in BT-60, two BT-20's in BT-70. 1 oz. \$.35
- 12 30004 **Honest John Paper Adapters (TA-27)**—Adapter rings for BT-20 and BT-50. 1 oz. \$.10
- 13 3320 **Saturn 1B Adapter Set (TA-29-1, 2, & N)**—Various adapter rings and customizing die-cuts. Centers BT-50 in BT-70, BT-70 in BT-100, BT-60 in BT-70, BT-50 in BT-63, four BT-20's in BT-101, BT-63 in BT-100, BT-50 in BT-70, BT-50 in BT-63. 3 oz. \$1.00
- 14 3321 **Saturn V Adapter Set (TA-36, NF)**—Assorted rings. Centers BT-50 in BT-101, BT-63 in BT-101, BT-50 in BT-63, BT-80 in BT-101. 2 oz. \$.90
- 15 30016 **Mercury Redstone Paper Adapter (TA-41)**—Adapter rings and assorted custom die-cuts. Centers BT-20 in BT-60. 1 oz. \$.20
- 16 30042 **Mars Lander Adapter Set (TA-43ABC)**—Assorted customizing die-cuts and adapter rings. Centers BT-60 in BT-100, BT-20 in BT-60, BT-20 in BT-100, plus many other unusual combinations. 4 oz. \$2.00
- 17 30028 **Shrike Paper Adapters (TA-46)**—For BT-20 to tail cone. 1 oz. \$.10
- 18 30030 **Bandit Paper Adapters (TA-48)**—Centers BT-20 in BT-55. 1 oz. \$.20
- 19 30032 **Interceptor Paper Adapters (TA-50)**—BT-55 marking guide, adapter rings for centering BT-20 in BT-55. 1 oz. \$.30
- 20 30034 **Sandhawk Paper Adapters (TA-51)**—Die-cuts, BT-55 marking guide, adapter rings for centering BT-50 in BT-55. 1 oz. \$.25
- 21 3325 **Skydart Paper Adapter (TA-57)**—Simulated engine nacelles. 1 oz. 2 for \$.50
- 22 30038 **Starship Vega Paper Adapter (TA-M4)**—Tube marking guide for BT-50 and landing shock pads. 1 oz. \$.25
- 23 30040 **Bomarc Paper Adapter (TA-M5)**—Tube marking guide for BT-55 and adapter rings for centering BT-20 in BT-55. 1 oz. \$.25
- 24 30044 **Birdie Paper Adapter**—Adapter Ring centers BT-5 in BT-60. 1 oz. 2 for \$.20
- 25 3340 **Saturn 1B Wrap Around Set (SP-29B1, 2, 3, 4 & 5)**—Corrugated skin panels. 3 oz. \$.90
- 26 3341 **Little Joe II Wrap Around Set (SP-301 & 2)**—Corrugated skin panels. 2 oz. \$.40
- 27 3343 **Saturn V Wrap Around Set (SP-36W 1 thru 8)**—Corrugated skin panels, reducer sections, and engine shrouds. 4 oz. \$2.25
- 28 3345 **Mars Lander Wrap Around Set (EW-43 A thru F)**—Corrugated and detailed skin reducer sections. 3 oz. \$1.85
- 29 37656 **Shrike Wrap Arounds (EW-46ABC)**—Corrugated skin panel and simulated nozzle cone. 1 oz. \$.35
- 30 37657 **Sprint Wrap Around (EW-49)**—Boat tail cone section. 1 oz. \$.20

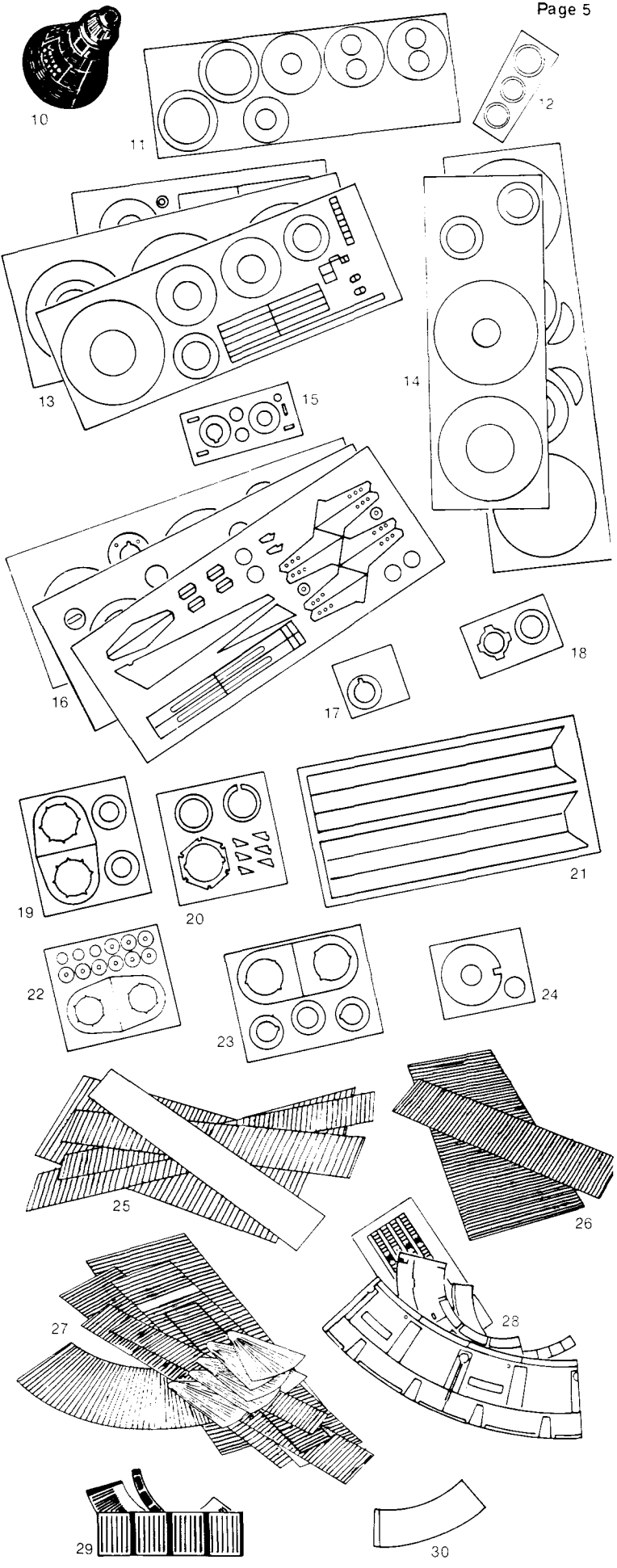

BALSA NOSE CONE STOCK

CAT. NO.	NAME	PRICE	DIMENSIONS	SHIP WT.
3200	Nose Cone Stock (NCS-1A) Includes Nose Cone Dowel NCD-2	\$.20	6" length 1" x 1" blocks	1oz.
3202	Nose Cone Stock (NCS-2A) Includes Nose Cone Dowel NCD-2	\$.25	6" length 2" x 2" blocks	3oz.
32052	Nose Cone Dowel (NCD-2)	3 for \$.15	1/4" x 2"	2oz.

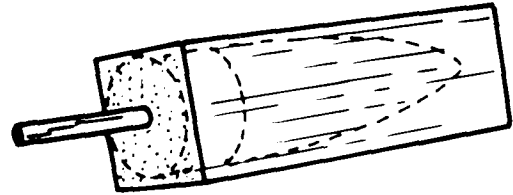

PLASTIC NOSE CONES

FITS BT	CAT. NO.	NAME	PRICE	DIMENSIONS	COLOR	WT. IN OZ. NET SHIP
BT-50 1	71008	PNC-50K	\$.50	2 5/8" .974" .5"	Red	.228 2
BT-50 2	45015	CPNC-50K	\$.50	2 5/8" .974" .5"	Clear	.228 2
BT-50 3	71004	PNC-M1	\$.65	2 5/8" .974" .5"	Chrome Silver	.231 2
BT-60 4	71014	PNC-60AH	\$1.00	6 3/4" 1.627" .875"	Black	1.40 3
BT-60 5	71015	PNC-60L	\$.70	2 1/2" 1.627" .750"	White	.239 3

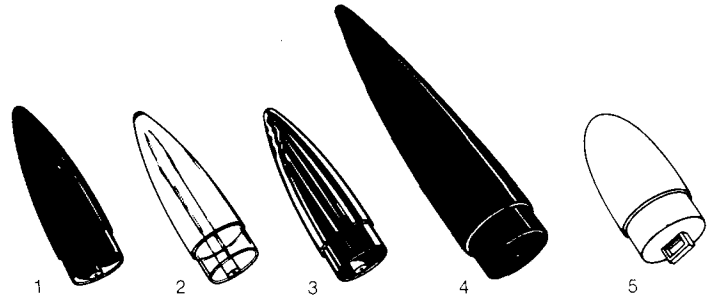

PLASTIC FIN UNITS

FITS BT	CAT. NO.	NAME	PRICE	NO. FITS	OVERALL LENGTH	FITS ENGINE	COLOR	WT. IN OZ. NET SHIP
BT-50 1	32408	PFM-1	\$1.00	3	3 5/8"	Mini or Reg.	Chrome Silver	.480 4
BT-50 2	32406	Phantom Fin Unit	\$.50	3	3 15/16"	Mini or Reg.	Clear	.462 4
BT-50 3	32414	PFS-50A	\$.50	3	3 15/16"	Mini or Reg.	Red	.476 4

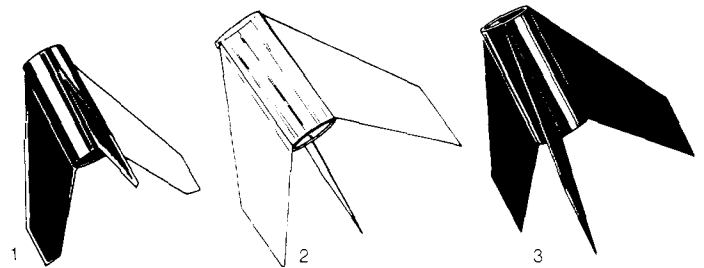

NOSE CONE WEIGHTS

CAT. NO.	NAME	DESCRIPTION	NET WT.	SHIP. WT.	PRICE
2305	Round Nose Cone Weight (NCW-1)	1 1/16" dia. with center hole	.12	1oz.	6 for \$.60
2306	Nose Cone Weight (NCW-2)	7/16" dia. 1/8" center hole	.023	1oz.	20 for \$.90
2307	Strip Nose Cone Weight (NCW-3)	3" x 1/4" x 0.02"	.085	1oz.	10 for \$.60
2308	Nose Cone Weight (NCW-4)	.501 dia. .217"	.354	2oz.	20 for \$.40
2309	Competition Payload Weight (PL-1) N.A.R. Approved	3/4" dia.	1oz.	2oz.	2 for \$1.00

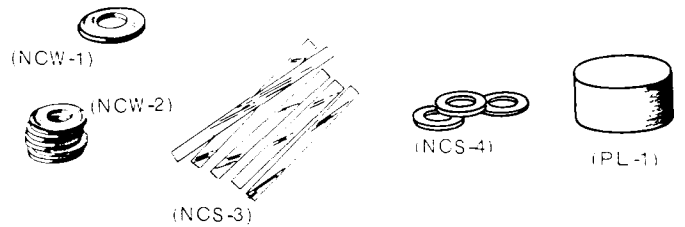

BALSA NOSE BLOCKS

CAT. NO.	NAME	PRICE	FITS	OUTSIDE DIAMETER	LENGTH	WT. IN OZ. NET SHIP
70152	NB-20	\$.30	BT-20	.710"	3/4"	.014 1
70156	NB-30	\$.35	BT-30	.725"	3/4"	.014 1
70158	NB-50	\$.40	BT-50	.950"	1"	.040 4
70160	NB-50L	\$.35	BT-50	.950"	1 3/16"	.077 4
70162	NB-55	\$.45	BT-55	1.283"	1 1/4"	.115 4
70164	NB-60	\$.50	BT-60	1.595"	1 1/2"	.190 4

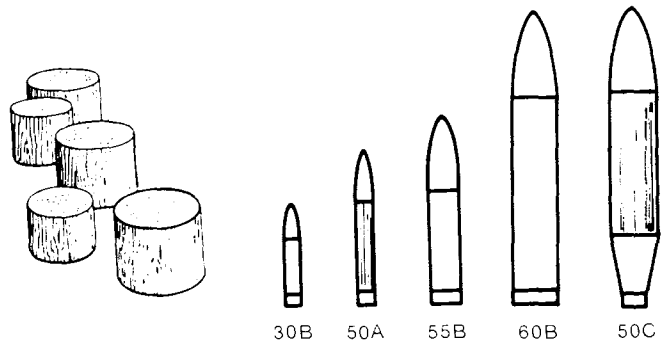

PAYLOAD SECTIONS

CAT. NO.	NAME	PRICE	BODY MATERIAL	FITS	INSIDE DIA.	INSIDE LENGTH	OVERALL LENGTH	WT. IN OZ. NET SHIP
3011	PS-20A	\$.90	Clear Plastic	BT-20	.710"	2"	4.00"	.16 1
3013	PS-20C	\$.95	Clear Plastic	BT-20	.950"	3"	7.30"	.40 1
3015	PS-30B	\$.75	Reg. Tube	BT-30	.725"	2"	3.75"	.24 1
3017	PS-50A	\$.95	Clear Plastic	BT-50	.950"	3"	6.50"	.39 4
3019	PS-50B	\$.80	Reg. Tube	BT-50	.950"	3"	6.50"	.36 4
3021	PS-50C	\$1.95	Clear Plastic	BT-50	1.59"	4"	10.50"	1.00 11
3025	PS-50E	\$1.85	Clear Plastic	BT-50	1.75"	4"	10.50"	1.10 11
3027	PS-55B	\$1.50	Reg. Tube	BT-55	1.28"	3"	7.63"	.53 11
3029	PS-60A	\$1.90	Clear Plastic	BT-60	1.59"	4"	9.50"	.98 11
3031	PS-60B	\$1.80	Reg. Tube	BT-60	1.59"	6"	10.50"	.90 11
3033	PS-60C	\$1.90	Clear Plastic	BT-60	1.75"	4"	9.50"	1.00 11

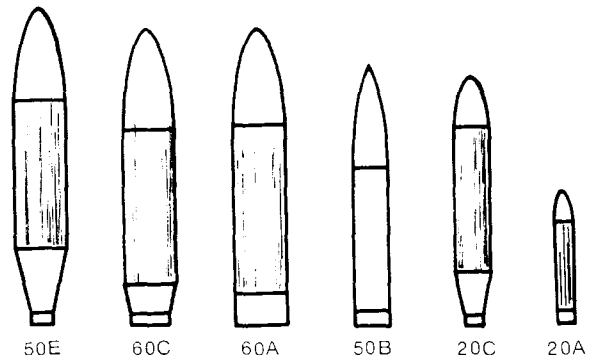

BALSA ADAPTERS

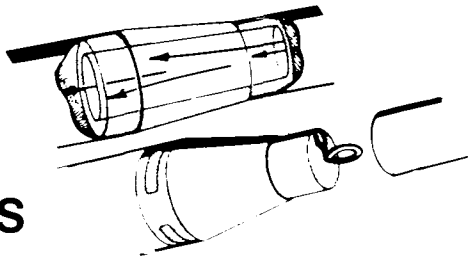

Adapters give flexibility for rocket design. Switch from one size body tube to another for payload capsules, parachute compartments, propulsion sections, etc. Adapters fitting BT-20 can be built up with masking tape to fit BT-30. Any adapter can be hollowed to make a passage for ejection gases. All adapters have at least 1/2" mating surface on each end.

CAT. NO.	NAME	PRICE	MATES TUBES	LENGTH	TAPER LENGTH	WT. IN OZ. NET SHIP
70002	TA-520	\$.30	BT-5 to BT-20	1.75"	0.75"	0.04 1
70004	TA-550	\$.35	BT-5 to BT-50	2.2"	1.0"	0.06 4
70006	TA-2050	\$.40	BT-20 to BT-50	3.0 "	2.0 "	0.15 4
70008	TA-2050A	\$.35	BT-20 to BT-50	2.0 "	1.0 "	0.11 4
70010	TA-2055	\$.45	BT-20 to BT-55	2.5 "	1.5 "	0.22 4
70012	TA-2060	\$1.00	BT-20 to BT-60	3.0 "	2.0 "	0.20 4
70014	TA-5055	\$.60	BT-50 to BT-55	2.0 "	1.0 "	0.60 4
70016	TA-5060	\$1.20	BT-50 to BT-60	2.0 "	2.0 "	0.23 4
70020	TA-5065	\$.70	BT-50 to PST-65	3.0 "	2.0 "	0.26 4
70022	TA-5260	\$1.30	BT-52 to BT-60	5.0 "	4.0 "	0.54 4
70024	TA-5260A	\$.70	BT-52 to BT-60	2.0 "	1.0 "	0.10 4
70026	TA-5260C	\$1.35	BT-52 BT-60	5.0 "	3.865"	0.42 4
70028	TA-5560	\$.65	BT-55 to BT-60	2.2 "	1.0 "	0.25 4
70030	TA-5565	\$.65	BT-55 to PST-65	2.7 "	1.5 "	0.38 4
70032	TA-6065	\$.60	BT-60 to PST-65	2.0 "	0.5 "	0.23 4
70034	TA-6070	\$1.10	BT-60 to BT-70	2.7 "	1.5 "	0.65 4

PAPER ADAPTERS

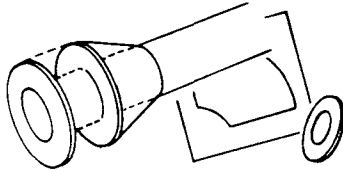

CAT. NO.	NAME	MOUNTS TUBES	SHIP WT.	PRICE
3110	RA-2050	BT-20 in BT-50	2oz.	20 for \$.30
3112	RA-2055	BT-20 in BT-55	2oz.	10 for \$.30
3114	RA-2060	BT-20 in BT-60	2oz.	10 for \$.30
3115	RA-2070	BT-20 in BT-70	2oz.	2 for \$.40
30118	RA-550	BT-5 in BT-50	2oz.	4 for \$.25
30120	RA-560	BT-5 in BT-60	2oz.	4 for \$.30
30132	RA-5060	BT-50 to BT-60	2oz.	4 for \$.35
3121	TA-1	Multi-Purpose Set	2oz.	set \$.40

Includes a total of 20 rings for positioning BT-5 in BT-20; BT-5 and BT-20 in BT-50; and BT-5, B-20, and BT-50 in BT-60. Also three universal tapered shrouds and instructions.

NOTE: See Customizing Accessories Section for a variety of unusual paper adapter combinations.

CENTERING RINGS

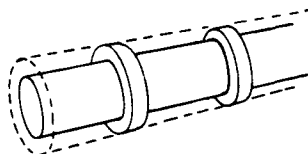

CAT. NO.	NAME	CENTERS TUBES	NET WT.	SHIP. WT.	PRICE
3101	AR-2050	BT-20 in BT-50	.143oz.	3oz.	10 for \$.55
3103	AR-5055	BT-50 in BT-55	0.62oz.	2oz.	4 for \$.35
30162	AR-520	BT-5 in BT-20	.105oz.	1oz.	3 for \$.20

NOTE: See Customizing Accessories Section for a variety of adapter-centering ring combinations.

ENGINE BLOCKS

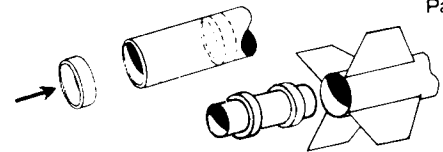

CAT. NO.	NAME	PRICE 3 for	OUTSIDE DIA.	INSIDE DIA.	LENGTH	FITS	WT. IN OZ. NET SHIP
3130	EB-5B	\$.20	.512"	.40"	3 1/6"	BT-5	.175 1
3132	EB-20A	\$.20	.708"	.65"	1 1/4"	BT-20	.009 1
3134	EB-20B	\$.20	.708"	.65"	1 1/8"	BT-20	.005 1
3136	EB-30A	\$.20	.724"	.65"	1 1/4"	BT-30	.010 1

NOTE: Use AR-2050 centering ring as engine block for "D" engines.

ENGINE HOLDERS



CAT. NO.	NAME	PRICE	ENG. TYPE	LENGTH	WIDTH	THICK.	WT. IN OZ. NET SHIP.
3141	EH-2	3 for \$.60	Reg. & D	2.8"	0.100"	0.025"	0.032 1oz.
3143	EH-3	3 for \$.60	Mini	1.8"	0.125"	0.025"	0.022 1oz.
3340	HR-20	3 for \$.20	Strapdown Ring for EH-2 & BT-20J	Combination	.774" dia.	.25" wide	0.035 1oz.

ENGINE MOUNTS

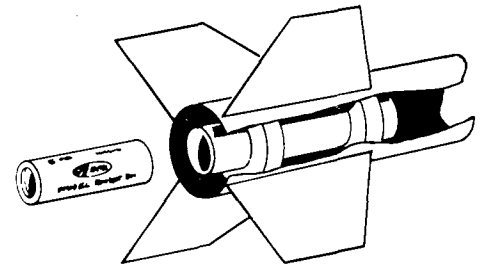

CAT. NO.	NAME	PRICE	ENGINE TYPE	FITS	WT. IN OZ. NET SHIP.
3150	EH-2050	\$.40	For Series I & II Engines—A, B & C Type, 0.60" x 2.75"	BT-50	0.1 5oz.
3151	EH-2055	\$.40		BT-55	0.14 5oz.
3152	EH-2060	\$.40		BT-60	0.17 5oz.
3153	EM-520	\$.35	For "T" Series Mini-Engines .5" x 1.75"	BT-20	0.09 5oz.
3154	EM-2050	\$.45	Special Purpose Quick-Change Conversion Mount from Series IV Engine to Series I & II Engines	BT-50	0.19 5oz.
3155	EM-5063	\$.60	For Series IV Engines D Type, 0.945" x 2.75"	Saturn V or BT-60	0.4 5oz.

LAUNCH LUGS

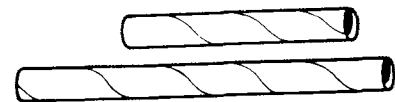

CAT. NO.	NAME	PRICE	INSIDE DIA.	FITS ROD	LENGTH	SHIP WT.
2321	LL-2A	12 for \$.50	5/32"	1/8"	1 1/4"	1oz.
2323	LL-2B	10 for \$.50	5/32"	1/8"	2 3/8"	1oz.
2325	LL-2C	6 for \$.60	5/32	1/8"	5"	1oz.
2327	LL-2D	4 for \$.60	5/32"	1/8"	8"	1oz.

NOTE: See "Cold Propellant Accessories" item No. 3436 for plastic launch guide.

RECOVERY SUPPLIES

CAT. NO.	NAME	DIMENSIONS		WEIGHT	SHIP.	PRICE
		OR DIA.	NET			
2260	Parachute (PK-8)	8" dia.	.035 oz.	2 oz.		\$.35
2262	Ready-Made Parachute (PK-10)	10" dia.	.074 oz.	2 oz.		\$.35
2263	Parachute (PK-12)	12" dia.	.078 oz.	2 oz.		\$.40
2266	Parachute (PK-18)	18" dia.	.144 oz.	2 oz.		\$.45
2270	Parachute (PK-24)	24" dia.	.298 oz.	2 oz.		\$.70
38205	Nylon Parachute (PK-36S) Preassembled	36" dia.	1.522 oz.	2 oz.		\$2.00
2259	Aluminized Parachute Material 36" x 36" thick	1.25 mil	.861 oz.	2 oz.		2 for \$1.50
2342	Orange Streamer Material (SM-1) Flame Resistant Crepe Paper	1" x 90"	.092 oz.	1 oz.		6 for \$.80
2344	Orange Streamer Material (SM-2) Flame Resistant Crepe Paper	2" x 90"	.184 oz.	1 oz.		6 for \$.95
2283	Screw Eye (SE-2)	3/4" long	.03 oz. ea.	1 oz.		6 for \$.30
2284	Screw Eye (SE-3)	5/8" long	.01 oz. ea.	1 oz.		6 for \$.30
38256	Shroud Line (SLT-1)	72 yards		5 oz.		\$.50
2291	Snap Swivels (SV-12)	1" long	.01 oz.	1 oz.		12 for \$.80

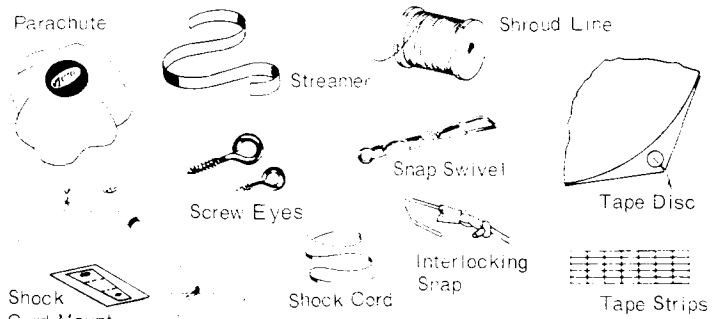

38269	Interlocking Snap (SV-2)	3/4" long	.014 oz.	1 oz.		12 for \$.60
2295	Tape Disc (TD-1)	3/4" dia.		1 oz.		24 for \$.40
2297	Tape Strip (TD-2)	1/4" x 3/4"		1 oz.		70 for \$.60
2298	Tape Disc. (TD-3)	1/2" dia.		1 oz.		24 for \$.30
85730	Shock Cord (SC-1)	1/8" x 18"	.039 oz.	1 oz.		\$.10
85732	Shock Cord (SC-1A)	1/8" x 9"	.031 oz.	1 oz.		\$.10
85734	Shock Cord (SC-1B)	1/8" x 12"	.025 oz.	1 oz.		\$.10
85736	Shock Cord (SC-2)	1/4" x 18"	.078 oz.	1 oz.		\$.15
85738	Shock Cord (SC-2MJ)	1/4" x 30"	.175 oz.	1 oz.		\$.20
85740	Shock Cord (SC-2B)	1/4" x 12"	.066 oz.	1 oz.		\$.15
85744	Shock Cord (SC-3)	1/8" x 36"	.078 oz.	1 oz.		\$.20
900510	Shock Cord Mount (SCM-30)	For BT-30 body tubes and smaller.		1 oz.		32 for \$.25
900511	Shock Cord Mount (SCM-50)	For BT-50 body tubes and larger.		1 oz.		15 for \$.25

COLD PROPELLANT ACCESSORIES

Manual Firing Unit

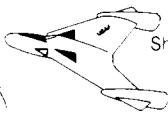
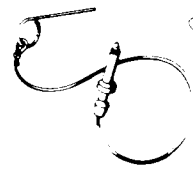

Shrike

ColdPower Engine

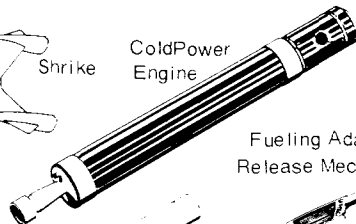

Fueling Adapter & Release Mechanism



J-33 Engine

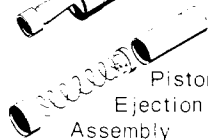

Piston Ejection Assembly

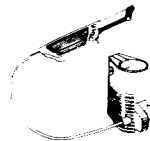

CAT. NO.	NAME	DESCRIPTION	SHIP. WT.	PRICE
3405	Manual Firing Unit (5055)	For launching cold propellant rockets manually by pulling a pin. Unit includes nozzle plug with assembled tether wire and safety pin.	4 oz.	.85
33040	Shrike Jet Plane, (7099)	Styrofoam body only.	10 oz.	\$1.25
33041	XS-1 Plane, (7100)	Styrofoam body only.	10 oz.	\$1.25
80382	J-33 Engine (7092)	1 oz. propellant capacity; .625" dia. x 4 5/16" long fuel chamber for Shrike Jet Plane and XS-1 Space Shuttle.	5 oz.	\$2.25
80360	ColdPower Engine	2.5 oz. propellant capacity, .875" dia. x 6 1/4" fuel chamber, .385" max. dia. x 1 1/16" long nozzle	8 oz.	\$1.75
80361	ColdPower Fueling Adapter & Release Mechanism	For use with No. 80360 Cold Power engine.	4 oz.	\$2.00
2370	Piston Ejection Assembly	For ColdPower Rockets. Includes plastic bulkhead, spring, piston tube, and shock cord.	3 oz.	\$.75

AERIAL CAMERA PARTS

CAMROC (C-1)

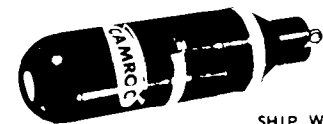

CAT. NO.	NAME	SHIP. WT.	PRICE
44006	Lens (CL-1)	1 oz.	\$.45
44008	Rubber Band (CSB-1)	1 oz.	3 for \$.10
44010	Plastic Nose Cone Window (CW-1)	1 oz.	\$.85
44012	Empty Film Holder Assembly (FH-1)	3 oz.	\$.50
44044	Shutter Guide (CRB-1A)	1 oz.	\$.25
44046	Body Section (CRB-1B)	2 oz.	\$.50
44048	Shutter (CRB-1C)	1 oz.	\$.20
44050	Yellow Adhesive Tape Strips (CTS-1)	1 oz.	\$.25
44052	Nose Cone (PNC-60T)	2 oz.	\$.45
44054	Foam Padding (PSP-2)	1 oz.	\$.25
44056	Adapter (TA-5060C)	2 oz.	\$.50
85316	Metal Slide (FHS-1)	2 oz.	\$.25

CINEROC (CM-8)



CAT. NO.	NAME	SHIP. WT.	PRICE
44122	Pulley	2 oz.	.25
1480	Chassis Parts	6 oz.	2.25
1481	Shutter Gear Advance Claw	Available only as a complete set.	3 oz. .50
44125	Lens		.50
44126	Punched Black Butyrate Tube	5 oz.	.75
1482	Nose Cone Adapter	Available only as a complete set.	6 oz. 1.75
1483	Empty Film Pak	Includes: Film Pak Lid, Film Pak Lid and Plate Pak Film Core, Assembly and Disassembly Pak.	5 oz. .85
44100	Switch		4 oz. .75
44105	Rubber Band		1 oz. .10
44103	Battery Holder		5 oz. 1.50
44107	Motor with Pinion Gear		6 oz. 1.50
44110	First Surface Mirror		1 oz. 2.00
44111	Cineroc Decal		1 oz. .25
44112	Yellow Adhesive Tape Strips		1 oz. .25

NOTE: For additional cold propellant accessories see Estes Model Rocketry Catalogs No. 732 page 49 or No. 741 page 48.

NOTE: For additional information on aerial camera parts write Estes Industries, Customer Service Department, Penrose, Colorado 81240.

BALSA NOSE CONES

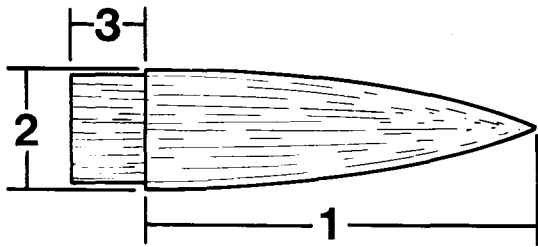

Nose cone dimensions listed in columns 1, 2, and 3.

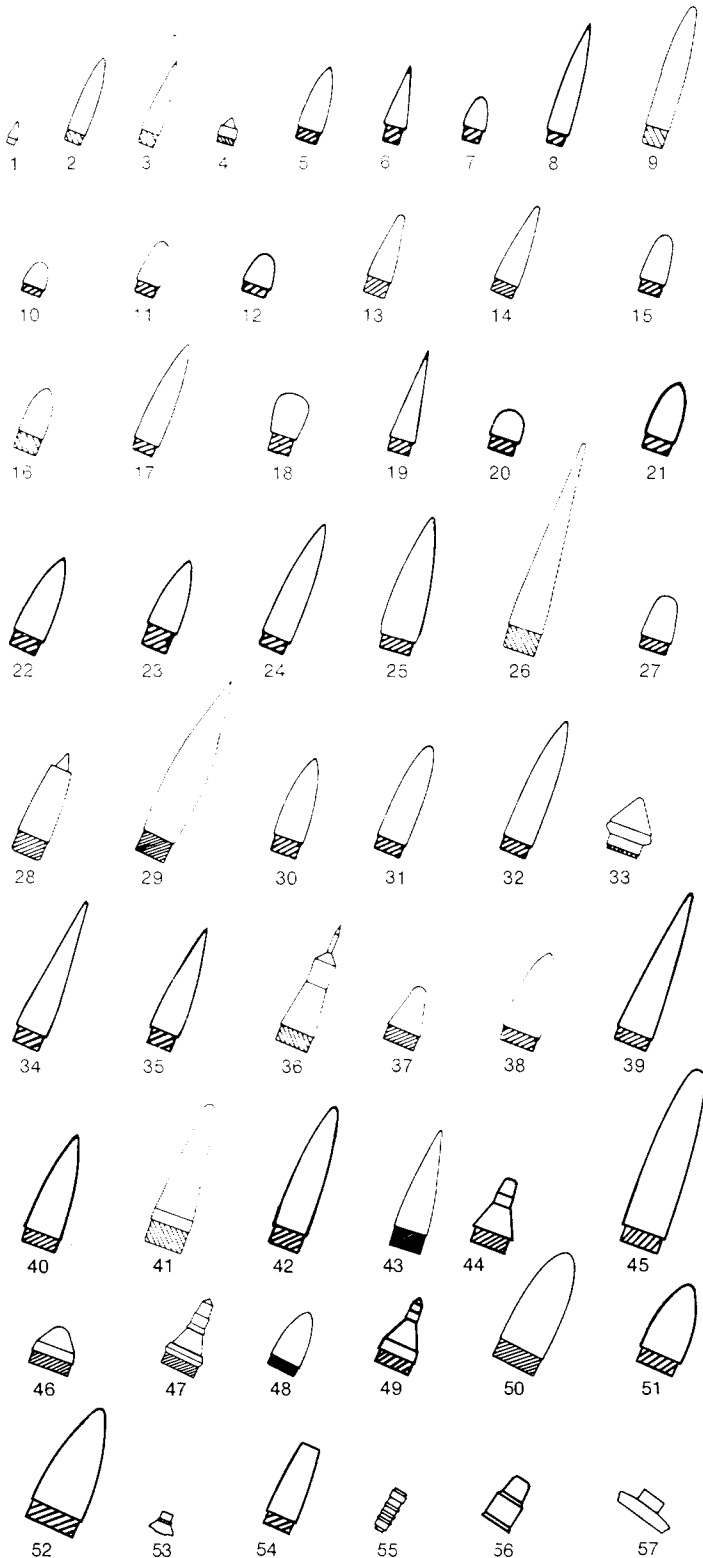

NO.	CAT. NO.	NAME	PRICE EACH	DIMENSIONS			AVG. WT.	SHIP WT.
				1	2	3		
FITS BT-3								
1	70204	BNC-3A	\$.10	3/4"	0.375"	1/4"	0.021 oz.	1oz.
FITS BT-5								
2	70206	BNC-5AW	\$.35	2 1/4"	0.541"	1/4"	0.031 oz.	1oz.
3	70208	BNC-5AX	\$.40	2 1/4"	0.541"	1/2"	0.019 oz.	1oz.
4	70210	BNC-5BA	\$.20	3/8"	0.541"	3/16"	0.013 oz.	1oz.
5	70212	BNC-5E	\$.25	1 3/8"	0.541"	1/4"	0.020 oz.	1oz.
6	70214	BNC-5S	\$.25	1 1/2"	0.541"	1/4"	0.016 oz.	1oz.
7	70216	BNC-5V	\$.25	3/4"	0.541"	1/4"	0.013 oz.	1oz.
8	70218	BNC-5W	\$.40	2 7/8"	0.541"	1/4"	0.039 oz.	2oz.
WING POD Balsa								
9	70500	BWP-EJ	\$.30	2 3/4"	0.541"	0.372"	0.035 oz.	1oz.
FITS BT-10								
10	70220	BNC-10A	\$.20	1 3/16"	0.728"	1/4"	0.03 oz.	1oz.
11	70222	BNC-10B	\$.30	1-11/16"	0.728"	5/16"	0.05 oz.	1oz.
FITS BT-20								
12	70224	BNC-20A	\$.25	1 3/16"	0.736"	1/4"	0.03 oz.	1oz.
13	70226	BNC-20AM	\$.45	2"	0.736"	1/16"	0.033 oz.	1oz.
14	70228	BNC-20AZ	\$.50	2 1/2"	0.736"	1/2"	0.035 oz.	1oz.
15	70230	BNC-20B	\$.30	1-11/16"	0.736"	5/16"	0.05 oz.	1oz.
16	70234	BNC-20L	\$.30	1 3/8"	0.736"	1/2"	0.03 oz.	1oz.
17	70236	BNC-20N	\$.45	2 3/4"	0.736"	1/2"	0.08 oz.	2oz.
18	70238	BNC-20P	\$.40	1-5/16"	0.900"	7/16"	0.07 oz.	4oz.
19	70240	BNC-20R	\$.40	2 3/4"	0.736"	3/8"	0.07 oz.	2oz.
FITS BT-30								
20	70242	BNC-30C	\$.30	3/4"	0.767"	3/8"	0.04 oz.	1oz.
21	70244	BNC-30D	\$.35	1 1/2"	0.767"	3/8"	0.06 oz.	1oz.
22	70246	BNC-30E	\$.45	2-3/16"	0.767"	7/16"	0.07 oz.	1oz.
23	70248	BNC-30M	\$.40	1 1/2"	0.767"	1/2"	0.06 oz.	1oz.
24	70250	BNC-30N	\$.50	2 3/4"	0.767"	1/2"	0.08 oz.	2oz.
FITS BT-50								
25	70252	BNC-50AD	\$.75	4-1/16"	1.300"	1/2"	0.25 oz.	6oz.
26	70254	BNC-50AR	\$.95	5 1/2"	0.976"	3/4"	0.375 oz.	6oz.
27	70256	BNC-50J	\$.40	1 3/8"	0.976"	1/2"	0.08 oz.	4oz.
28	70258	BNC-50BC	\$.80	2 3/4"	0.976"	1/2"	0.156 oz.	4oz.
29	70260	BNC-50BD	\$.85	5"	0.976"	1/2"	0.523 oz.	6oz.
30	70262	BNC-50K	\$.50	2 3/4"	0.976"	1/2"	0.13 oz.	4oz.
31	70264	BNC-50X	\$.65	3 1/4"	0.976"	1/2"	0.15 oz.	4oz.
32	70266	BNC-50Y	\$.80	4 3/8"	0.976"	3/8"	0.16 oz.	6oz.
33	70200	BNC-2	\$.40	1"	1.360"	1/2"	0.19 oz.	4oz.
34	70401	Sergeant (7047)	\$.80	4 1/2"	1.000"	3/4"	0.252 oz.	4oz.
35	70402	Sandpiper (7048)	\$.70	3 1/2"	1.000"	3/4"	0.186 oz.	4oz.
FITS BT-52								
36	70268	BNC-52AG	\$.65	3 1/4"	1.014"	1/2"	0.106 oz.	4oz.
37	70270	BNC-52G	\$.50	1 1/4"	0.988"	1/2"	0.056 oz.	1oz.
FITS BT-55								
38	70272	BNC-55AA	\$.80	3 1/8"	1.325"	1/2"	0.15 oz.	4oz.
39	70274	BNC-55AC	\$.95	5 3/8"	1.325"	3/8"	0.32 oz.	6oz.
40	70278	BNC-55F	\$.85	3 7/8"	1.325"	1/2"	0.19 oz.	4oz.
41	70280	BNC-55AM	\$.95	4"	1.325"	3/4"	0.291 oz.	4oz.
42	70276	BNC-55AO	\$.90	5"	1.325"	3/4"	0.43 oz.	4oz.
43	70282	BNC-55AZ	\$.75	4 3/4"	0.663	3/4"	0.134 oz.	4oz.
FITS BT-60								
44	70284	BNC-60AB	\$.80	2 5/8"	1.637"	3/8"	0.23 oz.	4oz.
45	70286	BNC-60AH	\$ 1.50	7 1/4"	1.637"	7/8"	1.0 oz.	6oz.
46	70288	BNC-60AL	\$.55	1 1/4"	1.680"	1/2"	0.268 oz.	4oz.
47	70290	BNC-60AK	\$.75	3"	1.637"	1/2"	0.308 oz.	4oz.
48	70292	BNC-60L	\$.80	3 1/8"	1.637"	5/8"	0.34 oz.	4oz.
49	70294	BNC-60T	\$.80	2 7/8"	1.637"	1/2"	0.17 oz.	4oz.
FITS BT-65								
50	70296	BNC-65AF	\$.95	4"	1.796"	3/4"	0.50 oz.	4oz.
51	70298	BNC-65L	\$.85	3 1/4"	1.796"	1/2"	0.41 oz.	4oz.
FITS BT-70								
52	70300	BNC-70AJ	\$ 1.50	4 1/4"	2.217"	1"	0.85 oz.	6oz.
TAIL CONE FOR BT-3								
53	70530	BTC-3	\$.10	3/4"	0.770"	1/4"	0.024 oz.	1oz.
TAIL CONE FOR BT-55								
54	70532	BTC-55Z	\$ 1.00	3"	1.325"	1/2"	0.25 oz.	4oz.
FOR MERCURY REDSTONE CAPSULE:								
ESCAPE TOWER Balsa NOSE PLUG								
55	70540	BNP-41	\$.20	1.280"	.406"	None	0.070 oz.	1oz.
Balsa NOSE CONE								
56	71030	PSM-1	\$.35	1.228"	.787"	None	0.175 oz.	3oz.
Balsa TAIL CONE								
57	71032	PSM-1	\$.80	.712"	1.820"	None	0.60 oz.	3oz.

CONSTRUCTION SUPPLIES

CAT. NO.	NAME	DESCRIPTION	SHIP. WT.	PRICE
37828	Contact Cement Capsule	Bonds plastic, metal, wood, paper. High strength, fast drying.	3oz.	3 for \$.25
35010	Dummy Engine Casing—Regular	0.690" outside diameter x 2.75" long	2oz.	\$.15
35011	Dummy Engine Casing—Short	0.690" outside diameter x 1.75" long	2oz.	\$.15
35012	Dummy Engine Casing—"D"	0.945" outside diameter x 2.75" long	3oz.	\$.20
35014	Dummy Engine Casing—Mini	0.500" outside diameter x 1.75" long	1oz.	\$.10
45118	Tape Hinges (TH-1)	4 1/2" x 3/4" self-adhesive strips for B/G elevons.	1oz.	2 for \$.15
35306	Plastic Fin Rail (7020)	6" long for 1/16" balsa	1oz.	\$.15
35307	Plastic Fin Rail (7021)	12" long for 1/16" balsa	2oz.	\$.20
37601	Body Tube Marking Guide (MG-554)	4 Fins for BT-55	1oz.	\$.20
37602	Body Tube Marking Guide (MG-503)	3 Fins for BT-50	1oz.	\$.20
37603	Body Tube Marking Guide (MG-553)	3 Fins for BT-55	1oz.	\$.20
37604	Body Tube Marking Guide (MG-604)	4 Fins for BT-60	1oz.	\$.20
84465	Fin Pattern Sheet (PP-2)	14 patterns printed on heavy index stock. All fin designs are flight proven.	1oz.	\$.25
84466	Fin Pattern Sheet (PP-3)	15 patterns printed on heavy index stock. All fin designs are flight proven.	1oz.	\$.25
2687	Retractable Blade Knife (KNS-2)	Heavy duty No. 2 aluminum handle, 4 3/4" long, with one double ended No. 2D blade. Blade retracts into handle for safe carrying. Excellent tool for model building.	4oz.	\$ 1.60
2688	Utility Knife (KNS-3)	3 position blade is reversible, retractable, and replaceable.	3oz.	\$.29
900133	Flight Data-Plan Sheets (DS-2)	11" x 17" sheet. Record flight data on one side and design on the other. 1/4" grid.	3oz.	12 for \$.70
900134	Flight Data Sheets	8 1/2" x 11". Each sheet lists data for 4 flights.	3oz.	24 for \$.70

Contact Cement Capsule



Dummy Engine Casing (Regular)



Dummy Engine Casing (Short)

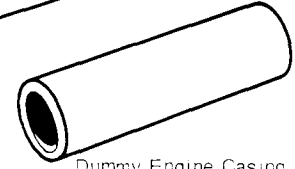

Dummy Engine Casing (D)

Dummy Engine Casing (Mini)

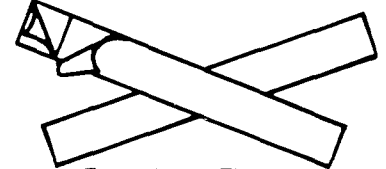
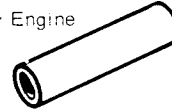

Tape Hinges (TH-1)

Plastic Fin Rail

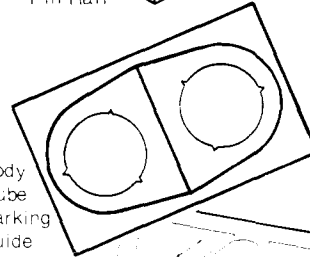
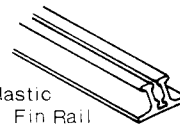

Body Tube Marking Guide

Fin Pattern Sheets

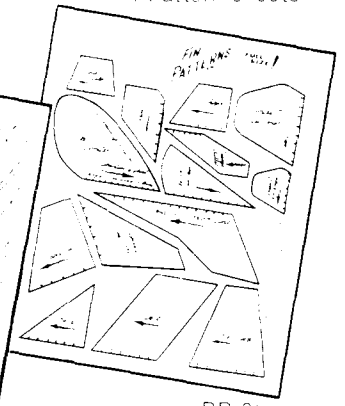

(PP-2)

(PP-3)

Retractable Blade Knife

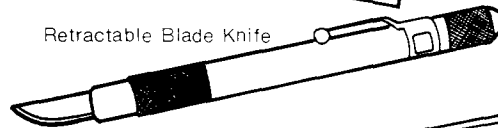

Utility Knife

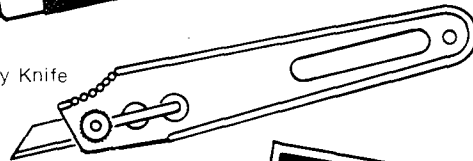

Flight Data-Plan Sheets (DS-2)



Flight Data Sheets

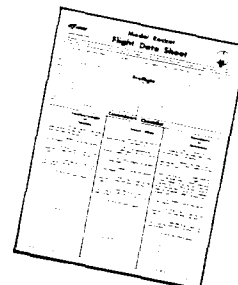

NOTE: For additional information on construction and finishing supplies see Estes Model Rocketry Catalogs No. 732 or 741, pages 59 to 75.

DECALS (WATER TRANSFER)

CAT. NO.	NO.	NAME	PRICE	COLORS	SIZE
1	37031	Mark 2 (KD-2A)	\$.25	Black on Clear	2 3/4" x 2 11/16"
2	37014	Alpha 3 (D-14)	\$.25	Black on Clear	3 13/16" x 4 1/2"
3	37032	Aerobee 300 (KD-17)	\$.30	Black & White	2" x 4"
4	37033	Arcas (KD-26)	\$.10	Black on Clear	13/16" x 4 9/16"
5	37034	Honest John (KD-27)	\$.40	Black on Clear	2 15/16" x 8 9/16"
6	37035	Thor Agena B (KD-28)	\$.40	Black on Clear	3 1/4" x 10 5/8"
7	37036	Saturn 1B (KD-29)	\$.45	Red, Black & White	4" x 11"
8	37037	Little Joe II (KD-30)	\$.20	Black on Clear	2 1/4" x 7"
9	37038	Saturn V (KD-36)	\$.55	Red, White, Blue & Black	3 5/8" x 8 5/16"
10	37039	Scrambler (KD-37)	\$.40	Black, Yellow & White	3" x 9"
11	37040	Mercury Redstone (KD-41)	\$.65	Red & Black	4 11/16" x 7 3/8"
12	37041	Orbital Transport (KD-42)	\$.60	Red, Black & White	4 1/4" x 11"
13	37042	Mars Lander (KD-43)	\$.75	Red, Blue, Yellow & Black	3 5/8" x 9"
14	37043	Beta (KD-45)	\$.15	Black on Clear	3" x 4 1/2"
15	37044	Shrike (KD-46)	\$.50	Blue & Yellow	2 5/8" x 3"
16	37045	Cherokee (KD-47)	\$.65	Red & Black	4 1/4" x 6"
17	37046	Bandit (KD-48)	\$.65	Black & White	3 7/16" x 6 1/16"
18	37047	Sprint (KD-49)	\$.25	Blue & Yellow	1 5/8" x 3 11/16"
19	37049	Interceptor (KD-50A)	\$.60	Red, White, Blue & Black	4 1/2" x 12 1/2"
20	37050	Interceptor (KD-50B)	\$.50	Yellow, Black & Red	4 1/4" x 9"
21	2480	Omega (KD-52 & KD-52A)	\$1.50	Blue & Black (2 Sheets)	4 1/2" x 12"
22	37053	Saros (KD-54)	\$.30	Black, Red & White	2" x 2 1/2"
23	37054	Goblin (KD-55)	\$.40	Black on Clear	3" x 6"
24	37055	Skydart (KD-57)	\$.40	Blue & Black	3" x 6"
25	37057	Demon (KD-58B)	\$.50	Black & White	4 5/8" x 6 1/8"
26	37202	Red Max (KD-A2)	\$.35	Black & White	5" x 11 1/2"
27	37203	Patriot (KDM-3A)	\$.75	Red, White & Blue	6" x 12"
28	37204	Patriot (KDM-3B)	\$.35	Gold, Black & White	6" x 7 1/2"
29	37205	Starship Vega (KDM-4A)	\$.45	Red, Black & White	5" x 12"
30	37209	Bomarc (KDM-5C)	\$.60	Red, White, Blue & Black	4" x 7 1/2"
31	37301	Screamer (TK-D2)	\$.20	Black on Clear	2 5/8" x 3 7/16"
32	37302	Mini-Bertha (TK-D3)	\$.40	Red & Black	2 3/4" x 4 5/8"
33	37303	Mini-Bomarc (TK-D5)	\$.45	Red, White, Blue & Black	3" x 3 3/4"
34	37316	Wolverine	\$.45	Red & Black	4 1/8" x 5"
35	37317	Aero-Hi	\$.25	Silver, Black & White	2 5/8" x 3 3/16"
36	37318	Rogue	\$.30	Black & White	2 7/16" x 4 5/8"
37	37319	Little John	\$.20	White on Clear	2" x 2 5/8"
38	37330	Star Blazer (KDTK-31)	\$.60	Red, White, Blue & Black	3 9/16" x 6 1/2"
39	37575	Valkyrie	\$.25	Red, White, Blue & Black	3" x 5"
40	37576	Sandpiper	\$.40	Red, White, Blue & Black	2 5/8" x 4 1/2"
41	37577	Sergeant	\$.35	White on Clear	2 5/8" x 4 1/2"
42	37578	X-13	\$.45	Red, White, Blue, Black & Yellow	2 1/8" x 4 7/8"
43	37579	Astro-Gnat	\$.50	Red, White, Blue & Yellow	3 5/8" x 5"
44	37580	Baron	\$.35	Black & Yellow	3 5/8" x 4 7/8"

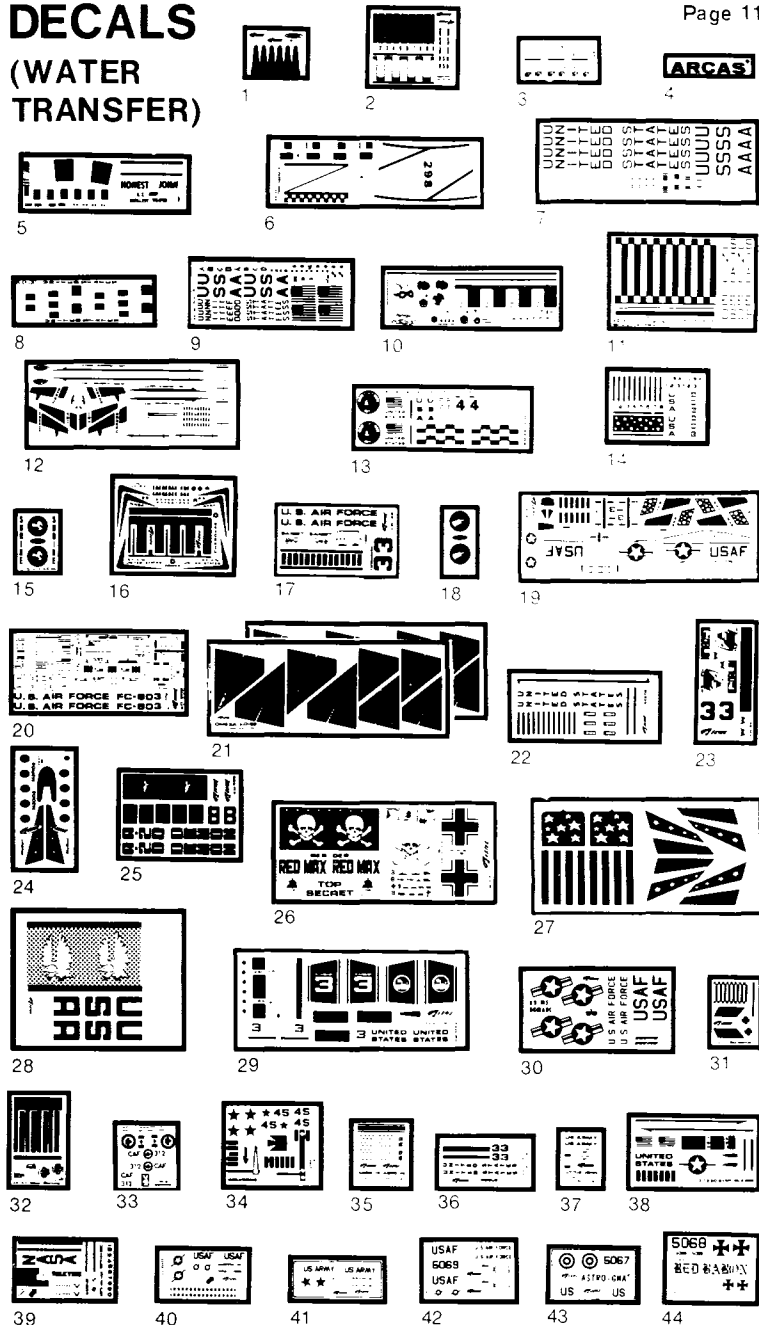

CAT. NO.	NO.	NAME	PRICE	COLORS	SIZE
45	37010	Launch Panel (D-10)	\$.25	Silver & Black Foil	3 1/2" x 5 1/4"
46	37015	Saros (D-54)	\$.25	Silver Foil	2" x 2 1/2"
47	37056	Demon (KD-58A)	\$.60	Silver & Black Foil	4 1/4" x 6"
48	37201	Quasar (KD-M1)	\$.65	Body Wrap Around—Black & Silver	2 1/8" x 8"
49	37206	Starship Vega (KDM-4B)	\$.20	Foil	2" x 3 3/4"
50	37207	Bomarc (KDM-5A)	\$.70	Aluminized Mylar	4" x 12"
51	37208	Bomarc Tape Set	\$.15	4 white strips, 1/4" x 6"	1" x 6"
52	37501	Scamp (KD-L1)	\$.25	Black & White	3 1/16" x 3 1/2"
53	37502	Yankee Five (KD-L2)	\$.29	Red, Black & White	3 5/16" x 6 1/4"
54	37503	Marauder (KD-L3)	\$.29	Black & White	3 5/8" x 4 3/8"
55	37504	Honest John (KD-L4)	\$.29	Yellow, Black & White	3 1/4" x 3 7/8"
56	37505	Teros (KD-L5)	\$.29	Red, Black & White	2 7/8" x 5 3/8"
57	37506	Shark (KD-L6)	\$.29	Red, White, Blue & Black	3 5/8" x 4 7/8"
58	37581	Shrike	\$.29	Orange, Black, Red & White	4" x 8 3/4"
59	37583	Space Shuttle (XS-1)	\$.29	Red, White, Blue & Black	3 5/8" x 5 1/2"

STICK-ON DECALS (SELF-ADHESIVE)

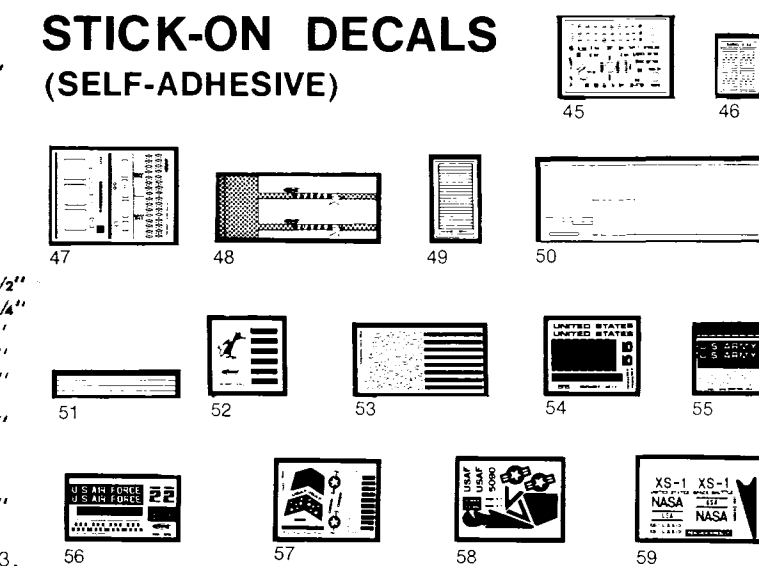

NOTE: Shipping weight for all decals, 2 oz. each. For additional decals see Estes Model Rocketry Catalogs No. 732 or 741 page 73.

DESIGN OF THE MONTH PLANS

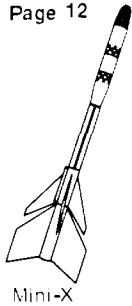

Mini-X

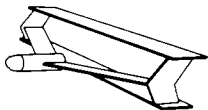

Flying Jenny

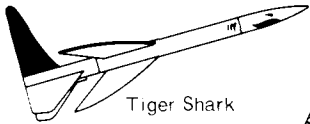

Tiger Shark

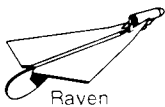

Raven



Clipper

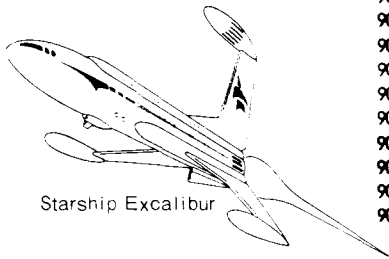

Starship Excalibur

CAT. NO.	NAME	SHIP. WT.	PRICE
900485	Bug-A-Bye Plan No. 4	2 oz.	\$.15
900486	Sputnik-Too Plan No. 15	2 oz.	\$.15
900487	Loadlifter Plan No. 19	2 oz.	\$.15
900397	Mini-X Plan No. 20	2 oz.	\$.15
900488	Flying Jenny Plan No. 21	2 oz.	\$.15
900489	Tiger Shark Plan No. 22	2 oz.	\$.15
900398	Raven Plan No. 23	2 oz.	\$.15
900399	Clipper Plan No. 24	2 oz.	\$.15
900490	Deacon Plan No. 27	2 oz.	\$.15
900401	Augie II Plan No. 28	2 oz.	\$.15
900402	Eagle Plan No. 29	2 oz.	\$.15
900403	Double Trouble Plan No. 30	2 oz.	\$.15
900491	Commuter Plan No. 31	2 oz.	\$.15
900492	Aerobee Hi Plan No. 32	2 oz.	\$.15
900404	Robin Plan No. 33	2 oz.	\$.15
900493	Whee II Plan No. 34	2 oz.	\$.15
900494	Vertex Plan No. 35	2 oz.	\$.15
900495	260 Space Booster Plan No. 36	2 oz.	\$.15
900405	A.S.P. Plan No. 37	2 oz.	\$.15
900496	Gamma Plan No. 38	2 oz.	\$.15
900406	Saturnian Plan No. 39	2 oz.	\$.15
900497	Mitosis Plan No. 40	2 oz.	\$.15
900407	Space Twins Plan No. 41	2 oz.	\$.15
900498	Jaguar JGD-2 Plan No. 52	2 oz.	\$.15
900499	Aero-Fin Plan No. 53	2 oz.	\$.15
900500	Space Freighter Plan No. 54	2 oz.	\$.15
900408	Starship Excalibur Plan No. 55	2 oz.	\$.15
900501	Flyin' Stovepipe Plan No. 56	2 oz.	\$.15
900507	Little Beth X-2 Plan No. 57	2 oz.	\$.15
900409	Zeta Plan No. 58	2 oz.	\$.15
900502	Ganymede 274 Plan No. 59	2 oz.	\$.15
900503	Camroc Carrier Plan No. 60	2 oz.	\$.15
900411	Patna Mark-1 Plan No. 64	2 oz.	\$.15
900412	Scorpion Plan No. 68	2 oz.	\$.15

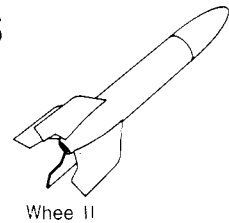

Whee II



A.S.P.

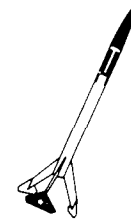

Aero-Fin

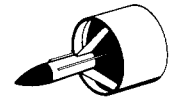

Flyin' Stovepipe



Saturnian

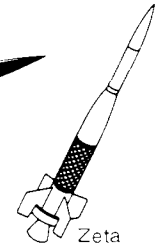

Zeta

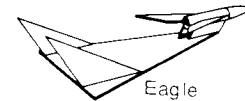

Eagle

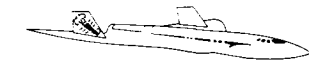

Scorpion

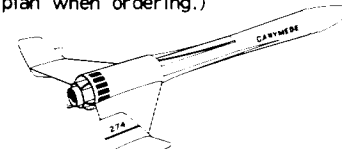

Ganymede

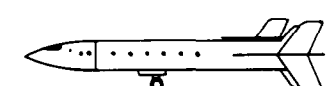



Commuter

SPECIAL OFFER All Plans—2 for \$.25
(Specify catalog number for each plan when ordering.)

Use These Estes Bonus Coupons With Your Custom Parts Orders.
Please Use Only One Coupon Per Order.

BONUS COUPON

FREE

METRIC RULER



Measures:
• English 1/16's
• English Decimal
• Metric Millimeters.

With parts orders of \$4.00 or more.
Limit one Coupon per order.

Offer Expires 7/1/74

BONUS COUPON

FREE

High Visibility 10" Parachute

Pre-assembled.
Ready to use.
(PK-10R)

With parts orders of \$4.00 or more.
Limit one Coupon per order.

Offer Expires 7/1/74

BONUS COUPON

FREE

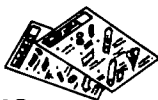

Any 2 DOM Plans

Specify Plan Numbers

With parts orders of \$4.00 or more.
Limit one Coupon per order.

Offer Expires 7/1/74

ENTER THE DESIGN OF THE MONTH COMPETITION AND WIN A \$50.00 MERCHANDISE CERTIFICATE

Have an idea for an original design? Enter our Design of the Month competition today! Simply follow the rules below. Keep those entries coming, and maybe you'll be our next winner.

DOM RULES

- All entries become the property of Estes Industries and cannot be returned.
- Employees of Estes Industries and members of their immediate families are not eligible.
- Any type of model rocketry design can be entered (rockets, boost-gliders, launching or recovery devices, etc.)
- Designs should be new, original, and different, but they also need to be workable. The goal is to develop something new that other rocketeers can build and use successfully, too.
- Entries will be judged on practicality, originality, neatness, completeness, and clarity. Plans do not have to be flight tested and proven.
- Your design entry should include a parts list and any instructions or diagrams you feel would be helpful.
- Please do not send the actual model as it cannot be returned.
- Photos of entries are greatly appreciated, but are not required.
- You may send as many entries as you like.
- New contest every month.
- All designs reaching Estes Industries during the calendar month will be entered in that month's competition. (Date of receipt, not postmark, will determine the month in which a design will be entered.)
- If two or more exceptional entries are received during any month, the judges may, in their discretion, make identical first-place awards or give additional honorable mentions.
- Designs should be sent to the Design of the Month Editor, Estes Industries, Inc., Penrose, Colorado 81240. However, all plans sent to us which are not specifically addressed to another contest or department will be automatically placed in the Design of the Month Competition.
- Each month the designer of the winning entry will receive a certificate entitling them to \$50.00 in merchandise and an award certificate suitable for framing. Award winners will be notified by mail.

GOOD LUCK!!!