

# ICARUS-C

## CONTEST PROVEN FOR NAR PAYLOAD COMPETITION

This model rocket has been designed and developed to give you a straight, high flight if the instructions are followed carefully. The exciting and educational sport of model rocketry has grown into a full scale national activity, and will continue to grow every time you fly your rocket safely. Formation of a rocket club in your area will provide you with hours of enjoyment, even when you're not launching rockets. Look for our new models appearing on your dealer's shelves soon.

**RECOMMENDED ENGINES A3-2, B3-3, C6-4**

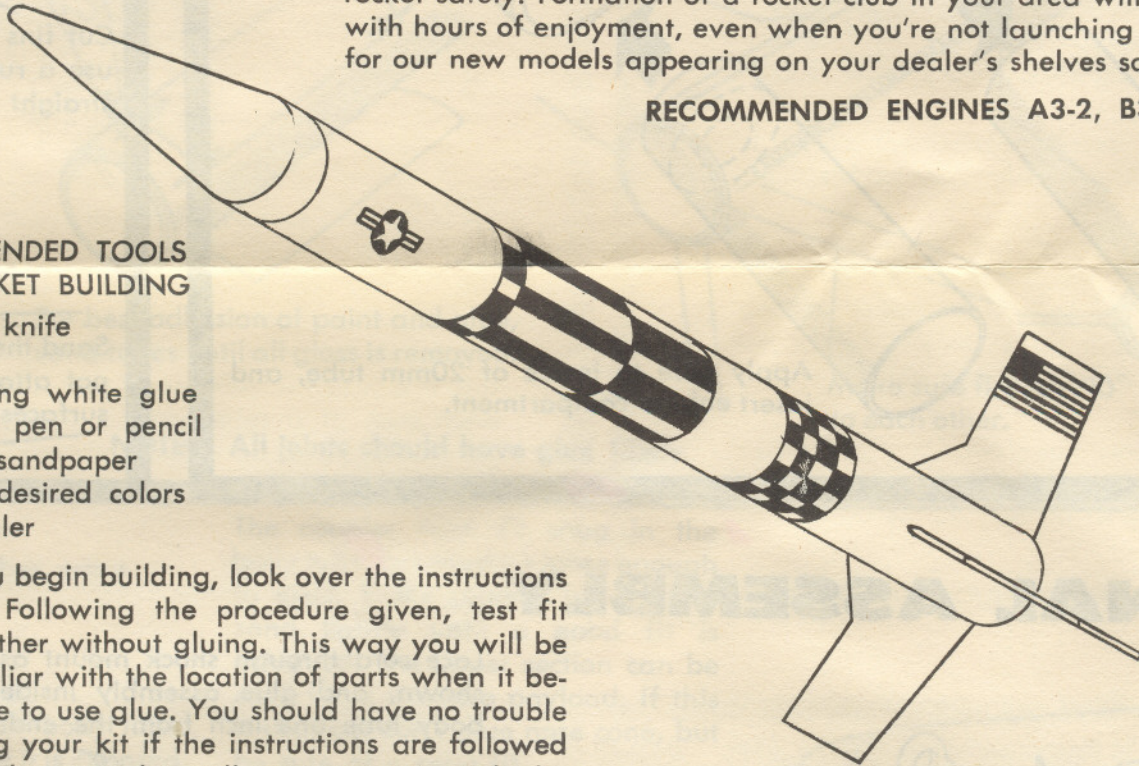

### RECOMMENDED TOOLS FOR ROCKET BUILDING

- Modeling knife
- Scissors
- Extra strong white glue
- Ball point pen or pencil
- Fine grit sandpaper
- Paint, in desired colors
- Wood sealer

Before you begin building, look over the instructions carefully. Following the procedure given, test fit parts together without gluing. This way you will be more familiar with the location of parts when it becomes time to use glue. You should have no trouble assembling your kit if the instructions are followed properly. The parts list will acquaint you with the pieces in the kit. This kit includes a custom fin template. If the use of these fins is desired over the use of the standard fins, follow instructions on template.

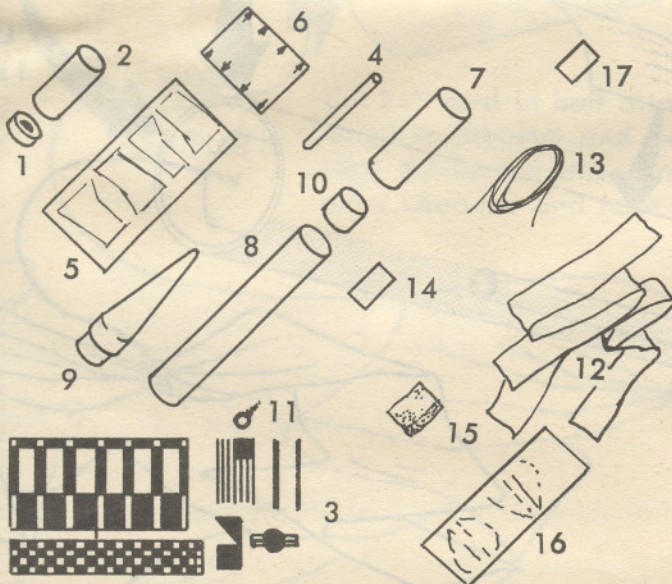

## PARTS LIST

- |                       |                        |
|-----------------------|------------------------|
| 1 ENGINE BLOCK        | 9 NOSE CONE            |
| 2 ENGINE COMPARTMENT  | 10 COUPLER             |
| 3 DECALS              | 11 SCREW EYE           |
| 4 LAUNCHING LUG       | 12 STREAMERS           |
| 5 FIN SHEET           | 13 CORD                |
| 6 FIN GUIDE           | 14 SHOCK MOUNT         |
| 7 BODY TUBE (PAYLOAD) | 15 WADDING             |
| 8 BODY TUBE           | 16 CUSTOM FIN TEMPLATE |
|                       | 17 ADDRESS LABEL       |

# 1 ENGINE COMPARTMENT

Apply glue inside end of engine compartment, and insert engine block until flush with bottom of tube.

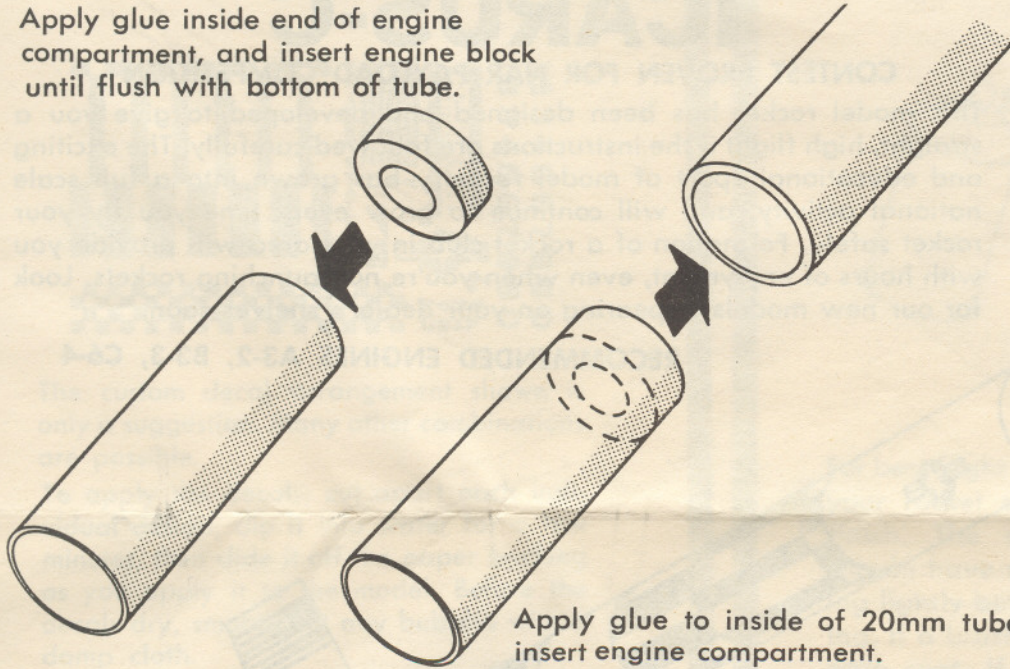

Apply glue to inside of 20mm tube, and insert engine compartment.

# 2 FIN A

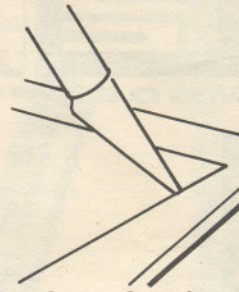

Cut fins from fin sheet use a ruler to help you straight edge.

Sand the three edges of fins so they do not attach to body tube surfaces smooth.

# 3 FINAL ASSEMBLY

Lace cord through shock mount as shown, and glue assembly inside body tube one inch from the end.

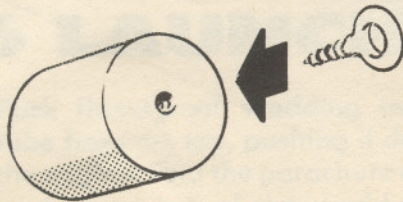

Put screw eye into coupler, then remove it. Put glue in the hole and replace the screw eye.

ADDRESS LABEL

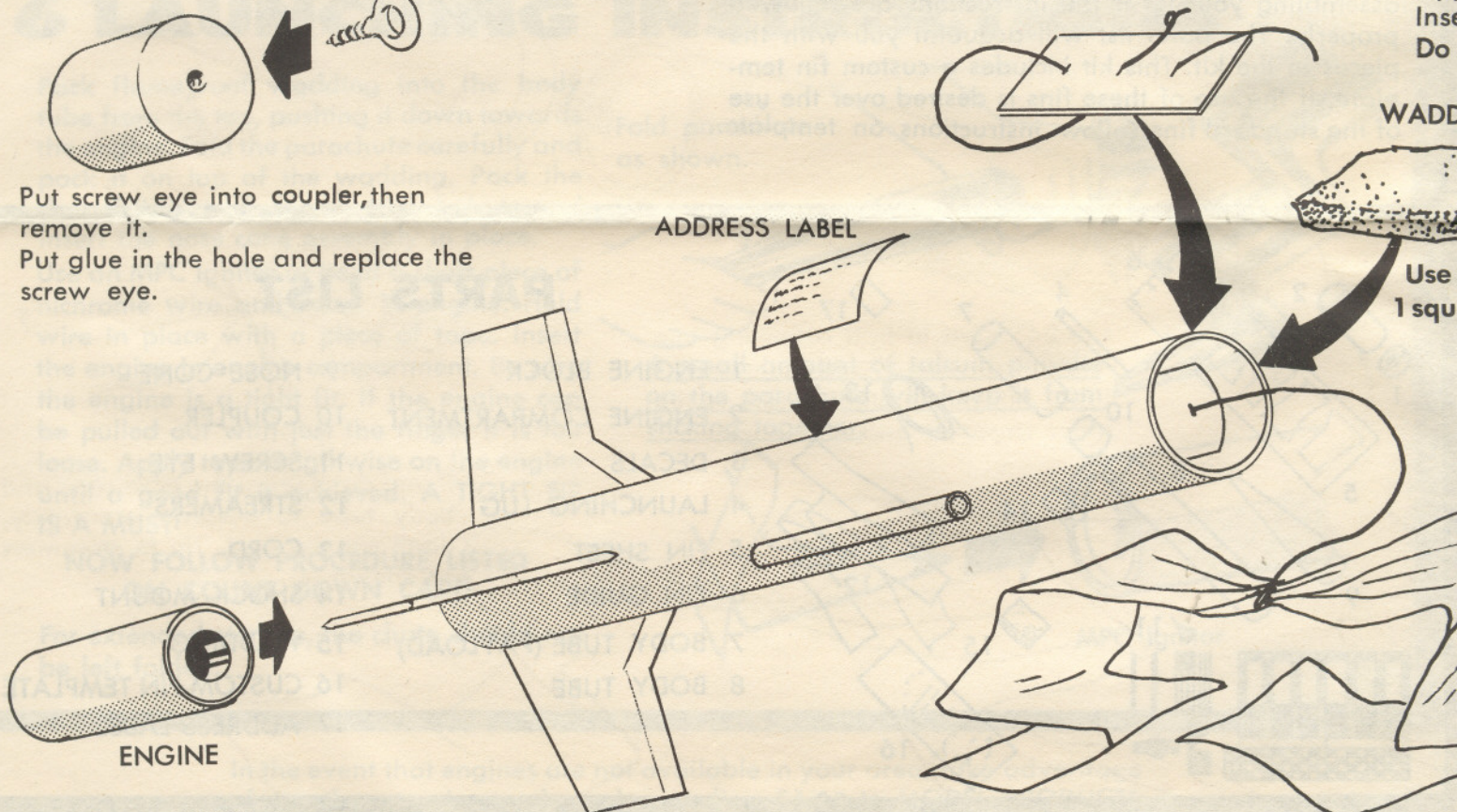

If parts with a

App  
Inse  
Do

WADD

Use  
1 squ

**NOTE:** Engine should not be put in rocket until you are ready to launch.

# ASSEMBLY

Wrap fin guide around body tube where fins will be attached. Mark the body tube near the arrow tips. Remove the fin guide and connect these marks with a straight line to show attaching points.

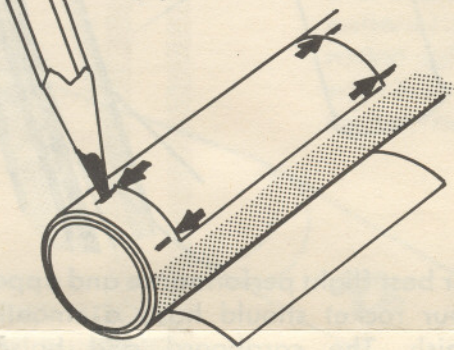

For best adhesion of paint and glue, sand tubes until all gloss is removed.

The bottom of the launching lug should be  $4\frac{1}{4}$ " from bottom of rocket.

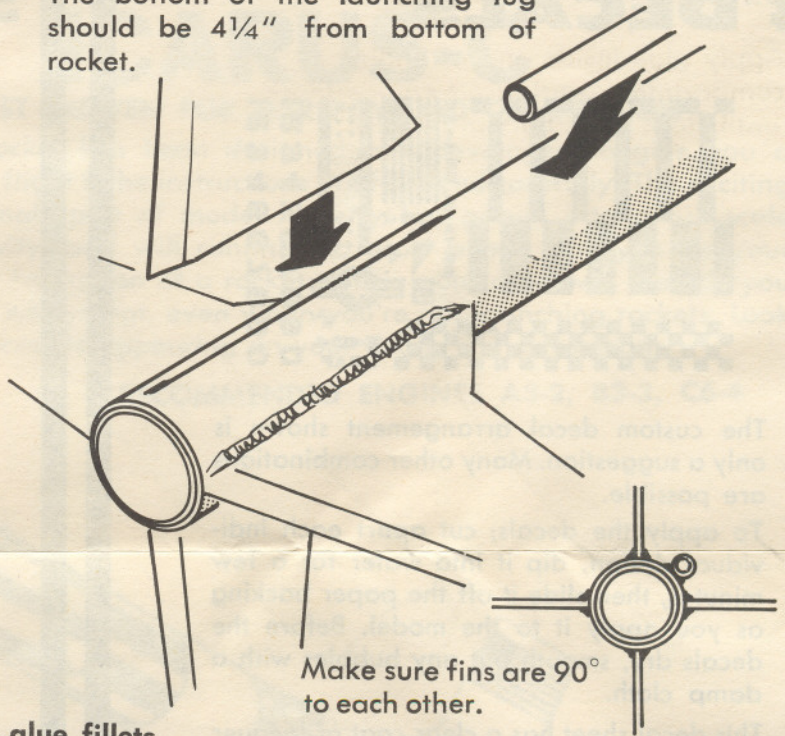

Make sure fins are  $90^\circ$  to each other.

**NOTE:** All joints should have glue fillets.

loose in body tubes, wrap  
piece of tape.

The coupler must fit snug in the body tube, but must be loose enough to eject. If the coupler is too tight sand lightly until a good fit is achieved. The upper section can be used for a 1 ounce payload. If this is desired, don't glue nose cone, but be sure of a snug fit.

glue inside short body tube.  
coupler so half of it is exposed.  
not glue this exposed end.

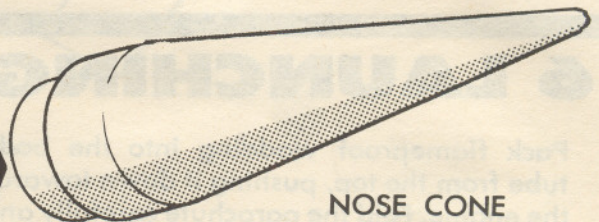

NOSE CONE

NG

approx.  
inch.

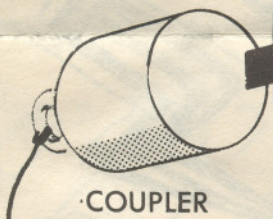

COUPLER

Cut 24" cord in half attaching one length to streamer and main body tube. Attach the other length to the other streamer and nose cone.

If you don't want the nose cone and body tube to descend separately, don't cut the cord. Tie to streamers as shown.

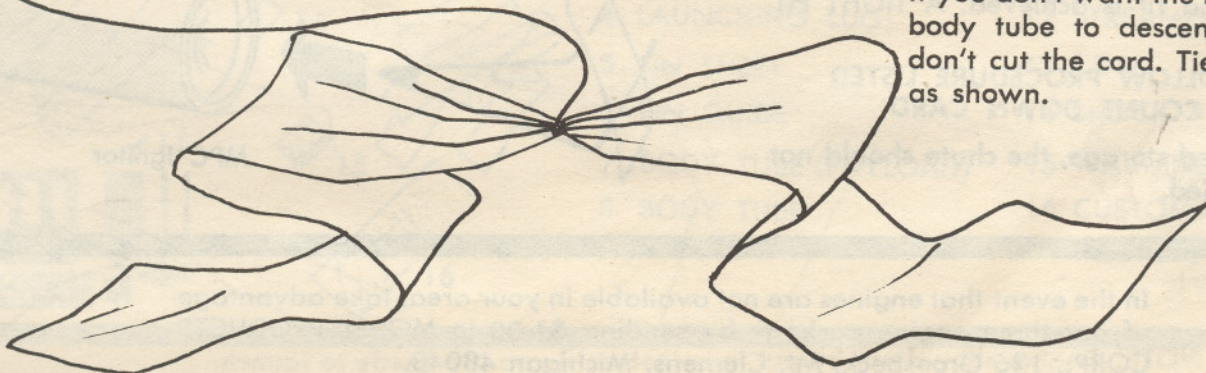
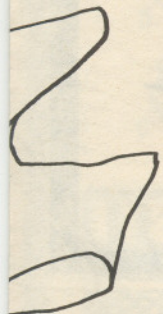
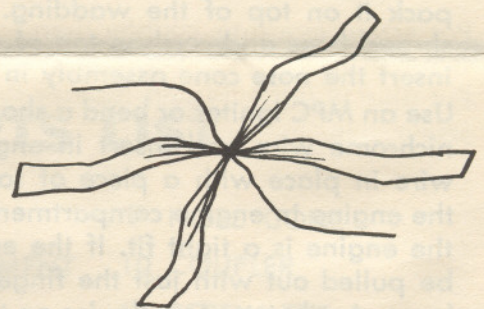

## 4 DECALS

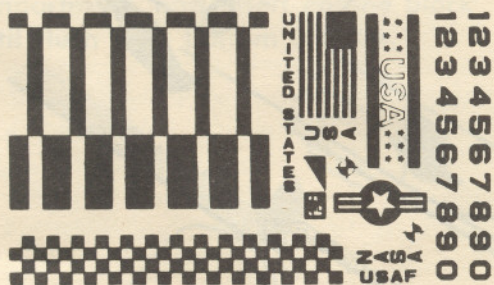

The custom decal arrangement shown is only a suggestion. Many other combinations are possible.

To apply the decals; cut apart each individual design, dip it into water for a few minutes, then slide it off the paper backing as you apply it to the model. Before the decals dry, smooth out any bubbles with a damp cloth.

This decal sheet has a clear coat of lacquer over its entire surface. For best results cut the decal apart as close to the designs as possible.

## 5 PAINTING



For best flight performance and appearance your rocket should have a smooth, hard finish. The cardboard and balsa parts should have several coats of sealer, sanding lightly between each coat. When painting, if a brush is used, sand carefully after each coat. If a spray can is used, apply several light coats avoiding runs. Bright colors are best for easy spotting and recovery.

## 6 LAUNCHING INSTRUCTIONS

Pack flameproof wadding into the body tube from the top, pushing it down towards the engine. Fold the parachute carefully and pack it on top of the wadding. Pack the shroud lines and cord on top of chute and insert the nose cone assembly in place.

Use an MPC Ignitor or bend a short piece of nichrome wire and insert in engine. Hold wire in place with a piece of tape. Insert the engine in engine compartment. Be sure the engine is a tight fit. If the engine can be pulled out with just the finger it is too loose. Apply tape lengthwise on the engine until a good fit is achieved. A TIGHT FIT IS A MUST!

**NOW FOLLOW PROCEDURE LISTED ON COUNT DOWN CARD**

For extended storage, the chute should not be left folded.

Fold parachute as shown.



A small amount of talcum powder on the parachute will keep it from sticking together.

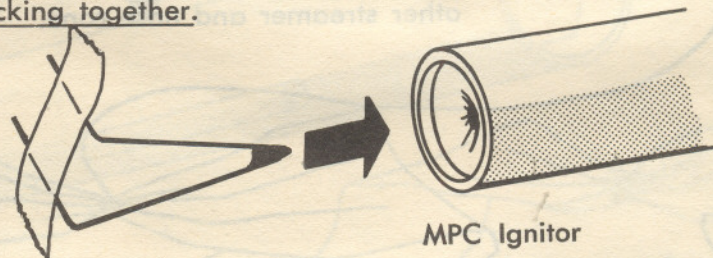

In the event that engines are not available in your area, take advantage of our three engine package by sending \$1.00 to MODEL PRODUCTS CORP., 126 Groesbeck, Mt. Clemens, Michigan 48043.



MODEL PRODUCTS  
126 GROESBECK HIGHWAY  
MT. CLEMENS, MICH. 48043

# CUSTOM FIN TEMPLATE

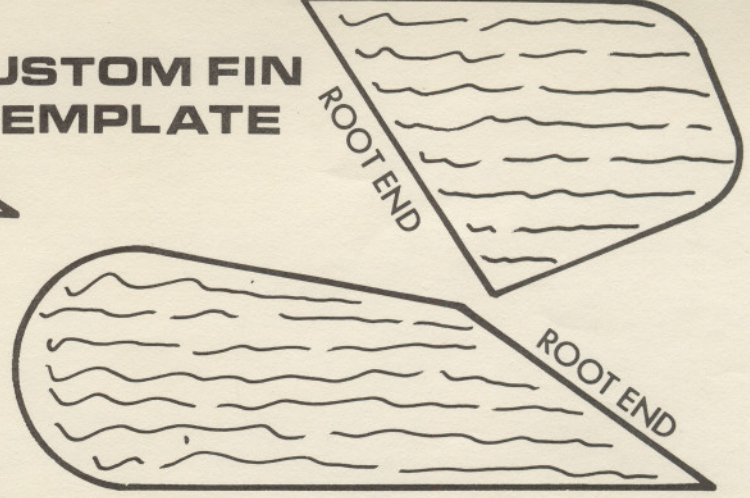
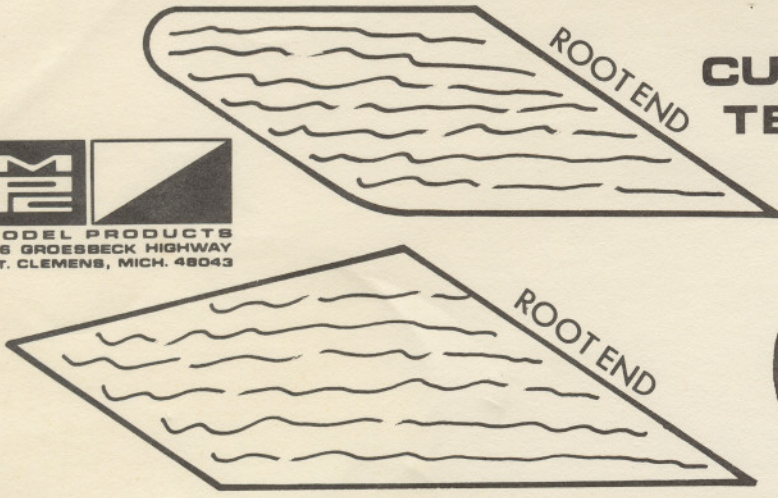

TODAY



Quick Page Finder

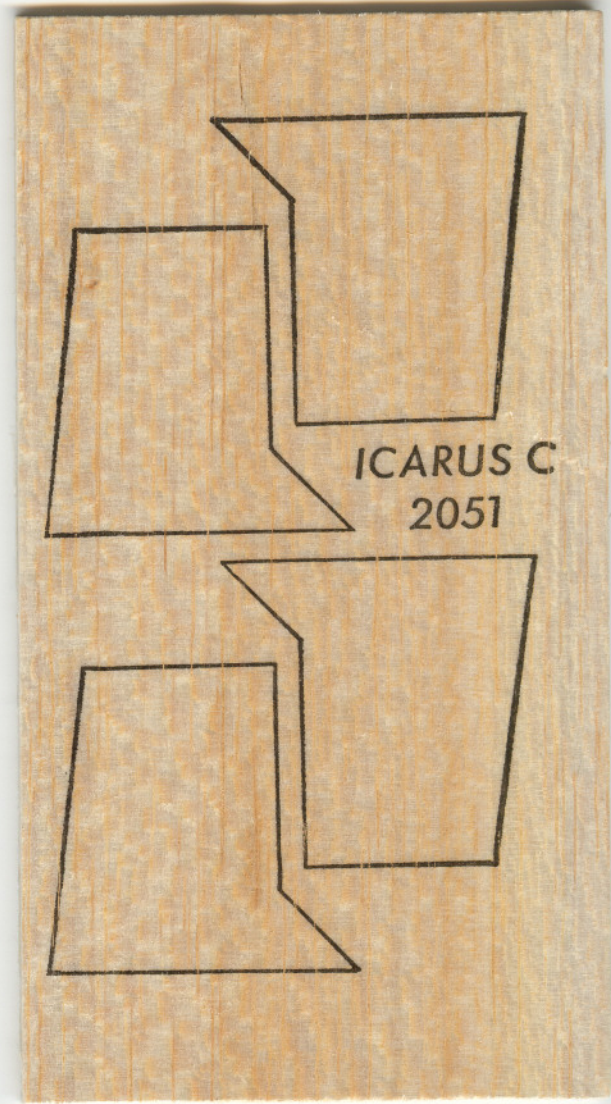

ICARUS C  
2051

TODAY



Quick Page Finder

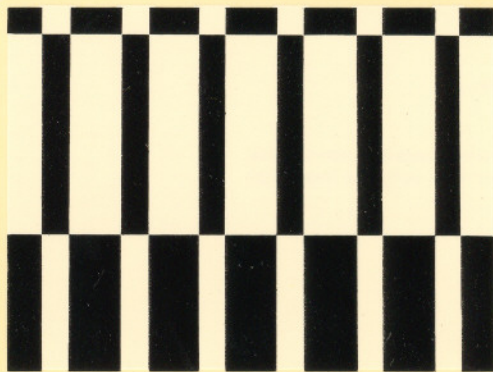

UNITED STATES



USA



NASA  
USAF

1234567890  
1234567890  
1234567890

IF FOUND PLEASE RETURN TO

NAME \_\_\_\_\_

ADDRESS \_\_\_\_\_

PHONE \_\_\_\_\_

1 2 3 4 5 6 7 8 9 0

1 2 3 4 5 6 7 8 9 0



NAVY  
USAF



ASC



UNITED STATES

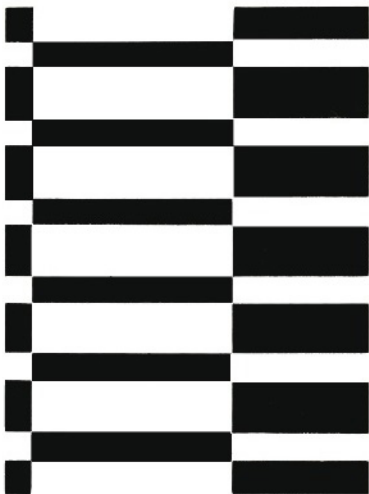

# ICARUS C

FLYING MODEL  
ROCKET KIT

MACH 10 SERIES  
BALSA PARTS  
WITH FIBER-TUBE ROCKET BODY

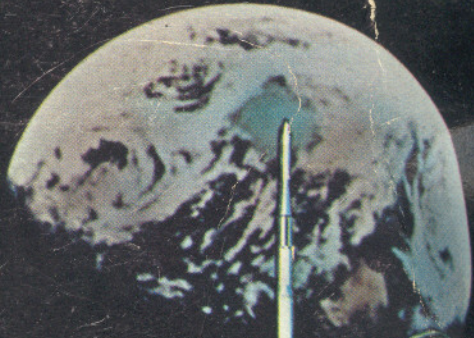
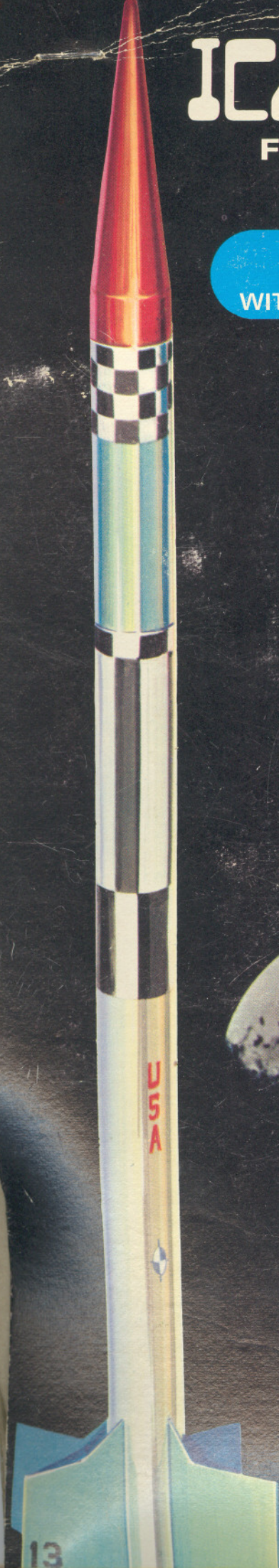

Engines NOT included in kit  
USE ONLY THE FOLLOWING  
MPC ROCKET ENGINES WITH

13



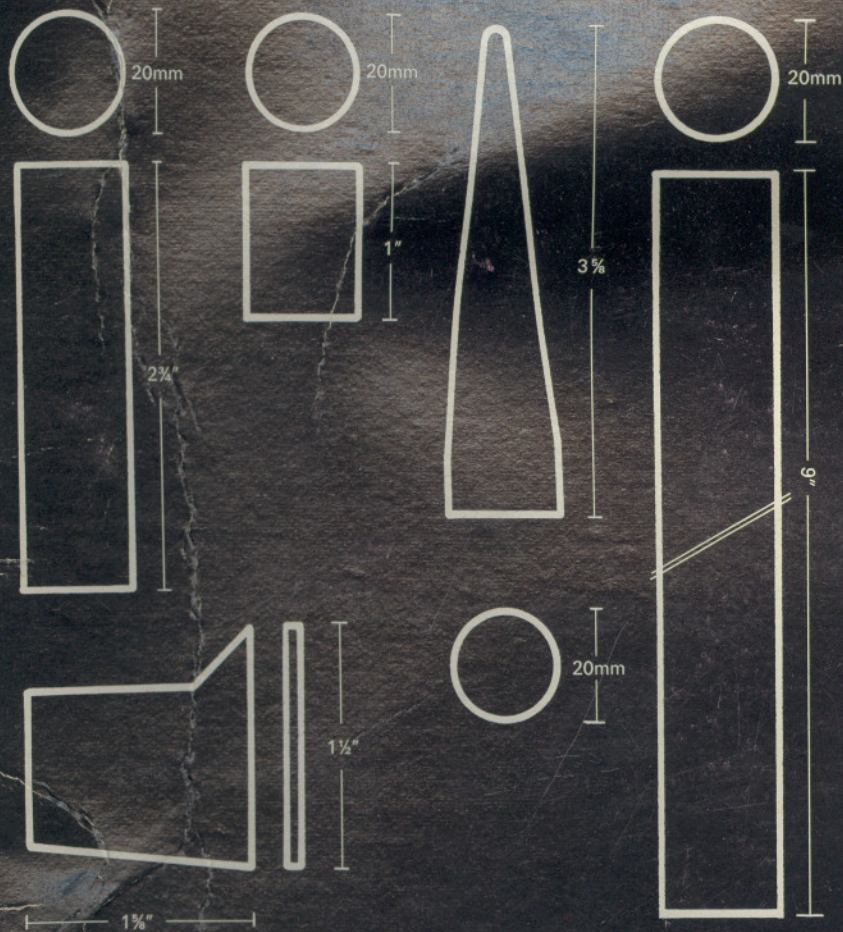

FINISHED MODEL LENGTH 15 INCHES, WT. 1 OZ.

**THE PERFECT DESIGN FOR NAR  
QUADRATHON COMPETITION**

**KIT INCLUDES:** Balsa nose cone • Balsa fin sheet • 2 fiber body tubes • Balsa coupler • 2 streamers • Shock cord • Screw eye • Shock mount • Fiber engine tube • Fiber engine block • Launch lug • Launch lug • Fin guide • Decals • Optional fin plans



Paint to match illustrations available at your dealer.  
Cement not included.

Made and Litho in U.S.A.  
MODEL PRODUCTS CORPORATION • MOUNT CLEMENS, MICHIGAN 48043