

FLYING MODEL

ROCKET™

SKILL LEVEL 1

SPACE TRANSPORT CORPORATION RUBICON

- Mighty D-Engine Power!
- 1:11 Scale
- 18 in. (46 cm) Parachute Recovery!
- Flies 450 ft (137 m) High!

ANSARI

X

PRIZE®

The \$10 Million Race Into Space!

Awarded to the first privately funded team to launch a spaceship capable of carrying three people into outer space, twice within two weeks.

More details about the team and spaceship inside.

Almost
2 Feet
(58.2 cm)
Tall!



Includes a D-Engine™ for
power and a parachute
recovery system. The
rocket is made of
high-quality plastic and
is easy to assemble.
It is a great gift for
anyone who loves
space and flying.



www.estesrockets.com

Space Transport Corporation

RUBICON #2189

ESTES INDUSTRIES
1295 H Street
Penrose, CO 81240
PRINTED IN CHINA

FLYING MODEL ROCKET KIT INSTRUCTIONS
KEEP FOR FUTURE REFERENCE

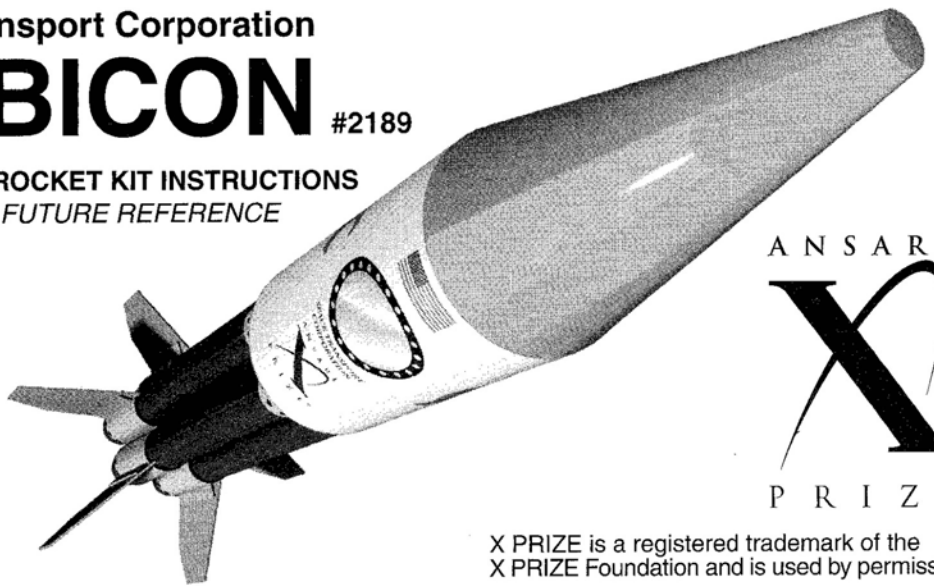

A N S A R I



P R I Z E®

X PRIZE is a registered trademark of the X PRIZE Foundation and is used by permission.

ASSEMBLY TIP: Read all instructions before beginning work on your model. Make sure you have all parts and supplies.

TEST FIT ALL PARTS TOGETHER BEFORE APPLYING ANY GLUE!

If any parts don't fit properly, sand as required for precision assembly.

PARTS

Locate the parts shown below and lay them out on the table in front of you. **DO NOT USE THIS DRAWING TO ASSEMBLE YOUR ROCKET.**

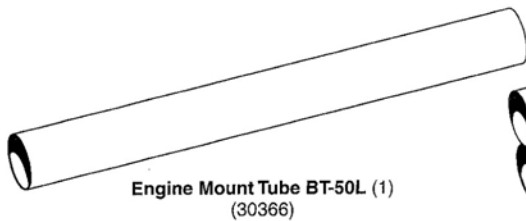

Engine Mount Tube BT-50L (1)
(30366)

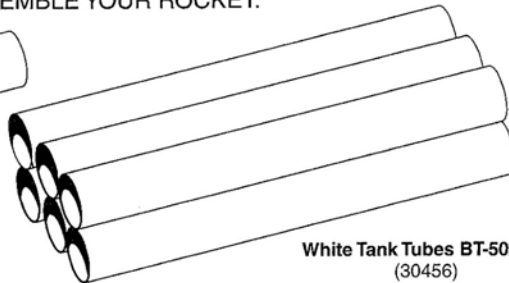

White Tank Tubes BT-50A (6)
(30456)

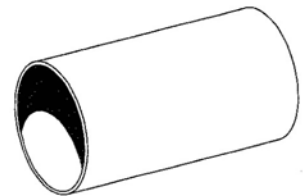

Body Tube BT-321 (1)
(30457)



Engine Hook Retainer Ring (1)
EHR-50 (30160)

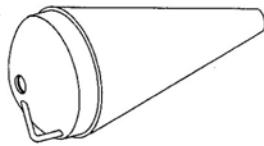

Nose Cone PNC-321 (1)
(60893)



Green Engine Block (1)
AR2050 (30164-2)

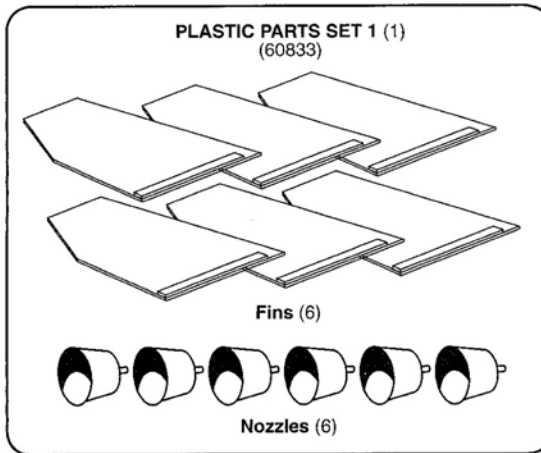

PLASTIC PARTS SET 1 (1)
(60833)

Fins (6)

Nozzles (6)

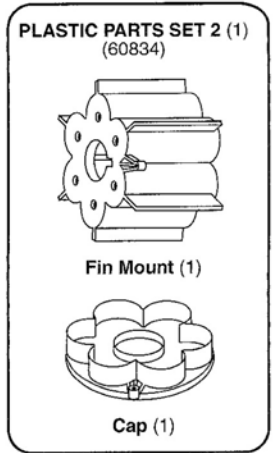

PLASTIC PARTS SET 2 (1)
(60834)

Fin Mount (1)

Cap (1)



Yellow Spacer Tool (1)
(35004)



Engine Hook EH-2 (1)
(35021)



Decal Sheet (1)
(60840)

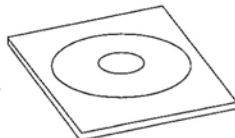

Die Cut Centering Ring (1)
(32437)

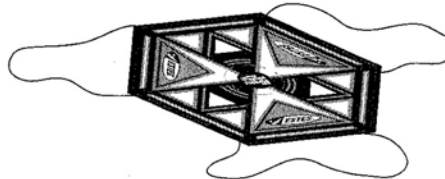

Assembled Parachute 18" (46 cm) (1)
(35802)



Rubber Shock Cord (1/4" x 30")
(1) (38369)

SUPPLIES In addition to the parts included in the kit you will also need:



SCISSORS



PENCIL



RULER



FINE SANDPAPER
(#400-600 GRIT)



CARPENTER'S
GLUE



MODELING
KNIFE



TUBE-TYPE
PLASTIC
CEMENT



MASKING
TAPE



SPRAY
PRIMER
WHITE



SPRAY PAINT:
WHITE, SILVER,
ORANGE, GRAY



SPRAY
CLEAR
COAT

1. ASSEMBLE ENGINE MOUNT

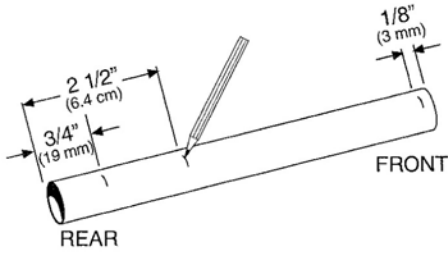

A. Measure and mark Engine Mount Tube.

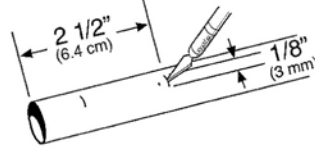

B. Cut 1/8" (3 mm) slit at 2 1/2" (6.4 cm) mark.

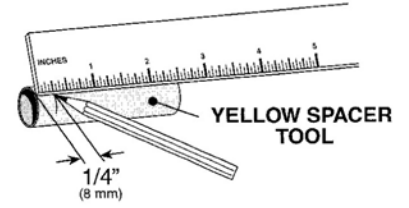

C. Mark Yellow Spacer Tool 1/4" (6 mm) from end.

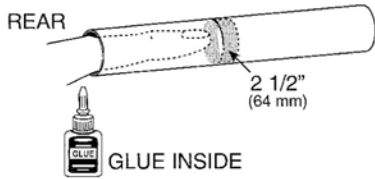

D. Smear glue 2 1/2" (6.4 cm) inside Engine Mount Tube.

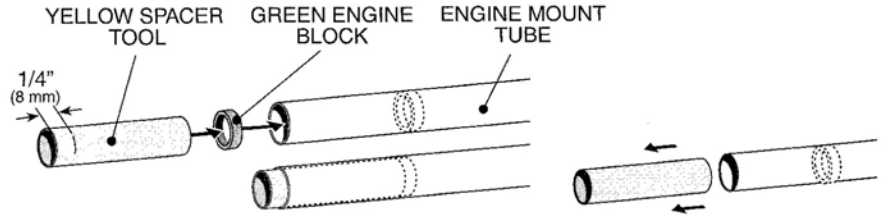

E. Push Engine Block into Engine Mount Tube with Spacer Tool up to mark. Remove Spacer Tool immediately. Let dry.

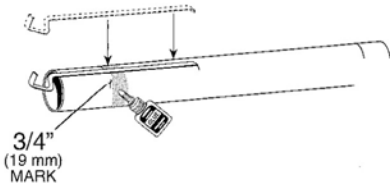

F. Apply glue around tube just ahead of the 3/4" (19 mm) mark. Position Engine Hook. Insert Engine Hook into slit as shown.

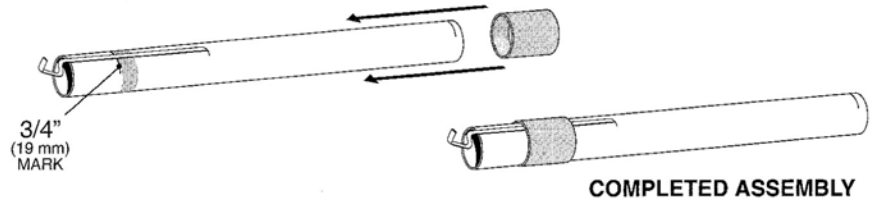

G. Slide Engine Hook Retainer Ring onto Engine Mount Tube up to 3/4" (19 mm) line. Let dry.

2. INSTALL ENGINE MOUNT

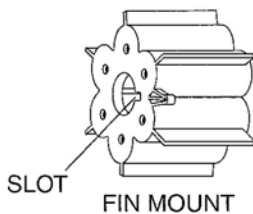

CAUTION: Do Not Apply Glue to Engine Hook.

A. Apply tube type plastic cement to end of of Engine Mount Tube. Align Engine Hook with slot in Fin Mount. Push Engine Mount Tube into place with the end of the tube stopping on the shoulder of the Fin Mount. Let dry completely.

COMPLETED ASSEMBLY

Must be straight →

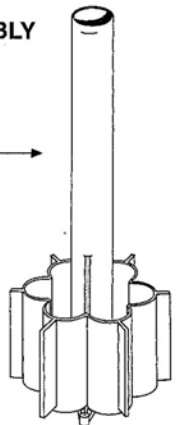

3. INSTALL TANK TUBES, CAP AND RING

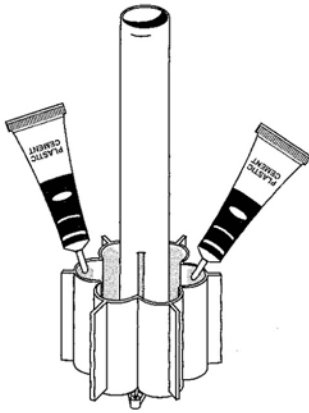

A. Apply tube type plastic cement into each cavity (6).

Note: Support base to avoid Engine Hook interference.

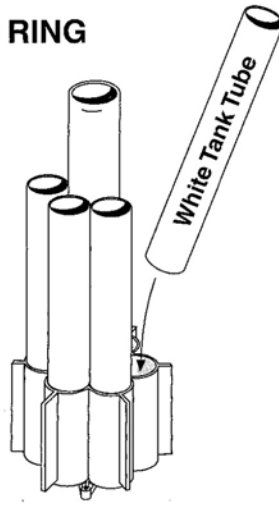

B. Insert one Tank Tube into each cavity. Each tube must touch inside bottom of base. Repeat for remaining five tubes.

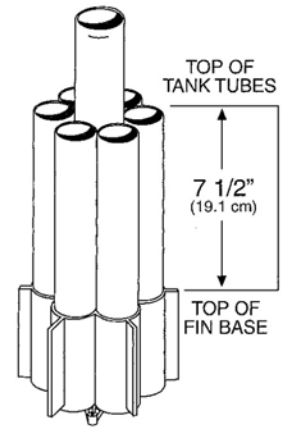

C. All tubes should be even at top.



D. Apply tube type plastic cement to inside of Cap where shown.

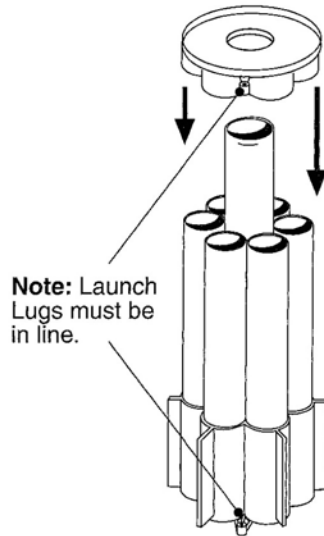

E. Turn Cap over, align Launch Lugs and slide onto Engine Mount Tube. Let dry completely.

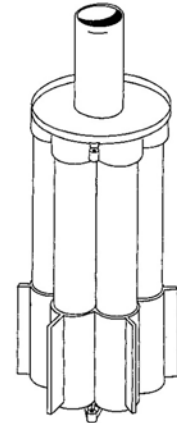

COMPLETED ASSEMBLY

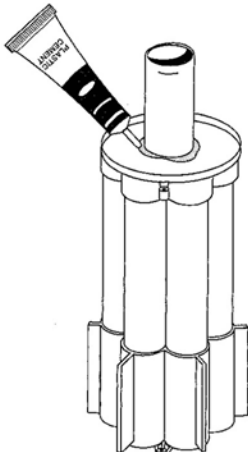

F. Apply tube type plastic cement to Tube/Cap joint. Let dry completely.

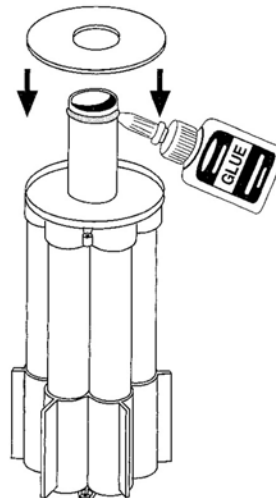

G. Apply Carpenter's glue around tube at the 1/8" (3 mm) mark. Slide Centering Ring onto Tube, even with mark. Let dry completely.

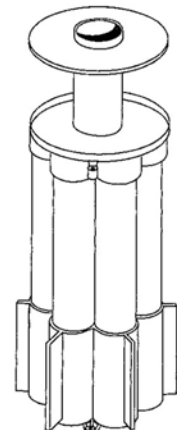

COMPLETED ASSEMBLY

4. INSTALL BODY TUBE

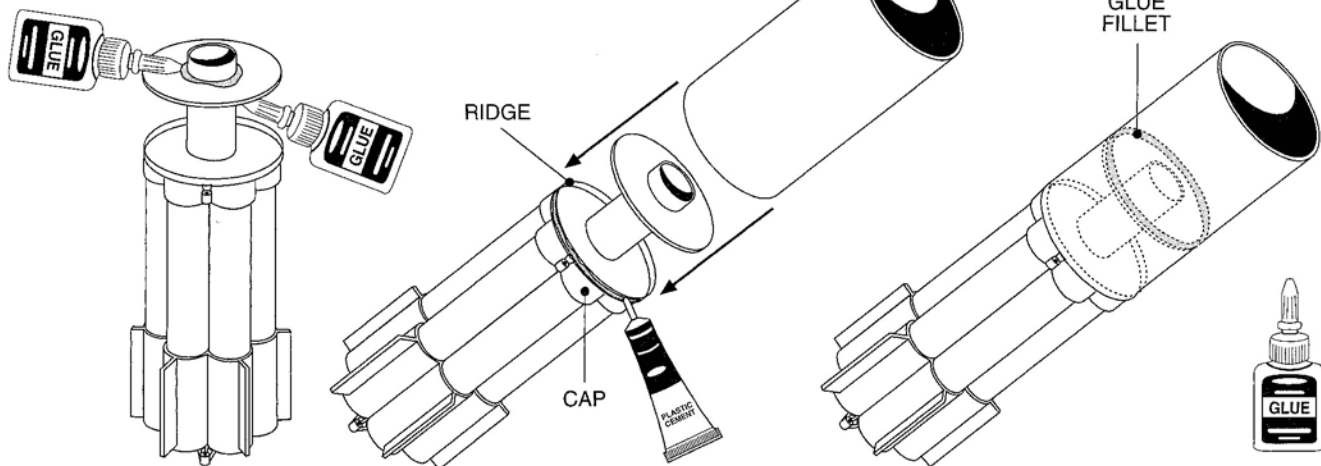

A. Apply a glue fillet around both sides of Centering Ring at Tube/Ring joint. Let dry completely.

B. Apply tube type plastic cement around outside of ridge on Cap. Slide Body Tube down onto Cap. Must be flush. Wipe off any excess glue. Let dry completely.

C. Apply a glue fillet to inside Tube/Ring joint. Let dry completely.

5. ATTACH NOZZLES AND FINS

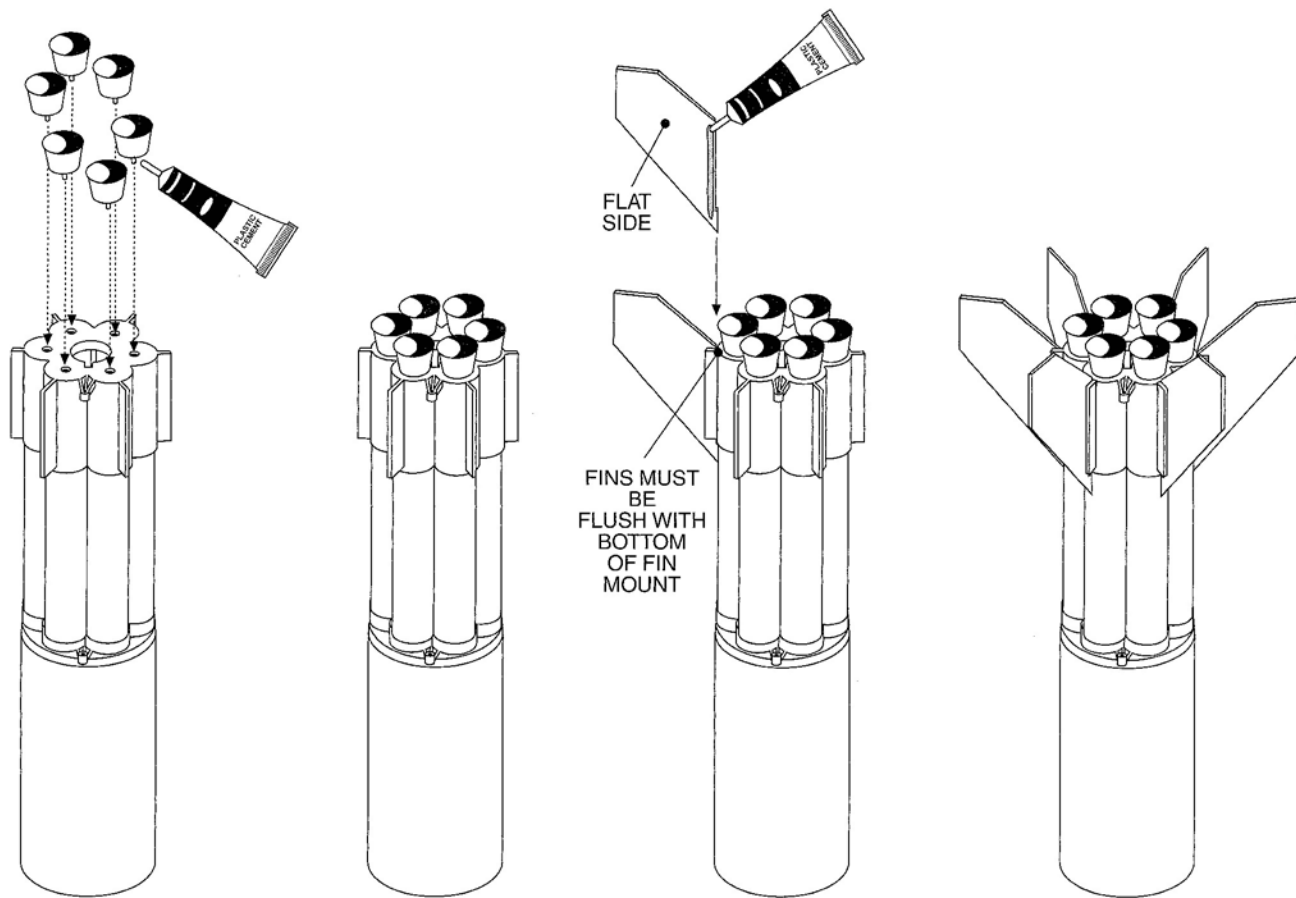

A. Apply tube type plastic cement to narrow ends of Nozzles. Insert into mounting holes in Fin Mount. Let dry completely.

COMPLETED ASSEMBLY

B. Apply tube type plastic cement to flat side of a Fin. Attach to Fin Tab. Fin must be flush with bottom. Let dry completely before proceeding onto remaining fins.

COMPLETED ASSEMBLY

6. INSTALL SHOCK CORD MOUNT

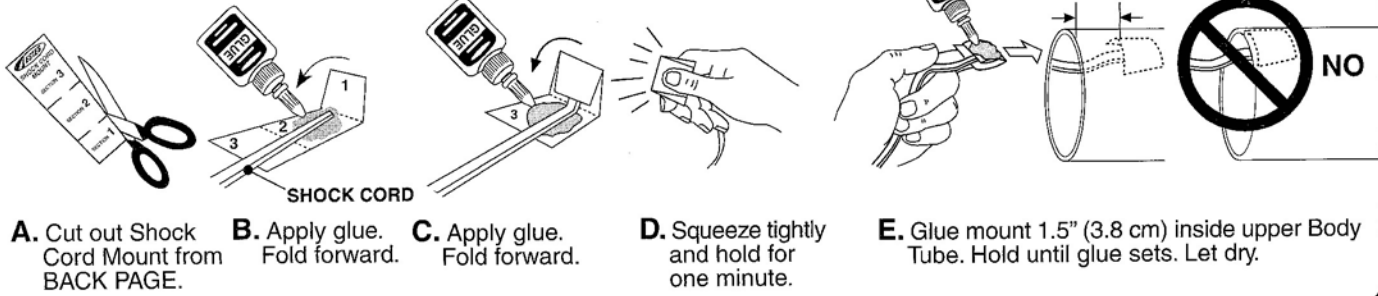

- A.** Cut out Shock Cord Mount from BACK PAGE. **B.** Apply glue. Fold forward. **C.** Apply glue. Fold forward. **D.** Squeeze tightly and hold for one minute. **E.** Glue mount 1.5" (3.8 cm) inside upper Body Tube. Hold until glue sets. Let dry.

7. ATTACH PARACHUTE & SHOCK CORD

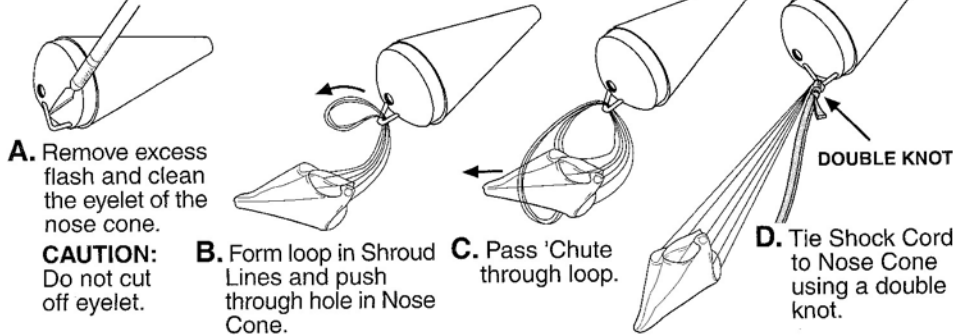

- A.** Remove excess flash and clean the eyelet of the nose cone. **CAUTION:** Do not cut off eyelet. **B.** Form loop in Shroud Lines and push through hole in Nose Cone. **C.** Pass 'Chute through loop. **D.** Tie Shock Cord to Nose Cone using a double knot.

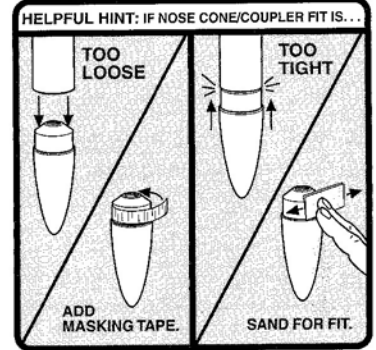

8. FINISHING YOUR ROCKET

First spray rocket with white primer, except for internal tube. Let dry and sand. Repeat until rocket is smooth. FOLLOW THE PAINT SCHEME ON THE PACKAGE.

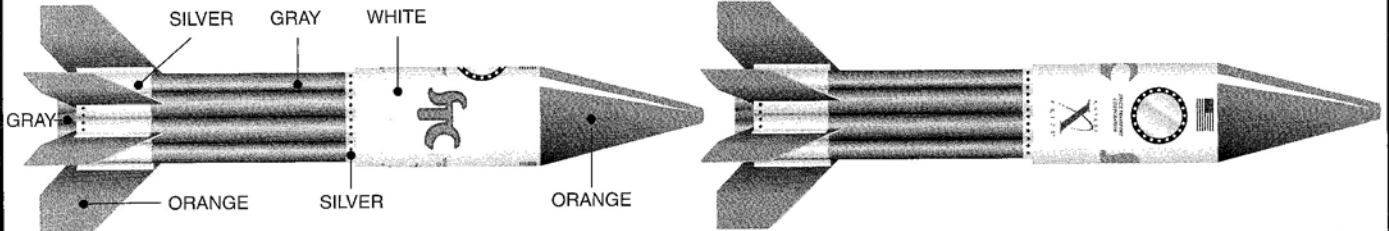

When paint is dry, peel decals one at a time from backing sheet and apply where shown. Rub down to remove bubbles.

OPTIONAL: Spray a clear coat on entire rocket after paint dries and after decal placement.

PREPARE PARACHUTE FOR FLIGHT

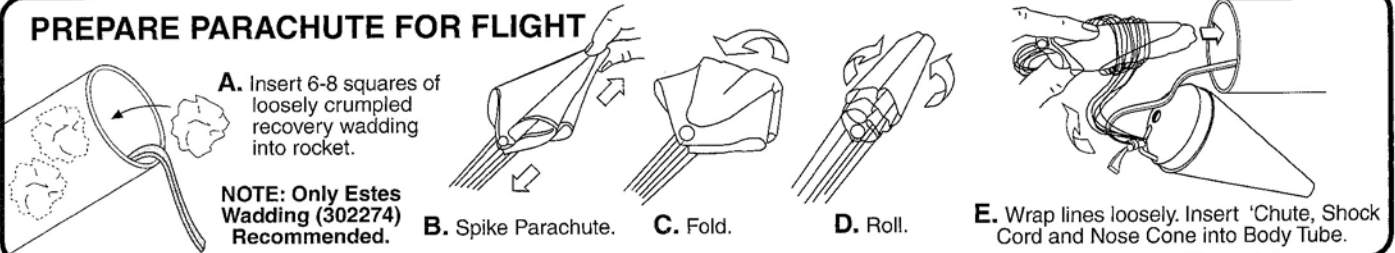

- A.** Insert 6-8 squares of loosely crumpled recovery wadding into rocket.

NOTE: Only Estes Wadding (302274) Recommended.

- B.** Spike Parachute. **C.** Fold. **D.** Roll.

- E.** Wrap lines loosely. Insert 'Chute, Shock Cord and Nose Cone into Body Tube.

PREPARE ENGINE

WARNING: FLAMMABLE

To avoid serious injury, read instructions & NAR Safety Code included with engines.

PREPARE YOUR ENGINE ONLY WHEN YOU ARE OUTSIDE AT THE LAUNCH SITE PREPARING TO LAUNCH!

If you do not use your prepared engine, remove the igniter before storing your engine.

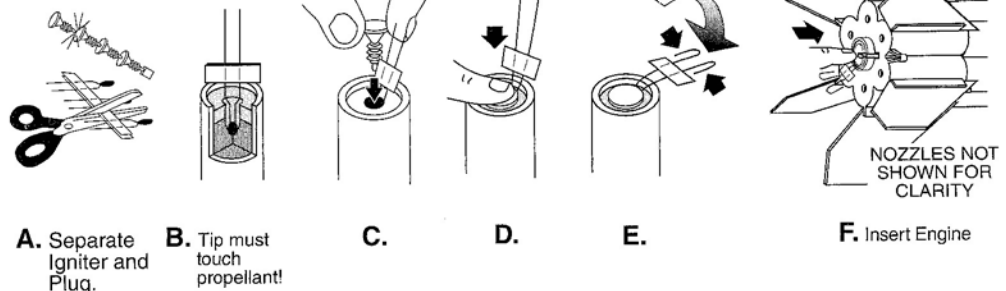

- A.** Separate Igniter and Plug.

- B.** Tip must touch propellant!

C.

D.

E.

- F.** Insert Engine

NOZZLES NOT SHOWN FOR CLARITY

COUNTDOWN AND LAUNCH

SHOCK CORD MOUNT

SECTION 3

SECTION 2

SECTION 1

CUT OUT AND USE FOR STEP 6.

ESTES LAUNCH SUPPLIES

(Sold Separately)

- Porta Pad® II Launch Pad (Requires 3/16" [5 mm] Maxi™ Rod - sold separately).
- Electron Beam® Launch Controller
- Recovery Wadding
- Igniters (with Engines)
- Igniter Plugs (with Engines)
- Recommended Engines: D12-3, D12-5

PRECAUTIONS

NAR Safety Code



NO DRY GRASS OR WEEDS

FLYING YOUR ROCKET

Choose a large field (500 ft. [152 m] square) free of dry weeds and brown grass. The larger the launch area, the better the chance of recovering your rocket. Football fields and playgrounds are great. Launch only with little or no wind and good visibility.

Always follow the National Association of Rocketry (NAR) Safety Code.

MISFIRES

TAKE THE KEY OUT OF THE CONTROLLER. WAIT ONE MINUTE BEFORE GOING NEAR THE ROCKET! Disconnect the igniter clips and remove the engine. Take the plug and igniter out of the engine. If the igniter has burned, it worked but did not ignite the engine because it was not touching the propellant inside the engine. Put a new igniter all the way inside the engine without bending it. Push the plug in place. Repeat the steps under Countdown and Launch.

ANSARI



PRIZE®

TEAM OVERVIEW Space Transport Corporation

One of the newest entrants to the ANSARI X PRIZE race, Space Transport Corporation was founded in August of 2002 by Eric Meier and Philip Storm, former engineers for Aerojet. The company was founded with the vision of maximizing efficiency in development, production, and administration to provide inexpensive space access. The company operates from a 3,500 square foot office/shops in Forks, WA. The community in the beautiful Forks area is founded on a pioneering spirit and STC is proud to be a part of a new generation of pioneers in the region. STC has launched several unmanned sounding rockets, one to a height of 150,000 feet, and has successfully tested the engines that will be used on its manned ANSARI X PRIZE vehicle, the Rubicon.

TEAM SPECIFICATIONS:

Name: Space Transport Corporation. Website: www.space-transport.com
Country of Origin: Forks, Washington, USA

VEHICLE SPECIFICATIONS:

Name: Rubicon
Length: 22 feet (6.7 m). Diameter: 38 inches (96.5 cm). GTOW: 5,000 (2,268 KG).
DRY WT: 1,500 lb (680 KG). Engines: Seven. Total Thrust: 20,000 lb. (88,964 N).
Payload Capacity: 595 lbs (270 kg). Crew Environment: Pressurized cabin.

MISSION SPECIFICATIONS:

Launch Method: Vertical Take-off from ground. Max Accel. Force on Ascent: 7 G's.
Max Speed: 3,000 mph (1,341 m/s). Max. Altitude: ~68 miles (110 km). Time in Weightless Conditions: ~3 minutes. Landing Method: Ocean splashdown via parachute. Total Flight Duration: ~25 minutes.



IMPORTANT!! - INSTRUCTION UPDATE - #2189 RUBICON

Estes Industries
1295 H Street
Penrose, CO 81240

- Step #1 has revised measurements.
- Step #2 and #3 have been modified.

PRINTED IN CHINA

Please follow these steps instead.

1. ASSEMBLE ENGINE MOUNT

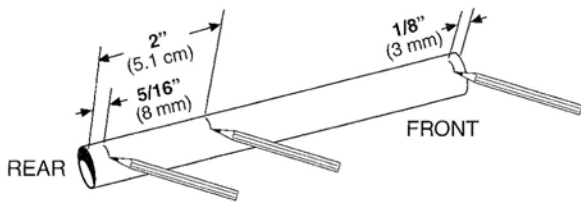

A. Measure and mark Engine Mount Tube.

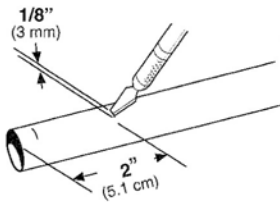

B. Cut 1/8" (3 mm) slit at 2" (5.1 cm) mark.

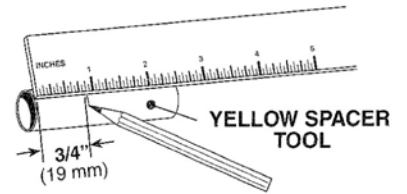

C. Mark Yellow Spacer Tool 3/4" (19 mm) from end.

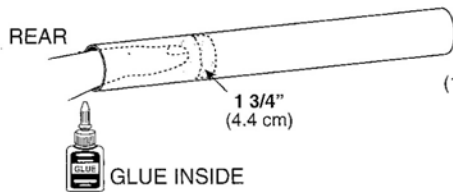

D. Smear glue 1 3/4" (4.4 cm) inside Engine Mount Tube.

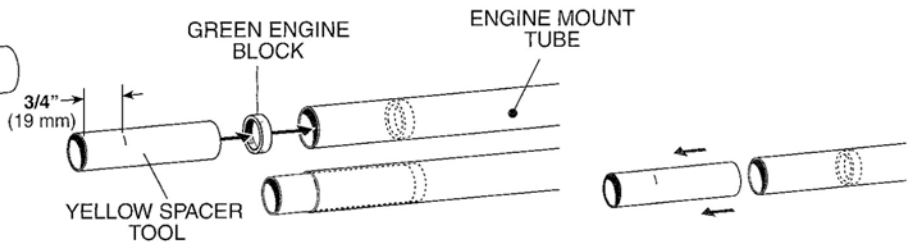

E. Push Engine Block into Engine Mount Tube with Spacer Tool up to mark. Remove Spacer Tool immediately. Let dry.

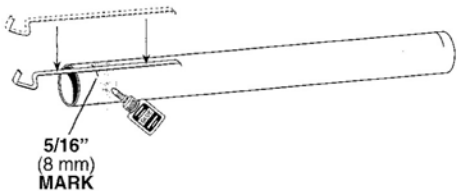

F. Apply glue around tube just ahead of the 5/16" (8 mm) mark. Position Engine Hook. Insert Engine Hook into slit as shown.

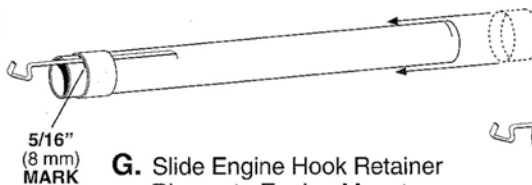

G. Slide Engine Hook Retainer Ring onto Engine Mount Tube up to 5/16" (8 mm) mark. Let dry.



COMPLETED ASSEMBLY

2. INSTALL TANK TUBES

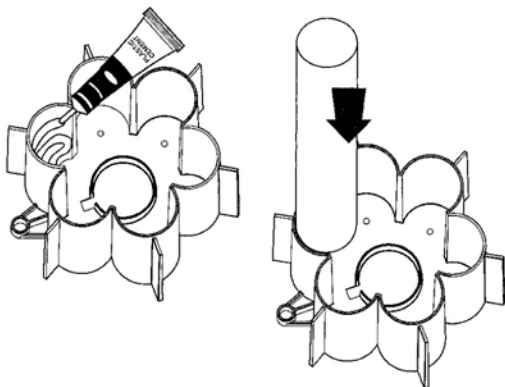

A. Apply tube type plastic cement into one cavity. Insert one Tank Tube into the cavity.

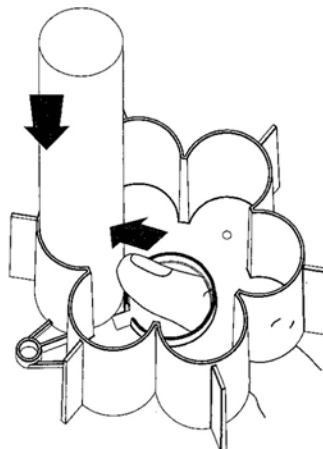

B. Gently press the base of the Tank Tube until it slips down past lip on inside of fin mount, so that bottom of tube rests on bottom of base. Repeat for remaining tubes.

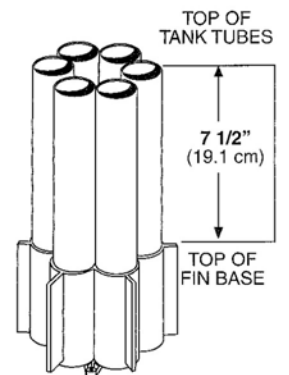

C. All tubes must be even at top.

3. INSTALL ENGINE MOUNT, CAP AND CENTERING RING

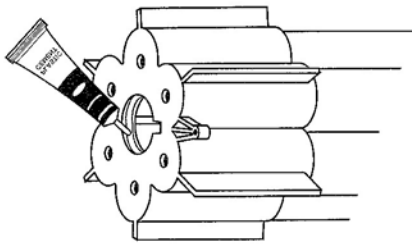

A. Apply tube type plastic cement around inside surface of Fin Mount where shown.

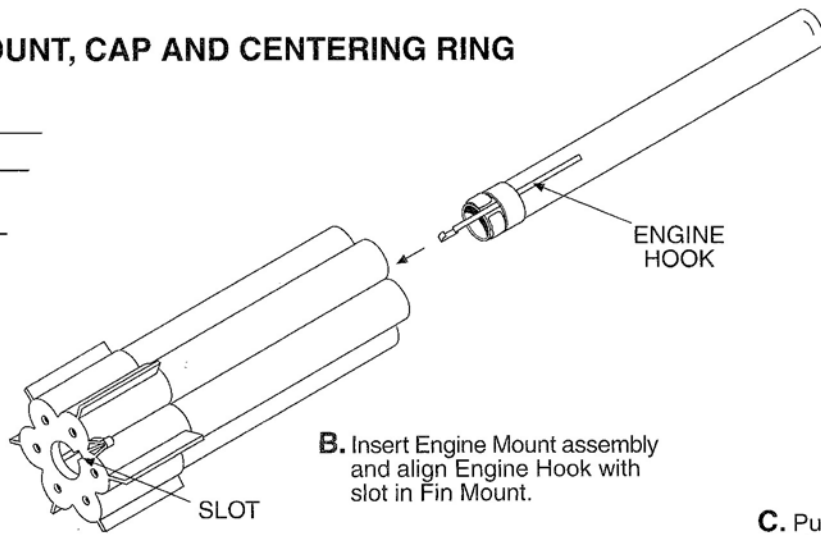

B. Insert Engine Mount assembly and align Engine Hook with slot in Fin Mount.

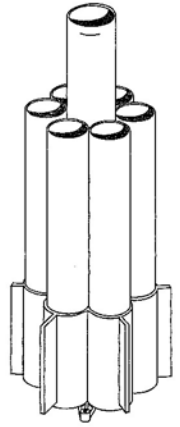

C. Push Engine Mount into place with end of the tube stopping on the shoulder of the Fin Mount. Let dry.



D. Apply tube type plastic cement to inside of Cap where shown.

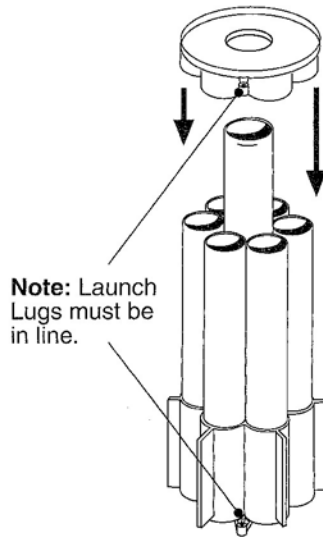

E. Turn Cap over, align Launch Lugs and slide over Engine Mount Tube and onto Tank Tubes. Let dry completely.

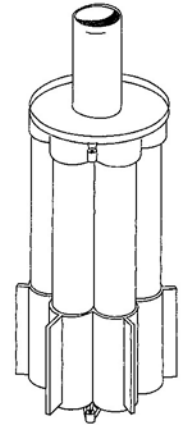

COMPLETED ASSEMBLY

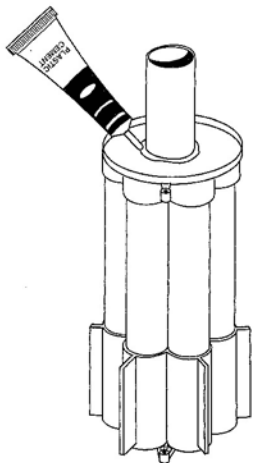

F. Apply tube type plastic cement to Tube/Cap joint. Let dry completely.

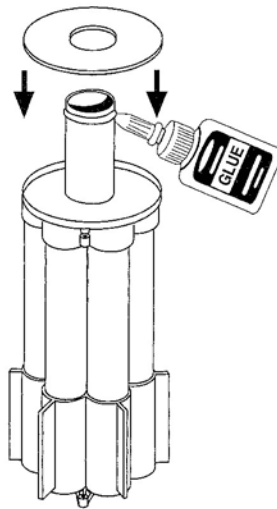

G. Apply Carpenter's glue around tube at the 1/8" (3 mm) mark. Slide Centering Ring onto Tube, even with mark. Let dry completely.

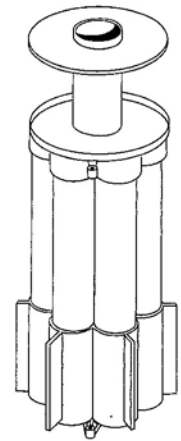

COMPLETED ASSEMBLY

X PRIZE is a registered trademark of the X PRIZE Foundation and is used by permission.



ESTES® ENGINES: D12-3, D12-5

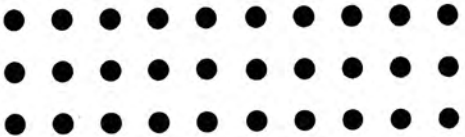

ANSARI
PRIZE®

SPACE TRANSPORT
CORPORATION

SPACE TRANSPORT
CORPORATION

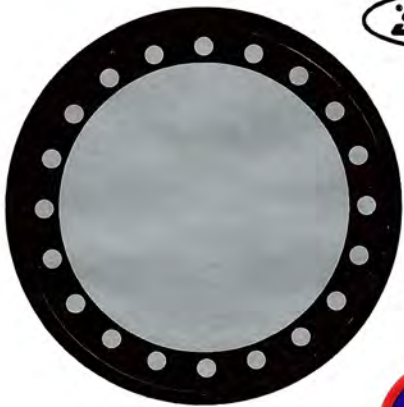

ANSARI
PRIZE®

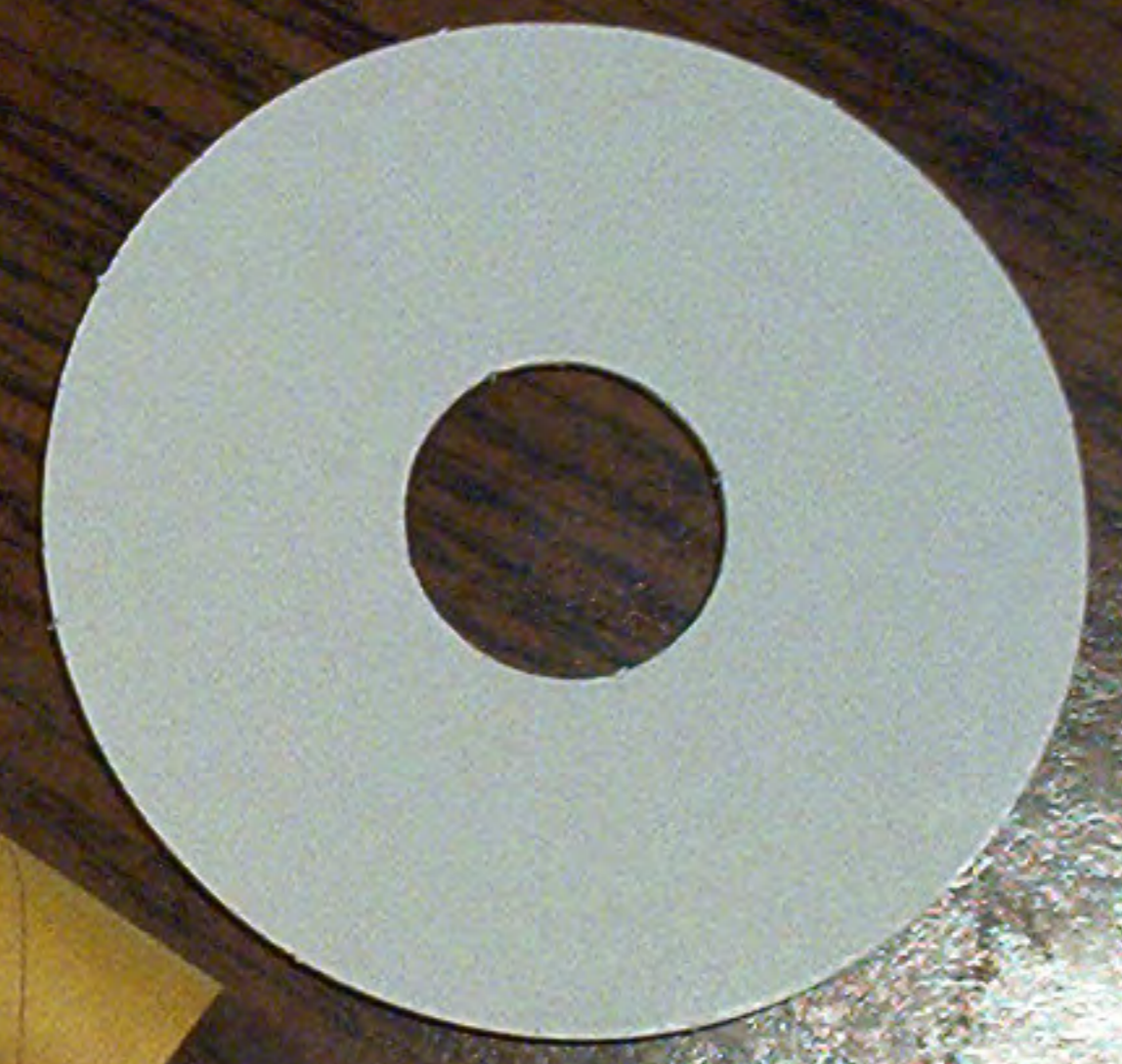
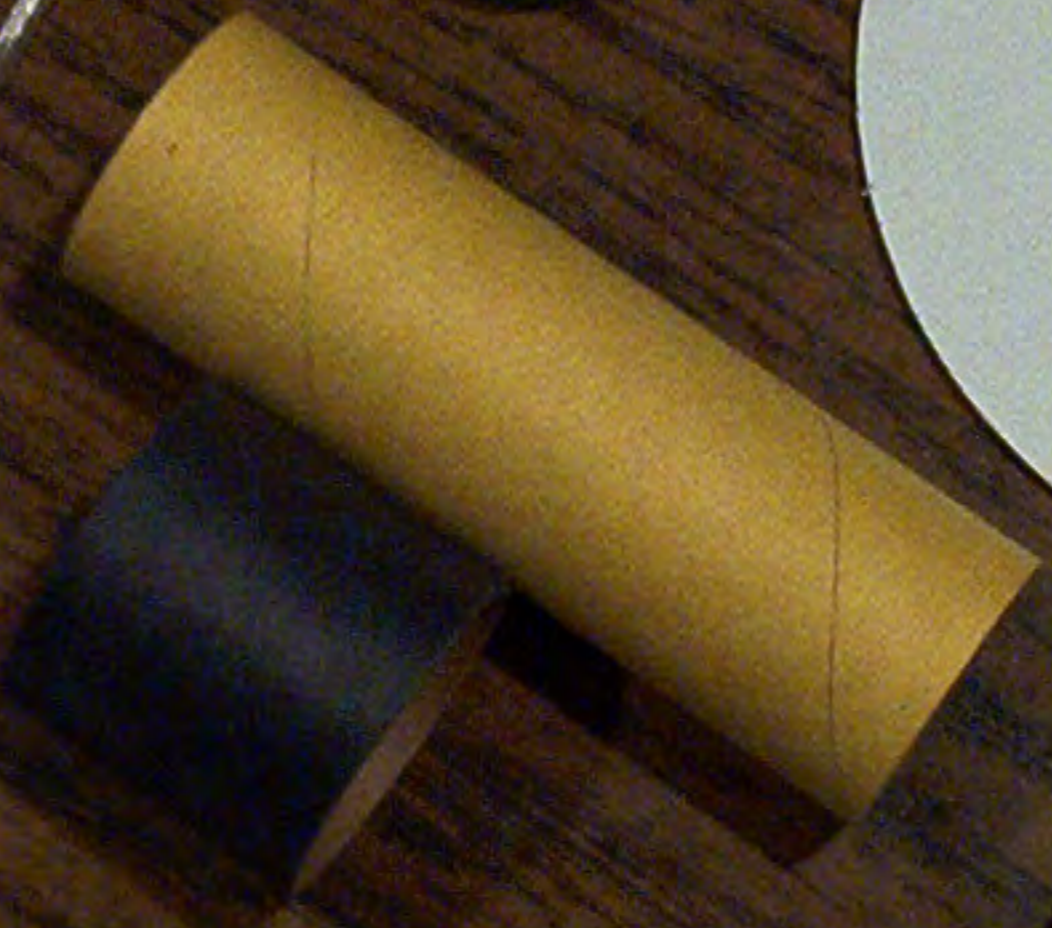
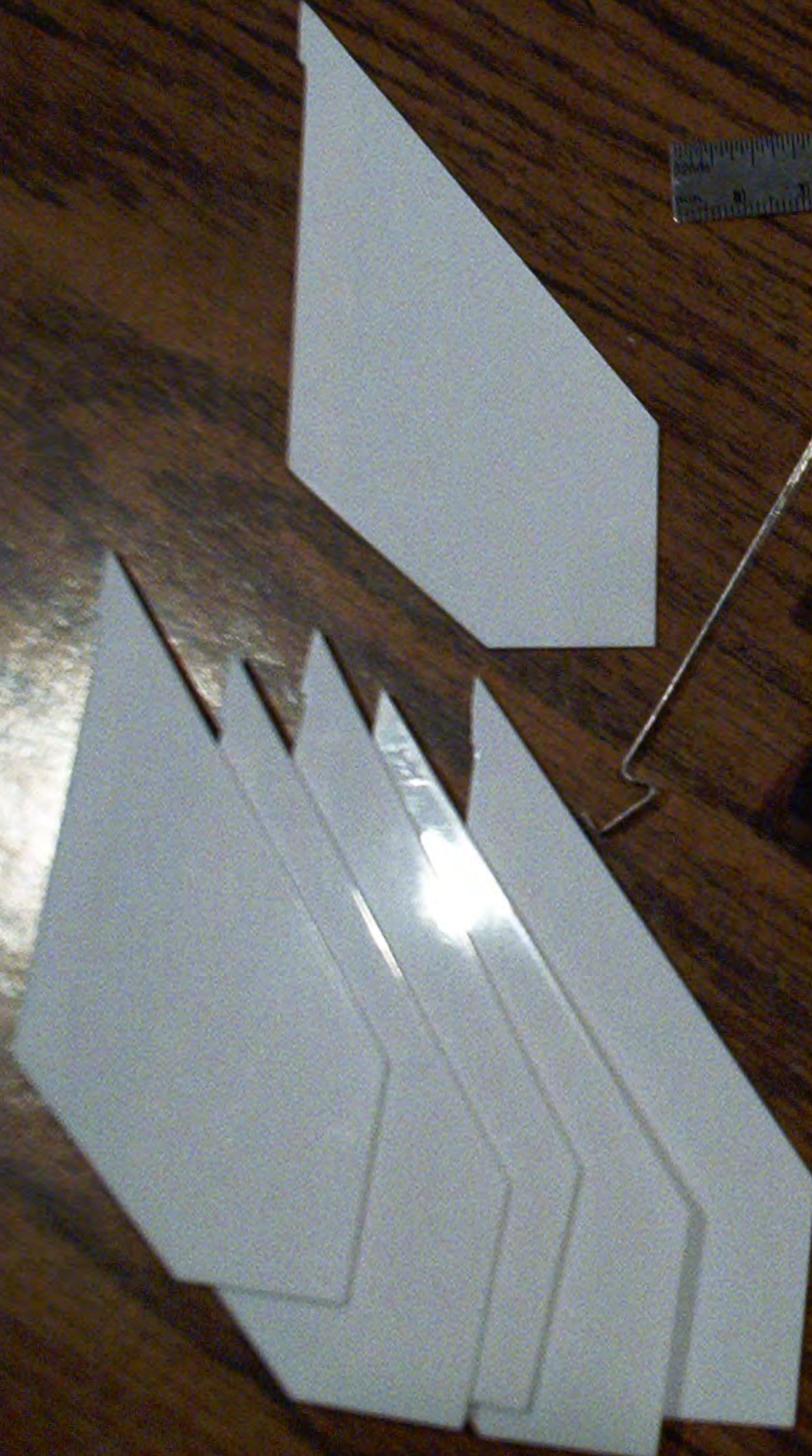



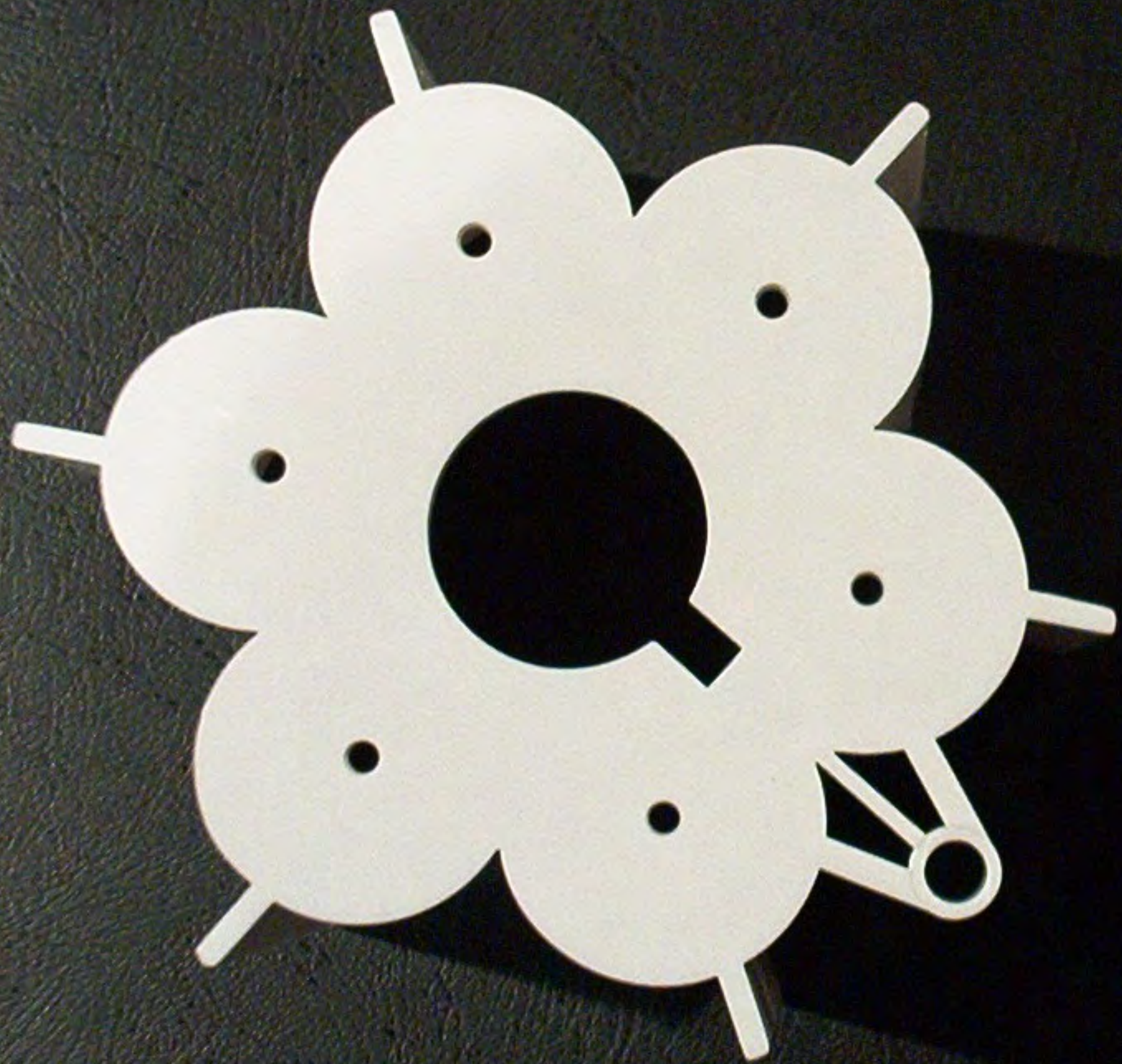

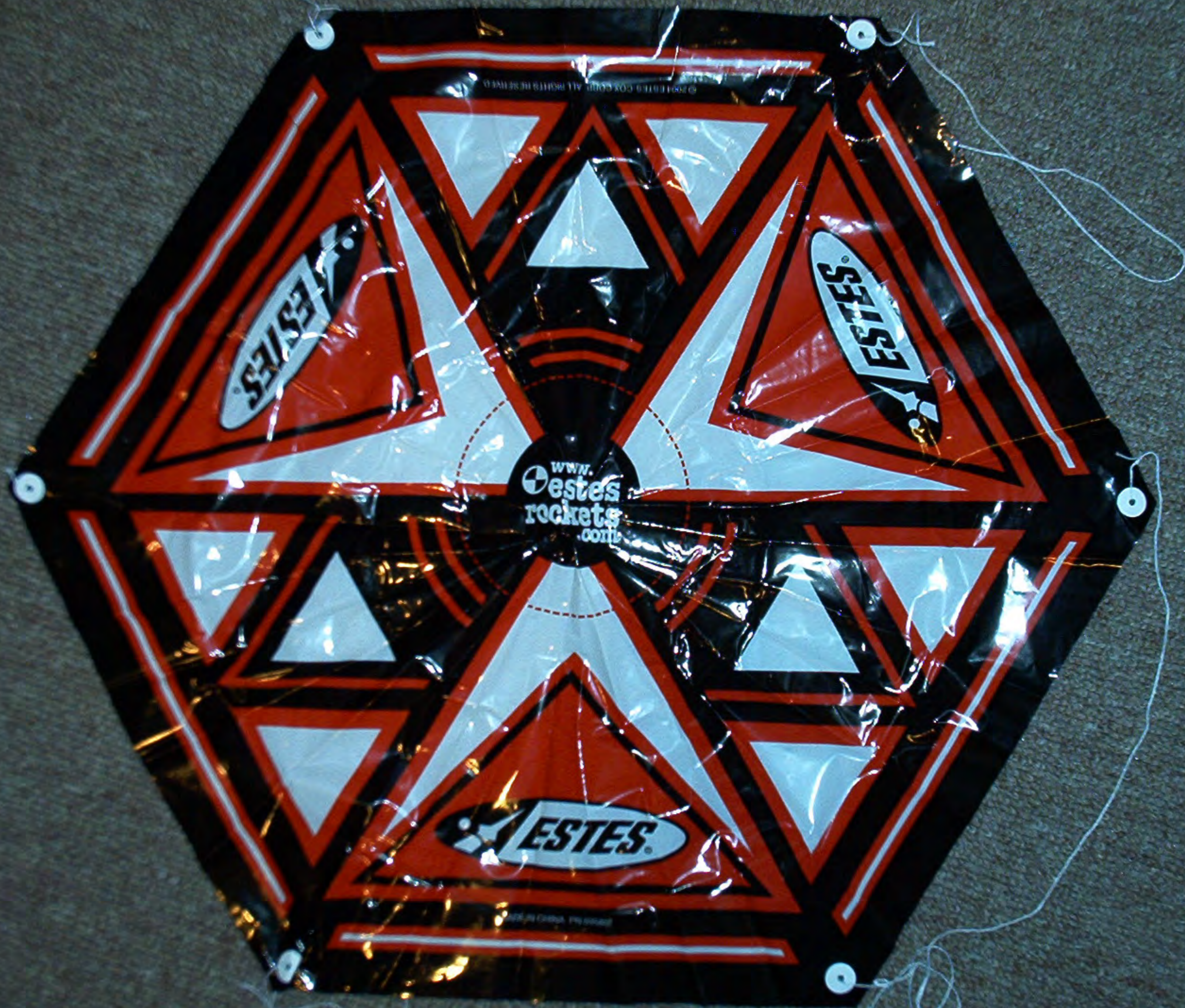

© 1998 ESTES ROCKET COMPANY. ALL RIGHTS RESERVED.

www.
estes
rockets
com

ESTES

MADE IN CHINA. 100% POLYESTER