





A DAMON COMPANY

ESTES INDUSTRIES  
1295 H STREET  
PENROSE, COLORADO 81240 USA

# SPACE SHUTTLE COLUMBIA

#1385

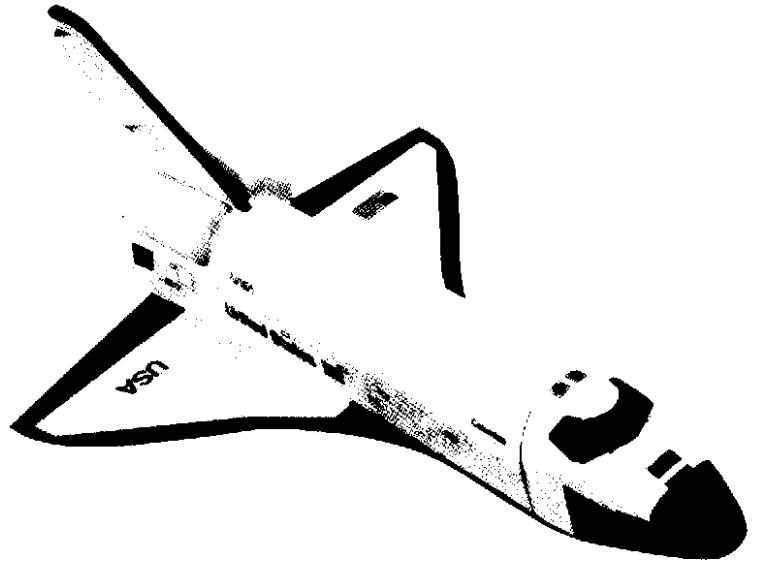

## PARTS AND SUPPLIES

Locate the parts shown below and lay them out on the table in front of you. In addition to the parts included in the kit you will also need:

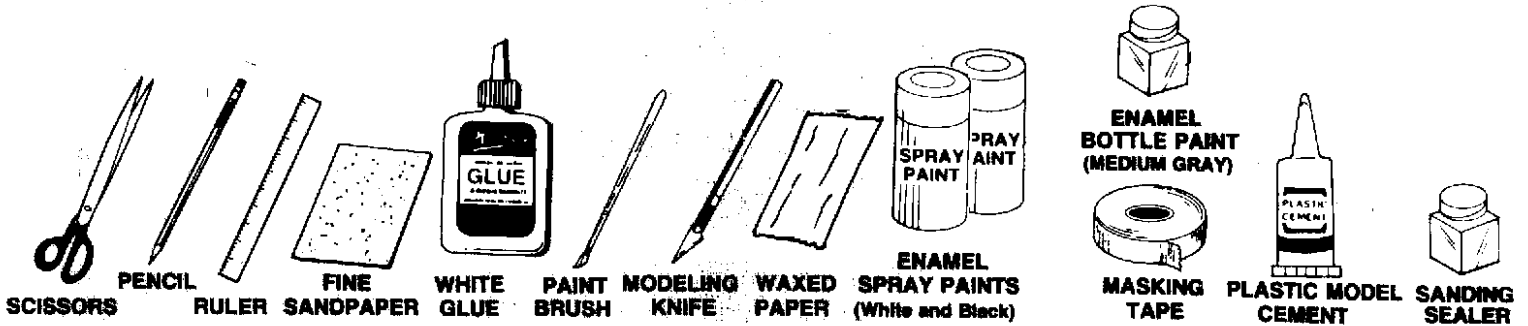

## ASSEMBLY TIP

Read all instructions before beginning work on your model. Make sure you have all parts and supplies. Test-fit all parts together before applying any glue. If any parts don't fit properly, sand as required for precision assembly.

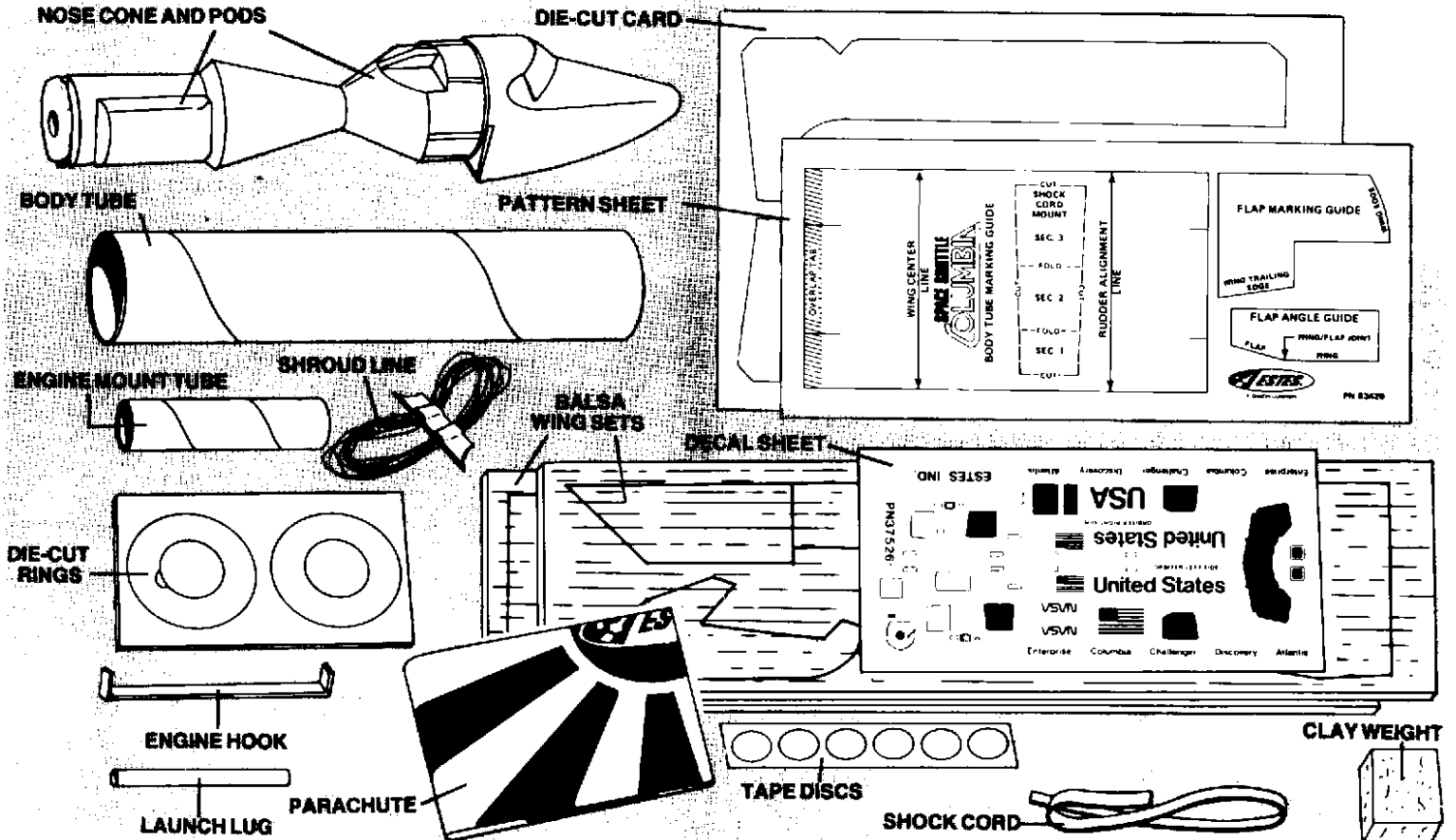

# ROCKET ASSEMBLY

## 1

- Mark engine tube 1/4 inch, 1 inch, and 2 1/2 inches from one end.
- Cut 1/8 inch slit at 2 1/2 inch mark.
- Insert one end of engine hook into slit.
- Wrap masking tape around assembly twice at 1 inch mark.
- Remove centering rings from die-cut card. Lightly sand rings if needed for proper fit.
- Slide notched ring onto rear of tube, up to 1/4 inch mark. Slide remaining ring onto front of tube down to 2 1/2 inch mark. Apply glue to both sides of ring/tube joints.

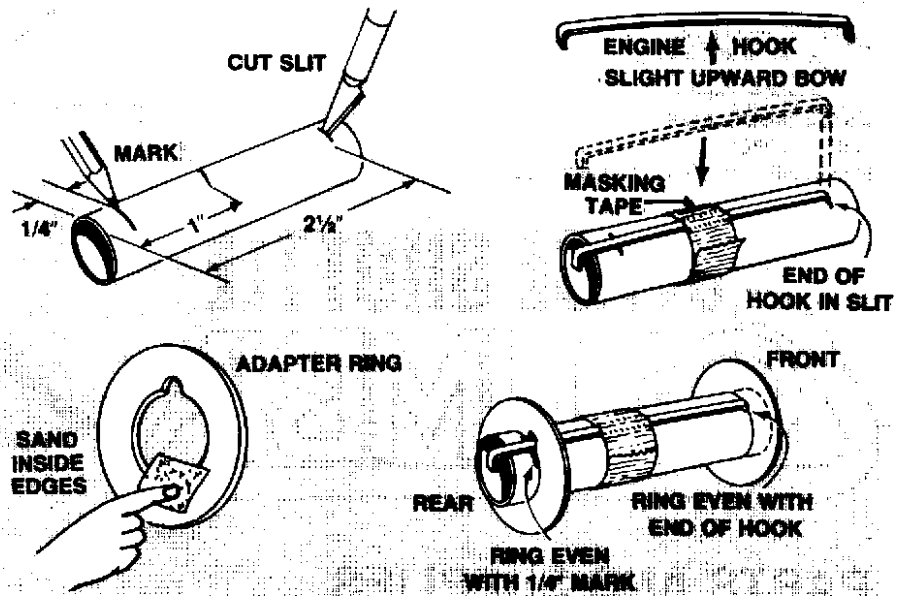

## 2

- Fine-sand die-cut balsa sheet. Carefully remove fin and wing parts by freeing edges with sharp knife.
- Stack alike parts together and lightly sand to remove any rough edges being careful to leave edges square and sharp cornered.

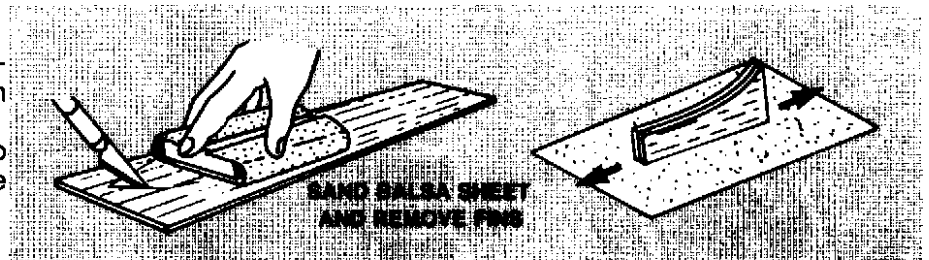

## 3

- Lay waxed paper on a flat surface.
- Glue wing sections together as shown.
- Cover with waxed paper and weight assembly down flat and allow to dry.

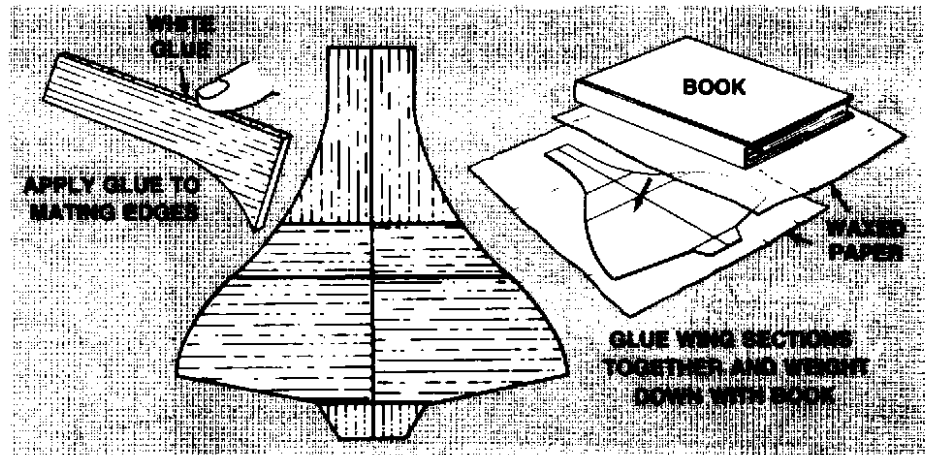

## 4

- Remove rudder drag brake from die-cut paper.
- Fold on lines and glue as shown.
- Locate one of two rudder fins. Discard other rudder.
- Test-fit drag brake into rudder, sand opening until brake fits properly. Apply glue and position as shown.

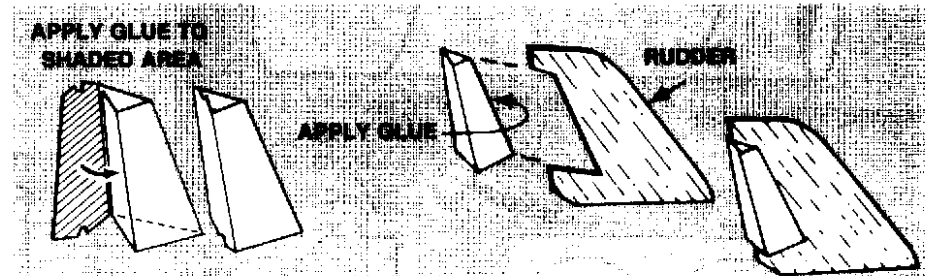

## 5

- Cut out body tube marking guide from pattern sheet.
- Wrap guide around the body tube and tape. Mark tube at arrows. Remove guide.
- Draw straight lines connecting each pair of marks the length of tube.
- Extend lines over edge of tube as shown.

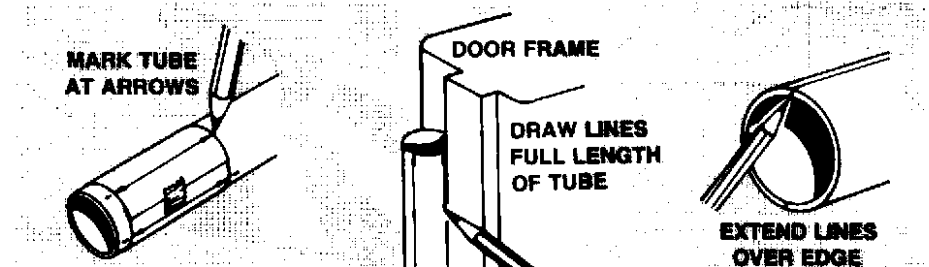

## 6

- Make a mark  $1\frac{1}{8}$  inches from rear edge on center line of wing and 1 inch on each side of center line as shown.
- Apply glue to center line of wing. Position body tube on wing alignment line using wing center line as guide.
- Rear edge of tube should be at  $1\frac{1}{8}$  inch mark. Check for proper alignment.

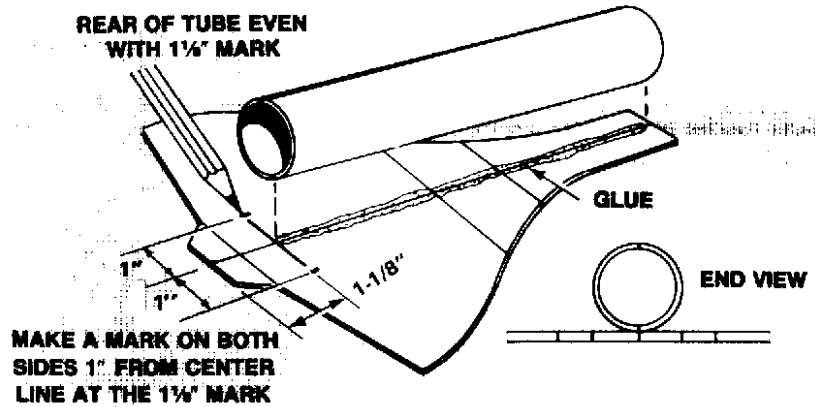

## 7

- Carefully remove fuselage sides from die-cut paper.
- Fold glue tabs as shown. Apply a thin line of glue along tabs.
- Position along side of body tube with front edge even with front edge of wing (not body tube).
- Position rear portion of fuselage side next to 1 inch mark as shown. Repeat procedure for other side.

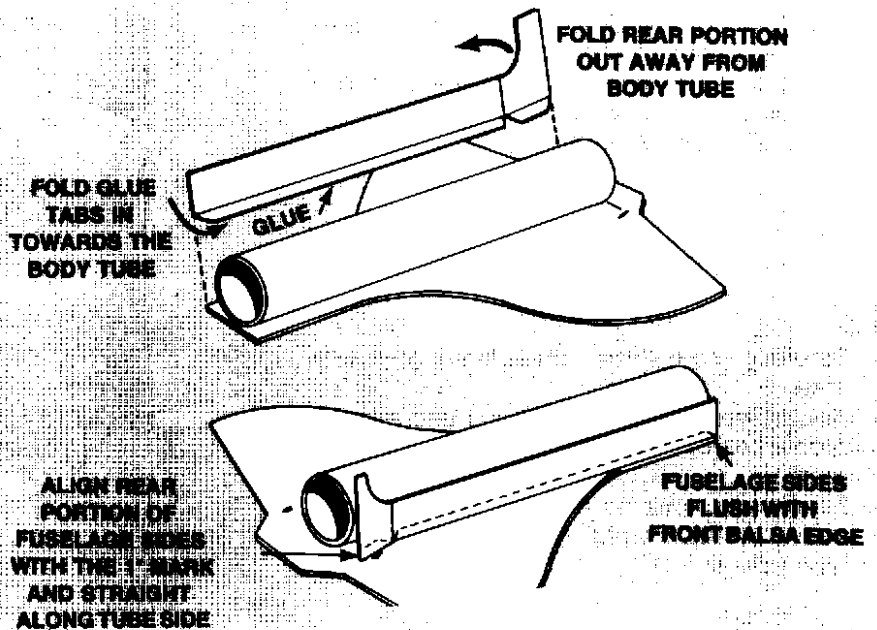

## 8

- Apply glue along inside edge of fuselage side.
- Press into place onto side of tube. Run finger back and forth along edge until glue sets and there are no gaps.
- Repeat procedure for other side.

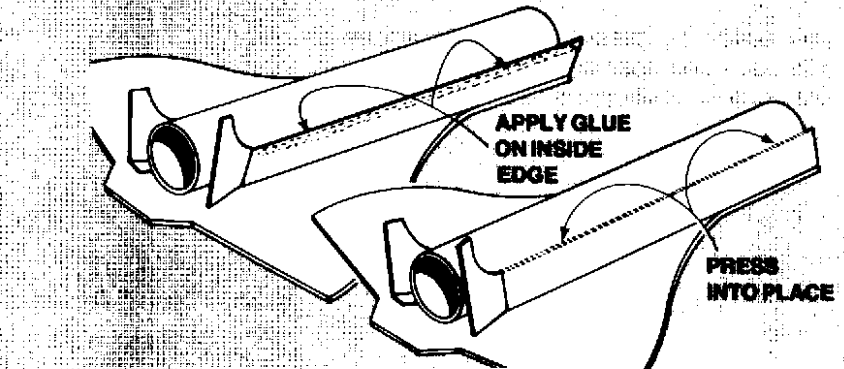

## 9

- Apply a thin coat of glue to underside of fuselage side's upper section.
- Glue into place. Repeat for other side.

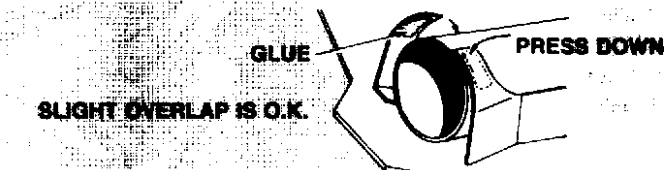

## 10

- Test-fit engine mount into place as shown. Sand if necessary for a smooth fit.
- Remove and apply a ring of glue around inside rear of body tube.
- Slide engine mount into place with rear centering rings flush with end of tube and hook in position shown.

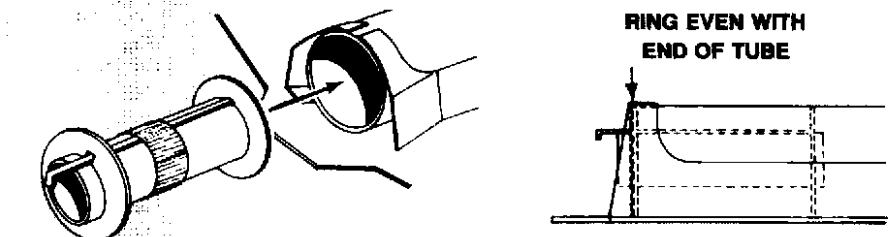

## 11

- Glue rudder on alignment line, making sure rear of rudder is even with end of tube.
- Adjust rudder to project straight out from tube and perpendicular to wings.

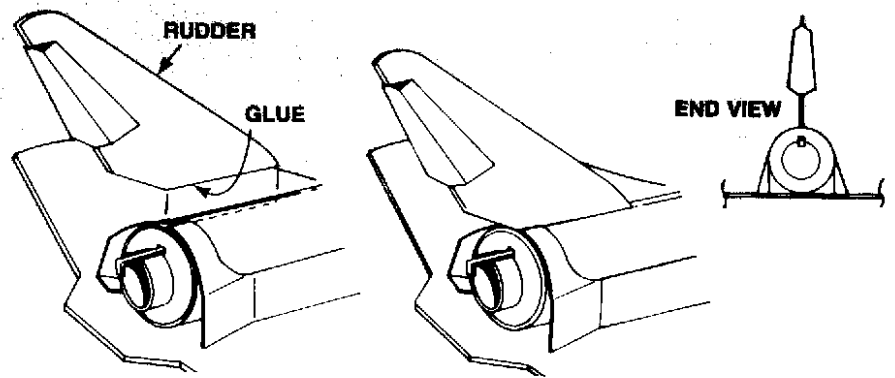

## 12

- Carefully cut the OMS pods from the nose cone and pods plastic part.
- Using a sharp knife, make several light cuts instead of one heavy cut.
- Sand all edges of pods smooth.

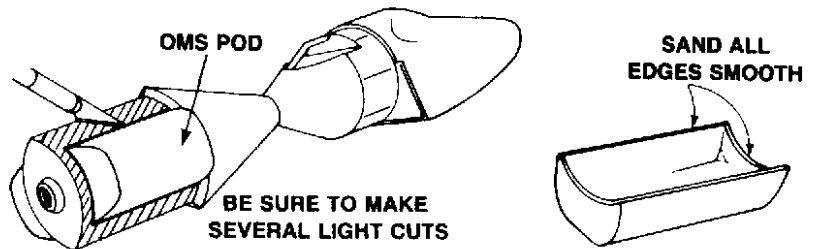

## 13

- Carefully score nose cone/adapter joint with knife.
- Holding nose cone in one hand and adapter in other, carefully bend at joint until parts snap apart.
- Sand nose cone to remove excess plastic around cone. Carefully remove any plastic flash from eyelet.

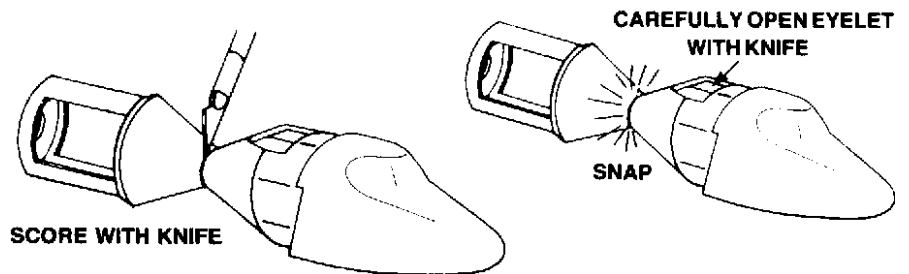

## 14

- Apply tube-type plastic cement to edges of OMS pods and position them as shown.
- Hold pods in position until cement sets.

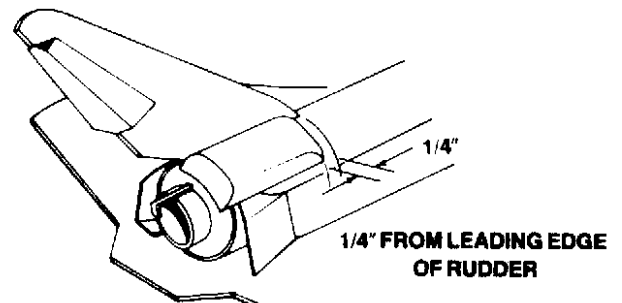

## 15

Follow instructions in next two steps exactly to make shuttle fly properly.

- Cut out flap marking guide from pattern sheet.
- Position guide as shown and mark along inside edge of guide. **MARK AND CUT ONLY ONE WING.**
- Cut through wing along lines with modeling knife. **CUT ONLY ONE WING.**

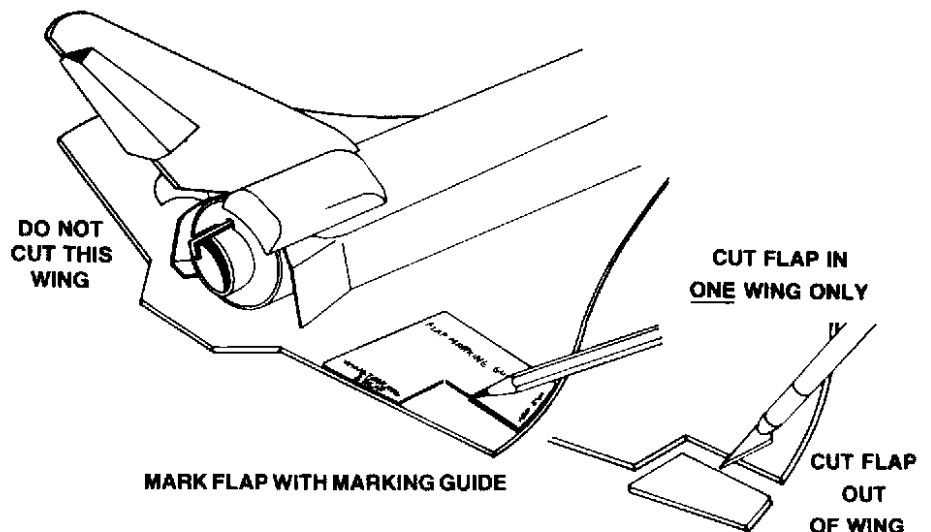

## 16

- Cut flap angle guide out of pattern sheet.
- Glue edge of flap to wing as shown.
- Check angle of flap with angle guide. After glue has dried check angle again. If incorrect adjust by heating glue joint with light bulb for 30 seconds. Hold angle until joint is cool.

**GLUE FLAP TO WING AND POSITION ANGLE GUIDE ON WING.**

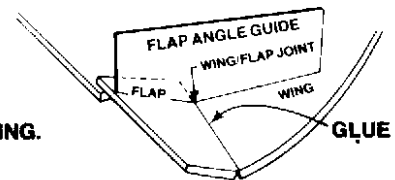

**BEND FLAP UP TO PROPER ANGLE**

## 17

- Glue launch lug on wing bottom center line 3 inches from rear of wing. Make certain launch lug is parallel to center line.



**GLUE LAUNCH LUG 3" FROM REAR OF THE WING**

## 18

- Cut out shock cord mount from marking guide.
- Fold on dotted lines. Spread glue on section 1 and lay shock cord into glue. Fold over and apply glue to section 2 and back of section 1. Lay shock cord as shown and fold again.
- Clamp assembly together until glue sets.

**SHOCK CORD**

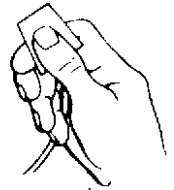
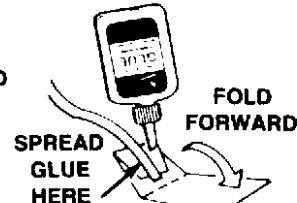
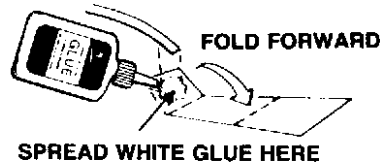

## 19

- Apply glue to inside front of body tube about 1 to 2 inches from end. Glue area should be same size as shock cord mount.
- Press mount firmly into glue as shown.
- Hold until glue sets.

**SET BACK TO ALLOW FOR NOSE CONE**

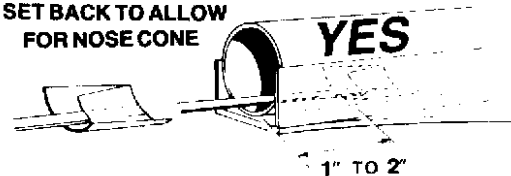

## 20

- Apply glue reinforcements to all glue joints.
- Support rocket in a level position while glue dries.
- After glue is completely dry, apply sanding sealer to all wood parts. When sealer is dry, lightly sand sealed surfaces.
- Repeat sealing and sanding until wood grain is filled and smooth.

**APPLY THIN LINE OF GLUE**

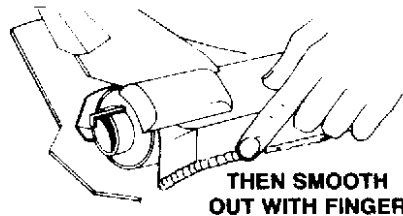

**APPLY SANDING SEALER**

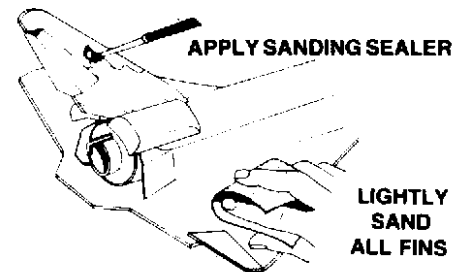

## 21

- Roll clay balance weight between hands to make a snake 1/8 inch in diameter.
- Poke clay through hole in nose cone. Use pencil or dowel to push and pack clay tightly into front of cone. Use all the clay provided.

**ROLL CLAY INTO "SNAKE"**

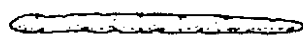

**INSERT CLAY—PACK CLAY TIGHTLY INTO FRONT OF NOSE CONE**

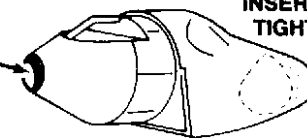

## 22

- Cut out parachute on edge lines.
- Cut three 22 inch lengths of shroud line.
- Form small loops with shroud line ends and press onto sticky side of tape discs.
- Attach tape discs with line ends to top of parachute as shown.
- Firmly press tape discs into place until both tape discs and parachute material are molded around shroud line loops.
- Pass shroud line loops through eyelet on nose cone. Pass parachute through loop ends and pull lines against the nose cone.
- Tie free end of shock cord to nose cone eyelet.

**CUT OUT 'CHUTE**

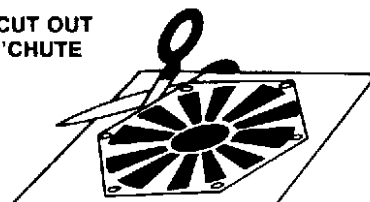

**CUT THREE LENGTHS OF SHROUD LINE**

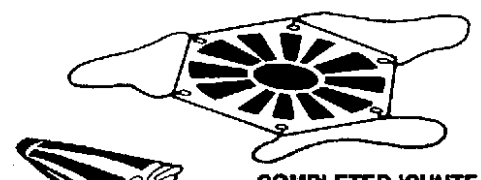
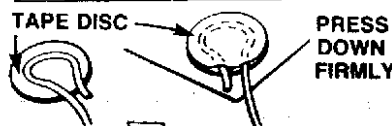
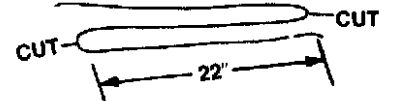

**PUSH LINES THRU EYELET**

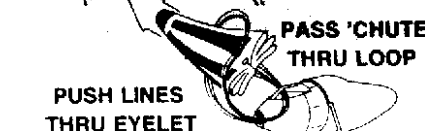

**PULL TIGHT**



# PAINING AND DETAILING

Before painting, wipe the model thoroughly with a damp cloth to remove oily fingerprints. Spray the model white. You need not paint the bottom, but make sure you have a solid covering of white down to where the black color will begin. Spray in several light coats rather than one heavy coat. If you wish to spray the black areas, you must allow the white to dry for at least four hours. If you are going to brush on the black and gray, let the white dry for one hour. After the paint on the Shuttle is dry, apply masking tape along the color break lines between black (or gray) and white portions. (See illustrations.) Cover the white upper portion with paper held in place with tape. Make sure there are no openings where over-spray could sift through onto the white. After the paint is dry, carefully remove the masking material. NOTE: If you brush paint the black, disregard masking instructions. Carefully brush paint the indicated gray areas on the body.

USE ROLLED UP PAPER FOR ROCKET HOLDER

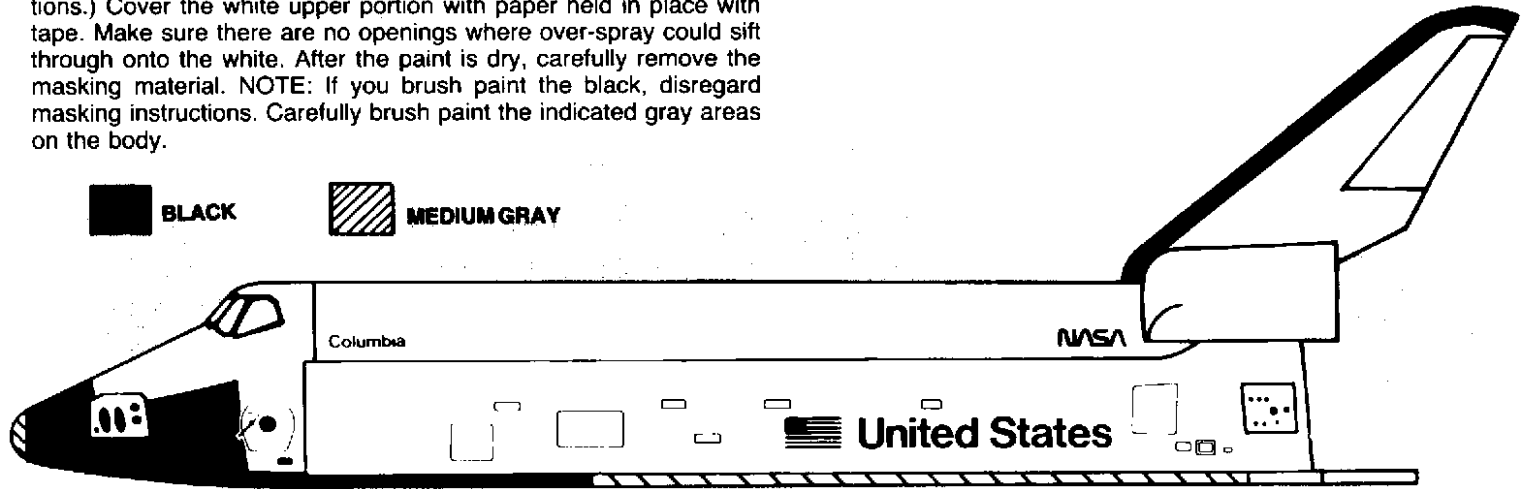
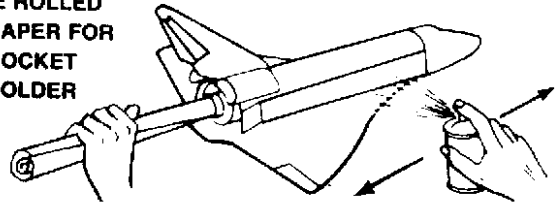

LEFT SIDE VIEW

# DECAL PLACEMENT

When all paint is dry, apply the decals in the positions shown. (A) Cut only one decal at a time from sheet. (B) Submerge decal in lukewarm water until decal slides on backing paper (usually 15 to 30 seconds). (C) Gently slide decal from backing paper onto model. (D) Move decal into exact position and carefully blot away excess water with a soft cloth. (E) If the decal "sticks" before you have it in position, apply water over the decal with a brush. This will permit the decal to be moved. (F) Smooth out all wrinkles and air bubbles before the decal dries.

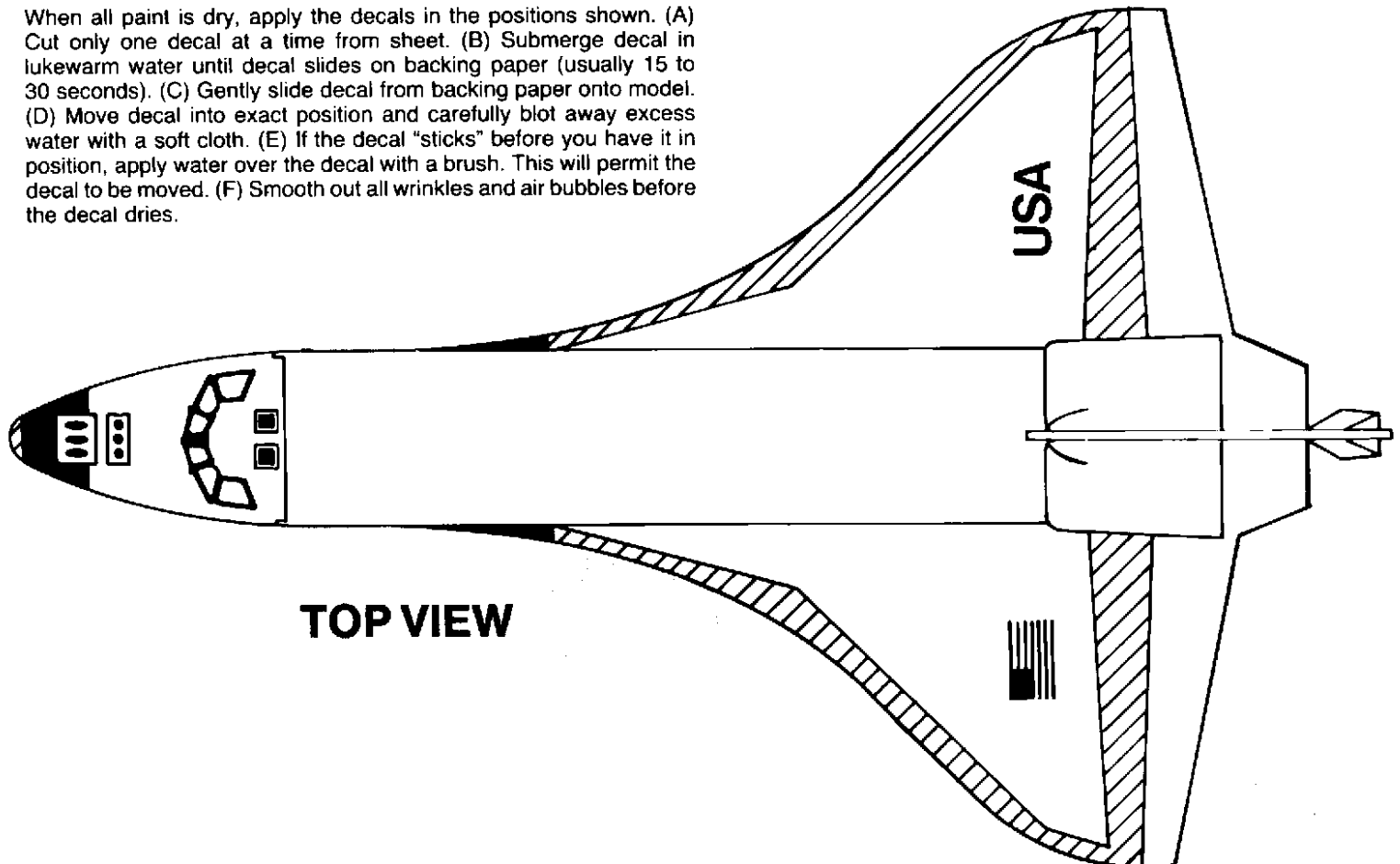

TOP VIEW

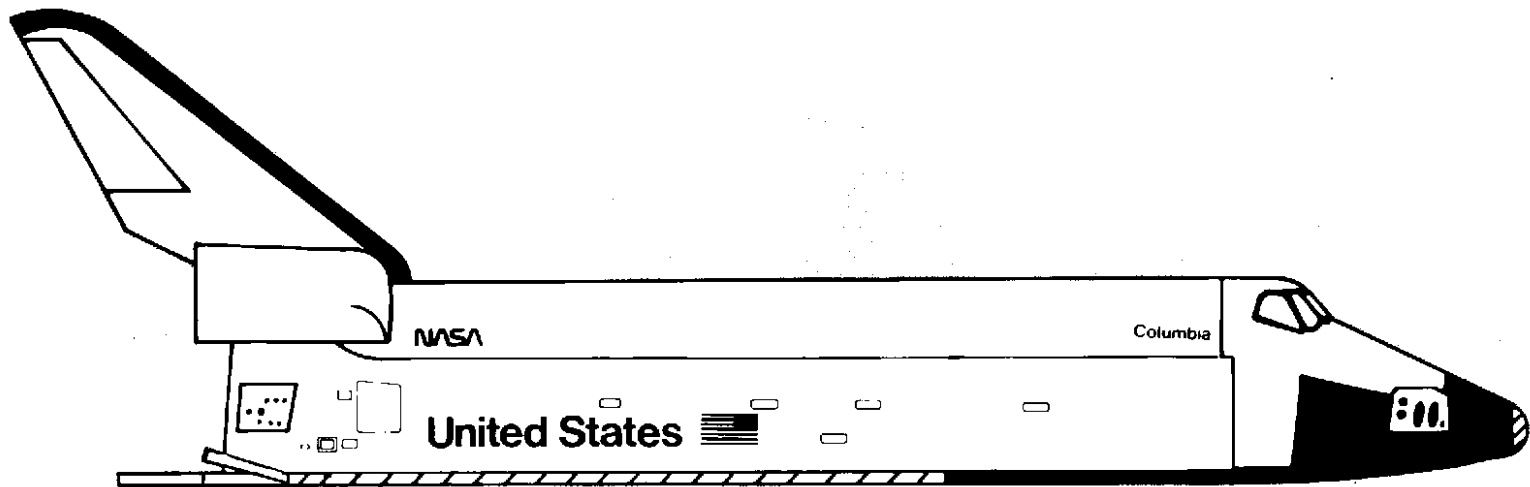

**RIGHT SIDE VIEW**

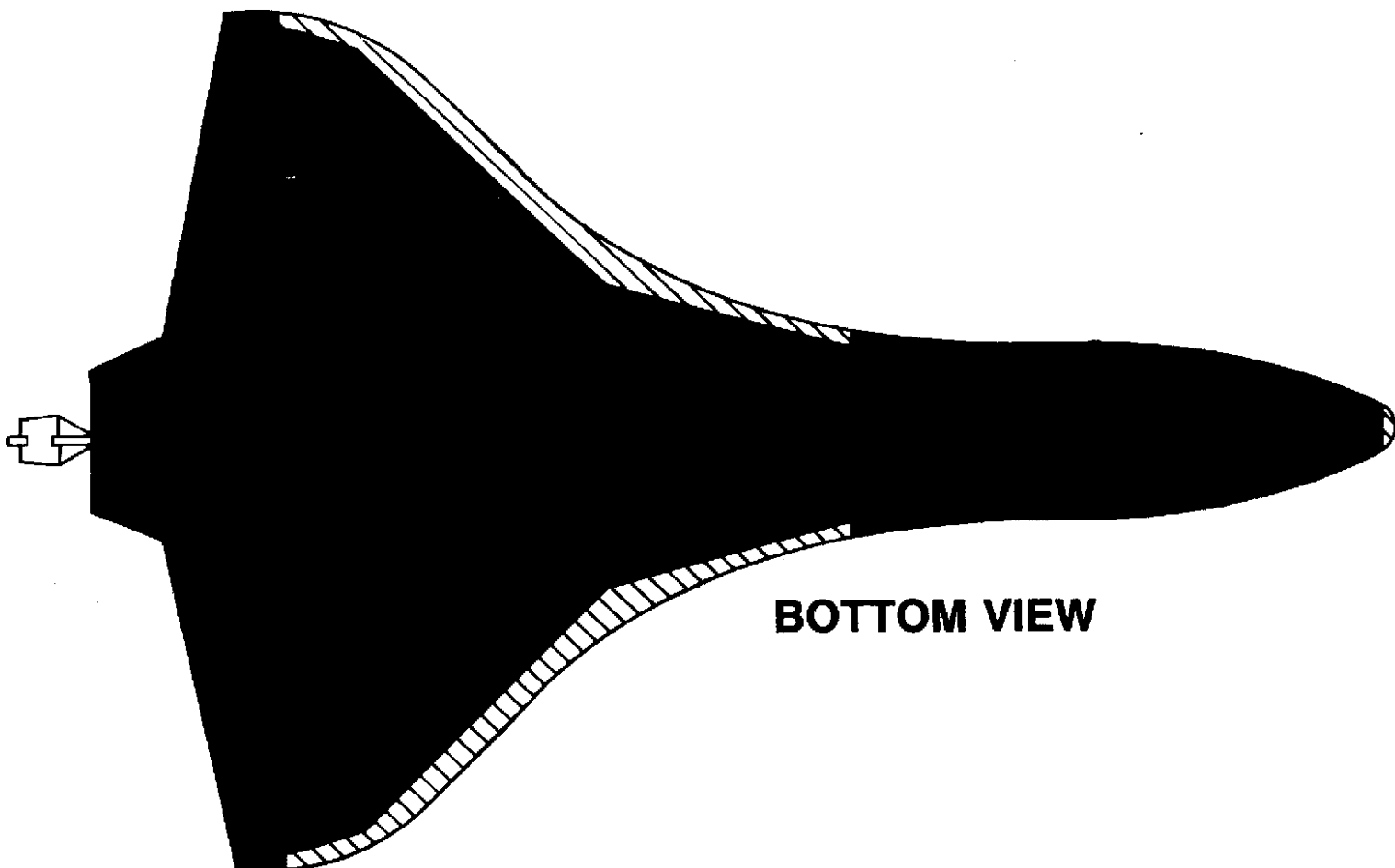

**BOTTOM VIEW**



## ROCKET PREFLIGHT

CRUMPLE AND INSERT 3 SQUARES OF RECOVERY WADDING

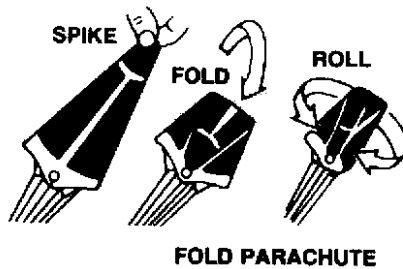
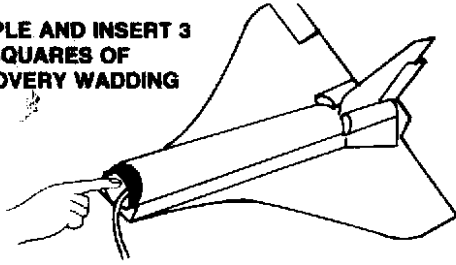

FOLD PARACHUTE

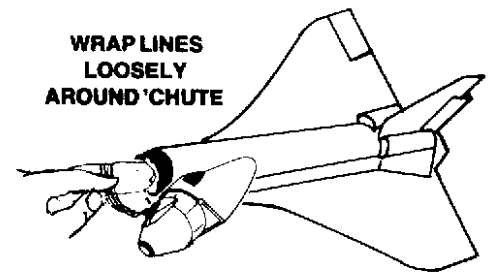

INSERT PARACHUTE IN ROCKET

## PREPARE ENGINE

SEPARATE THE IGNITERS

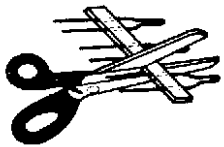

ENGINE

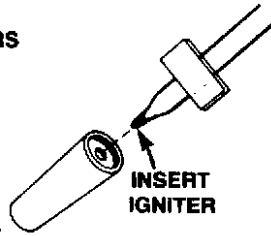

INSERT IGNITER

IGNITER TIP MUST TOUCH PROPELLANT DEEP INSIDE NOZZLE OPENING



FOLD OVER AND BEND TIPS

APPLY AND FIRMLY PRESS TAPE DISC OR MASKING TAPE IN PLACE

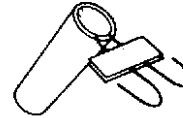

HOOK MUST LATCH OVER END OF ENGINE

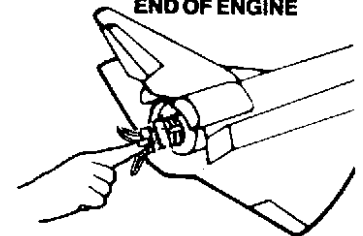

INSTALL ENGINE IN ROCKET

## LAUNCH SUPPLIES

To launch your rocket you will need the following items:

- An Estes model rocket launching system
- Estes Parachute Recovery Wadding (No. 2274)
- Recommended Engines: A8-3, B4-4, B6-4, B8-5, C6-5

Use an A8-3 engine for your first flight to become familiar with your rocket's flight pattern.

## FLYING YOUR ROCKET

Choose a large field away from power lines, tall trees, and low flying aircraft. Try to find a field at least 250 feet square. The larger the launch area, the better your chance of recovering your rocket. Football fields and playgrounds are great.

Launch area must be free of dry weeds and brown grass.

Launch only during calm weather with little or no wind and good visibility.

Don't leave parachute packed more than a minute or so before launch during cold weather [colder than 40° Fahrenheit (4° Celsius)].

## MISFIRES

Failure of the rocket engine to function properly is nearly always caused by a failure to install the igniter correctly. This failure permits the igniter to heat and burn into two pieces without igniting the engine.

## FOR YOUR SAFETY AND ENJOYMENT

Always follow the NAR-HIA\* MODEL ROCKETRY SAFETY CODE while participating in any model rocketry activities.

\*National Association of Rocketry-The Hobby Industry of America

## COUNTDOWN AND LAUNCH

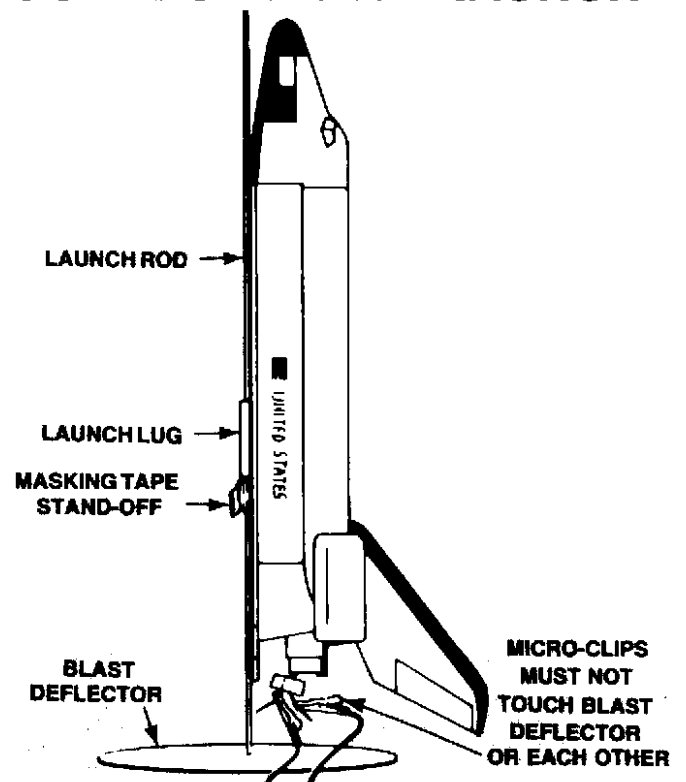

- ⑤ REMOVE SAFETY KEY to disarm the launch controller.
- ④ Remove safety cap and slide launch lug over launch rod to place rocket on launch pad. Make sure the rocket slides freely on the launch rod.
- ③ Attach micro-clips to the igniter wires. Arrange the clips so they do not touch each other or the metal blast deflector. Attach clips as close to protective tape on igniter as possible.
- ② Move back from your rocket as far as launch wire will permit (at least 15 feet).
- ① INSERT SAFETY KEY to arm the launch controller.

**LAUNCH!!!** PUSH AND HOLD LAUNCH BUTTON UNTIL ENGINE IGNITES

Remove safety key—Replace cap on rod.

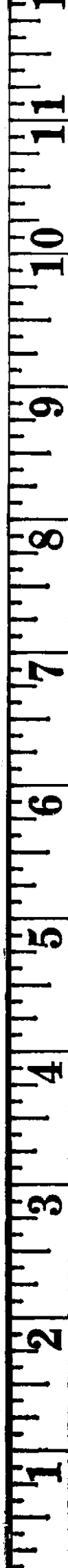
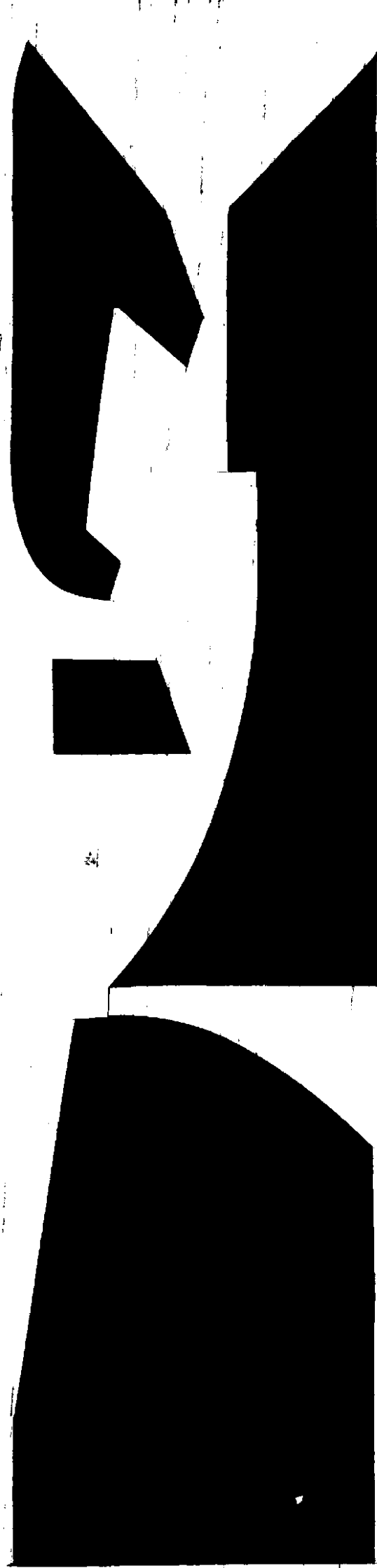

**FOR SAFETY OF NAVIGATION US**

Enterprise   Columbia   Challenger   Discovery   Atlantis



VSVN  
VSVN

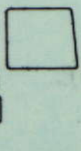

**United States**



ORBITER LEFT SIDE

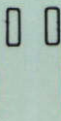

**United States**



ORBITER RIGHT SIDE



**USA**



FRONT



PN37526

**ESTES IND.**

Enterprise   Columbia   Challenger   Discovery   Atlantis

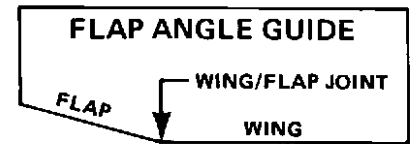
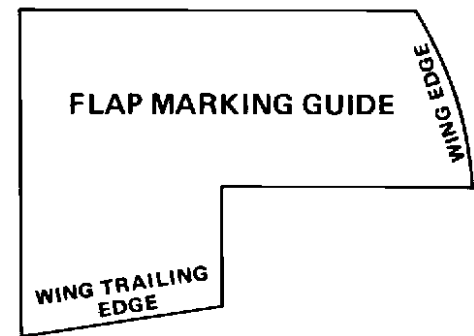
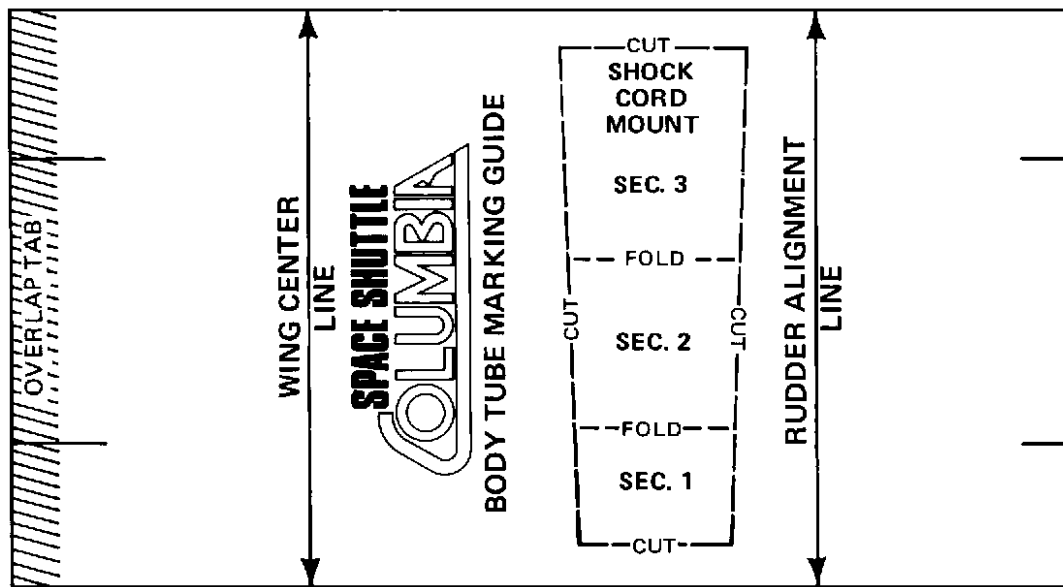

PN 83420

