

Astron ALPHA III



- EASY TO ASSEMBLE
- PLASTIC NOSE CONE & FIN UNIT
- GREAT FOR DEMONSTRATIONS

SKILL LEVEL 1

1—Beginner 2—Intermediate 3—Craftsman 4—Advanced 5—Expert

SPECIFICATIONS

Length 12.25" (31.1 cm.)

Weight 1.2 oz. (33.9 g.)

Body Dia. 0.976" (24.8 mm.)

Parachute Recovery

RECOMMENDED ENGINES

1/2A6-2 A8-3 B4-4 B6-4 C6-5

Use A8-3 for first flights.

Engines and launcher not included.

K-56
#1256

ESTES INDUSTRIES
PENROSE, COLO. 81240

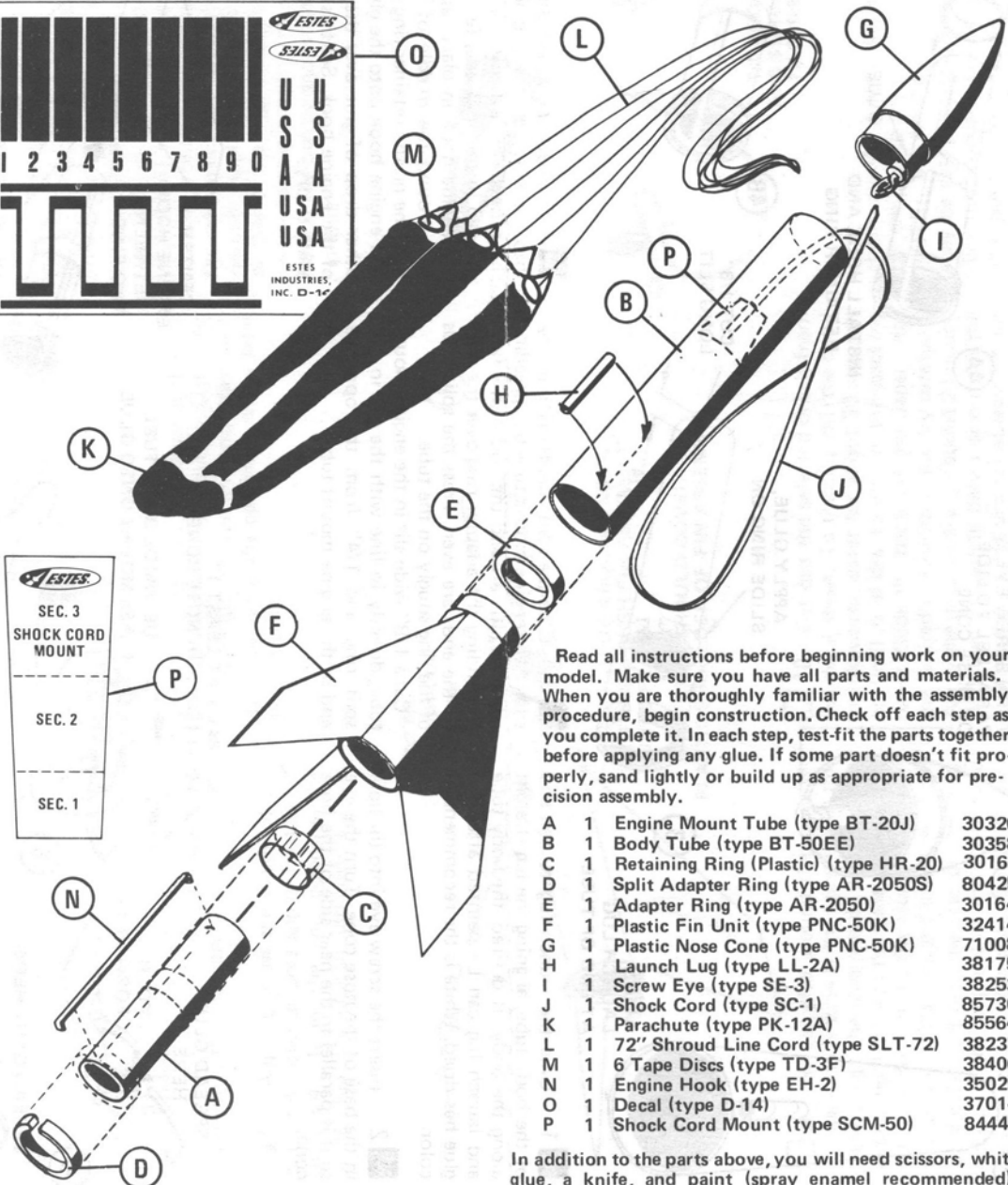
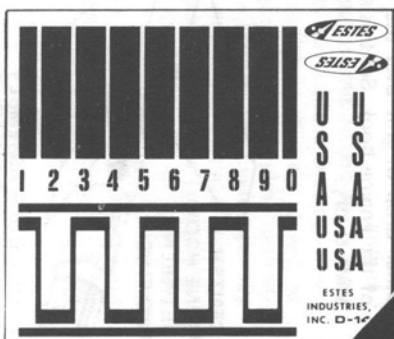

Read all instructions before beginning work on your model. Make sure you have all parts and materials. When you are thoroughly familiar with the assembly procedure, begin construction. Check off each step as you complete it. In each step, test-fit the parts together before applying any glue. If some part doesn't fit properly, sand lightly or build up as appropriate for precision assembly.

A	1	Engine Mount Tube (type BT-20J)	30326
B	1	Body Tube (type BT-50EE)	30358
C	1	Retaining Ring (Plastic) (type HR-20)	30168
D	1	Split Adapter Ring (type AR-2050S)	80425
E	1	Adapter Ring (type AR-2050)	30164
F	1	Plastic Fin Unit (type PNC-50K)	32414
G	1	Plastic Nose Cone (type PNC-50K)	71008
H	1	Launch Lug (type LL-2A)	38175
I	1	Screw Eye (type SE-3)	38253
J	1	Shock Cord (type SC-1)	85730
K	1	Parachute (type PK-12A)	85564
L	1	72" Shroud Line Cord (type SLT-72)	38237
M	1	6 Tape Discs (type TD-3F)	38406
N	1	Engine Hook (type EH-2)	35025
O	1	Decal (type D-14)	37014
P	1	Shock Cord Mount (type SCM-50)	84444

In addition to the parts above, you will need scissors, white glue, a knife, and paint (spray enamel recommended).

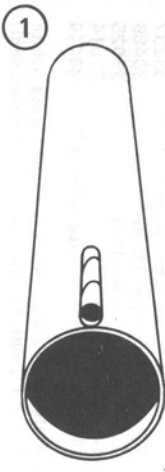

ALIGN LAUNCH LUG AT END OF TUBE

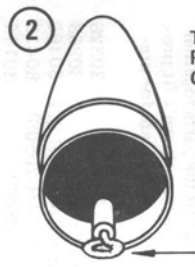

TURN SCREW EYE PARALLEL TO SIDE OF NOSE CONE

1 Glue the launch lug to one end of the body tube, aligning the lug straight along the tube. If desired, the body tube and launch lug can be painted after the glue has dried. White is the recommended color.

2 Insert the screw eye into the hole in the base of the nose cone. Turn the eye so it is parallel to the near side of the nose cone.

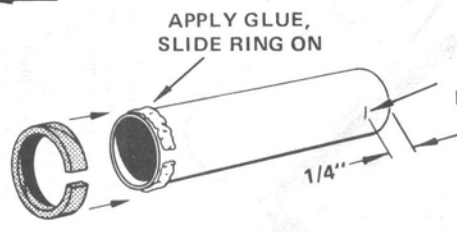

3 Glue the split adapter ring to one end of the engine mount tube by spreading a line of glue around the end of the tube and sliding the adapter ring over the tube so the ends are even. Press the split ends of the ring snugly on the tube.

Cut a 1/8" wide slit in the engine mount tube, directly in line with the gap in the split ring and 1/4" from the opposite end of the engine mount tube.

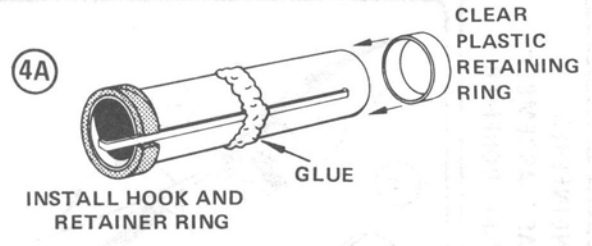

INSTALL HOOK AND RETAINER RING

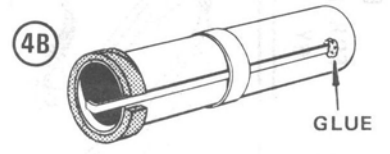

4 Insert one end of the engine hook into the slit. Lay the engine hook along the tube so the other end passes through the gap in the split adapter ring. Holding the engine hook in place, apply a line of glue around the middle of the tube and slide the plastic retaining ring over the tube and engine hook onto the glue. Apply another drop of glue over the forward end of the engine hook. Set this sub-assembly aside to dry.

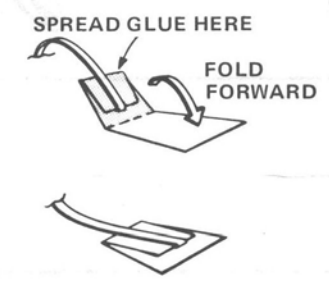
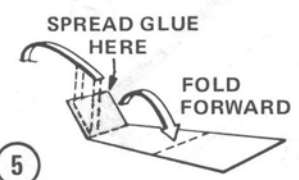

5 Cut out the shock cord mount. Pre-fold it on the dotted lines. Apply glue to section 1 and lay the shock cord end into the glue. Fold this first section over. Spread glue over the back of the first section and the exposed part of section 2. Lay the shock cord as shown and fold over again. Clamp the unit together with your fingers until the glue sets.

6 Apply glue to the inside of the body tube over an area approximately 1" to 1-3/4" from the end opposite the launch lug. The glue should cover a shape

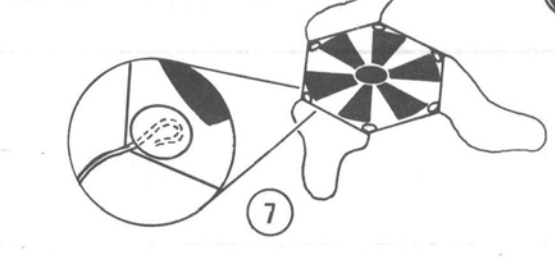
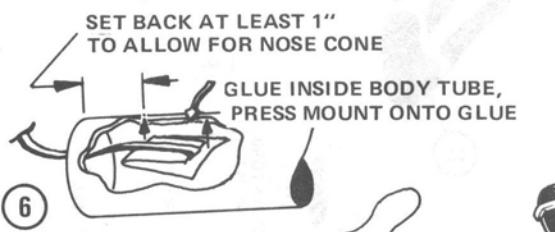

approximately the same as the shock cord mount. Press the mount into the glue and hold it until the glue sets.

7 Cut out the parachute along the edge lines marked on the plastic. Cut three 24" lengths of shroud line and attach one to each point of the parachute with a tape disc as shown.

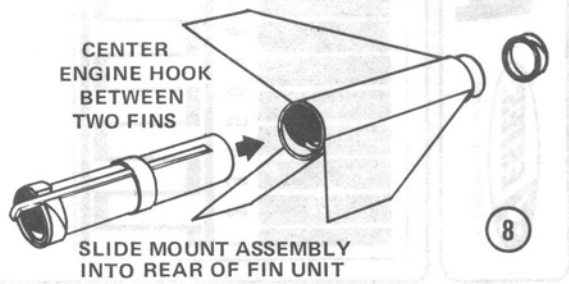

CENTER ENGINE HOOK BETWEEN TWO FINS

SLIDE MOUNT ASSEMBLY INTO REAR OF FIN UNIT

8 Insert the engine mount assembly into the fin unit from the rear. The split adapter ring should fit all the way into the tube portion of the fin unit, the engine hook should be centered between two fins, and the front of the engine mount tube should project 1/4" from the front of the fin unit. Apply glue around the projecting portion of the engine mount tube and slide the remaining adapter ring over the tube until it fits tightly against the front of the fin unit.

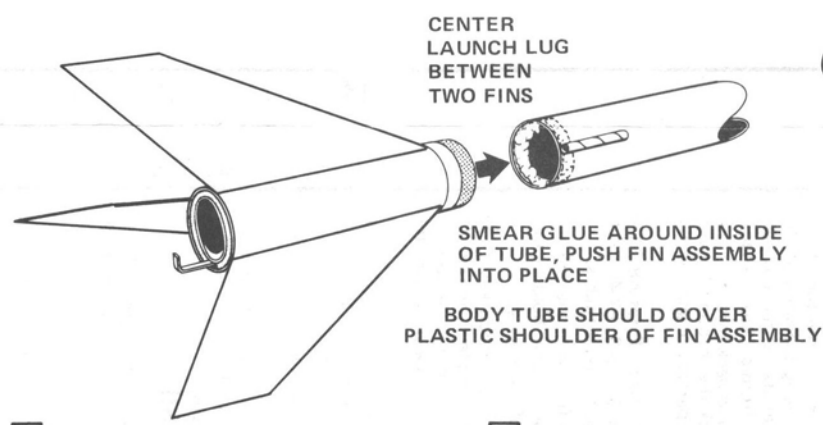

CENTER LAUNCH LUG BETWEEN TWO FINS

SMEAR GLUE AROUND INSIDE OF TUBE, PUSH FIN ASSEMBLY INTO PLACE

BODY TUBE SHOULD COVER PLASTIC SHOULDER OF FIN ASSEMBLY

9 Spread glue around the inside of the main body tube at the same end as the launch lug. The glue should cover an area extending 1/2" into the tube. Line up the tube and fin unit so the launch lug is between two of the fins and insert the front of the fin unit into the rear of the body tube. Tie the free end of the shock cord securely to the nose cone. Tie the shroud lines to the screw eye on the nose cone.

10 Cut out the selected decals from the decal sheet. To transfer, dip the decal in lukewarm water for about 30 seconds or until it slides easily on the backing paper. Slide the decal off the paper onto the desired surface and blot dry carefully. Allow the decal to dry for about 24 hours. (Whether you apply decals or not, let the glue on the rocket dry for at least 1 hour before flying the model. In areas where

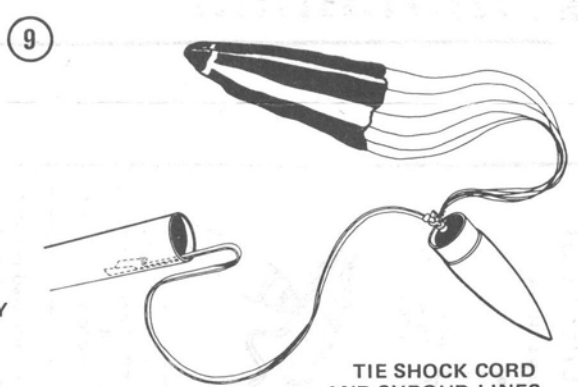

TIE SHOCK CORD AND SHROUD LINES TO SCREW EYE

the humidity is high, allow several hours for the glue to dry.)
NOTE: If a fin should become warped it may be easily straightened. Bend it in the direction opposite the warp and hold it in that position for a few seconds. Repeat as needed until the fin is straight.

COUNTDOWN CHECKLIST

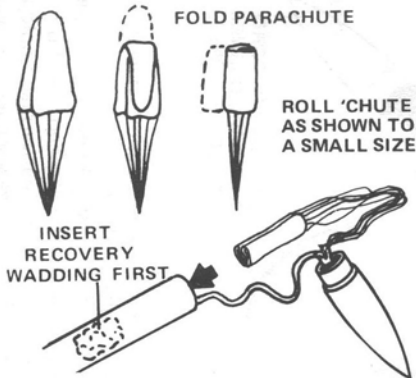

NOTE: DO NOT pack parachute until you are actually ready to launch. For maximum parachute reliability, lightly dust 'chute with ordinary talcum powder, especially in cold weather.

T-13 Pack flameproof recovery wadding into the body tube from the top. Fill the tube for a distance of 1-1/2", sealing along the sides of the tube. Hold the parachute at its center and pass the other hand down it to form a "spike" shape. Fold this spike into halves and pack into the tube on top of the wadding. Pack the shroud lines and shock cord in on top of the parachute and slip the nose cone into place.

T-12 Select an engine. Use an Estes A8-3 for the first flight. Estes 1/2A6-2, A8-3, B4-4, B6-4, or C6-5 engines may be used for later flights.

T-11 Insert the engine fully into the engine holder tube, springing the engine holder up enough to admit the front of the engine.

T-10 Remove the safety interlock key from the launch control panel. (If a simple spring switch is used, install the protector around the spring.) Carry the key or interlock on the person of the launch control officer.

T-9 Place the rocket on the launcher. Check to be sure the panel is disarmed. Clean the micro-clips and attach them to the igniter.

T-8 Clear the launch area, alert the recovery crew and trackers.

T-7 Check for low flying aircraft and unauthorized persons in recovery area.

T-6 Arm the launch panel.

T-5-4-3-2-1 LAUNCH!!

Be sure to follow the *HIAA-NAR Model Rocketry Safety Code when carrying out your model rocket activities.

*HIAA-NAR - Hobby Industry Association of America
National Association of Rocketry

MESSAGE TO NEW ROCKETEERS

Your Alpha III features a plastic nose cone and fin unit for ease in construction. The Estes Research and Development Division has combined a high performance design with lightweight materials and simple assembly techniques to introduce a beginner's rocket that is both fun to build and exciting to fly. After launching your Alpha III, construct and fly a second single stage rocket like the X-Ray, Sky Hook, or Big Bertha to gain experience in balsa wood construction and finishing. Your two kits will teach you the basic principles of model rocket technology and provide you with a knowledgeable background for advancement to multi-stage, boost-glider, and scale type model rockets.

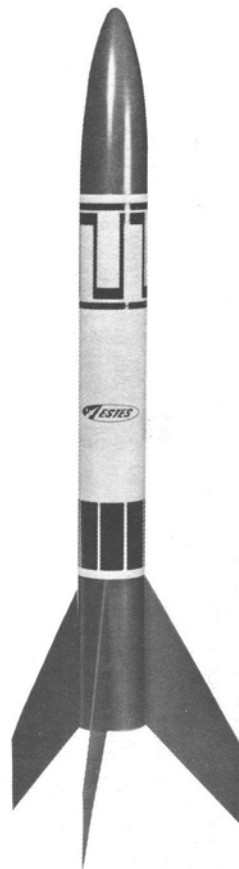

RULER

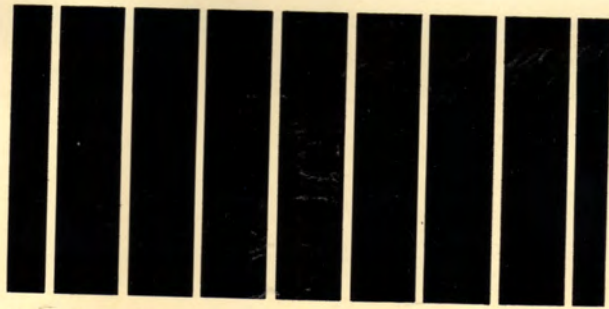

1 2 3 4 5 6 7 8 9 0

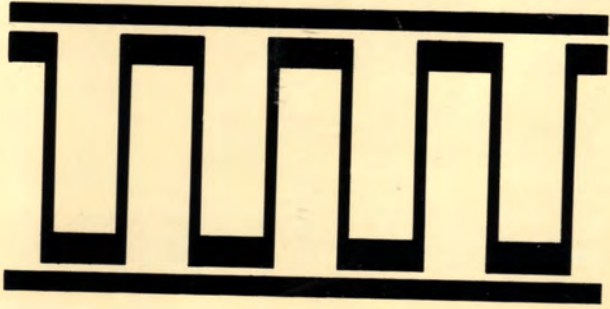

U S A U S A
U S A U S A
U S A U S A

ESTES
INDUSTRIES
PN 37014

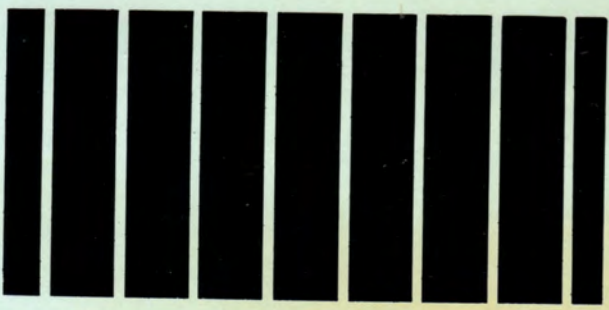

1 2 3 4 5 6 7 8 9 0

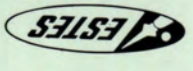
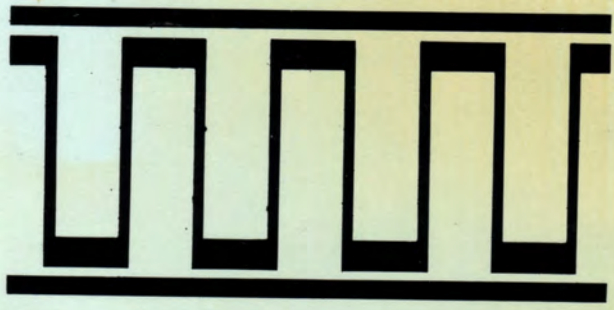

U S A U S A
U S A U S A
U S A U S A

ESTES
INDUSTRIES,
INC. D-14
37014