

FREAKY FLYER™

▶ **FLIES TO 700 FT.
(213 M)!**

▶ **NO PAINTING
REQUIRED!**

▶ **STREAMER
RECOVERY!**



Length: 5.38 in.
(13.7 cm)

Diameter: 0.76 in.
(19.1 mm)

Weight: 0.67 oz.
(18.9 g)

Recovery:
Streamer

Recommended

Engines:
1/4A3-3T, 1/2A3-4T,
A3-4T, (First Flight)
A10-3T

ESTES INDUSTRIES
1285 H Street
Peacock, CO 81240

Made in China

EST 1203



0 47776 01203 5

1 MODÈLE RÉDUIT
COLLE
NON COMPRIS



www.estesrockets.com

Estes Industries
1295 H Street
Penrose, CO 81240
Printed in China

FREAKY FLYER™

FLYING MODEL ROCKET KIT

KEEP FOR FUTURE REFERENCE

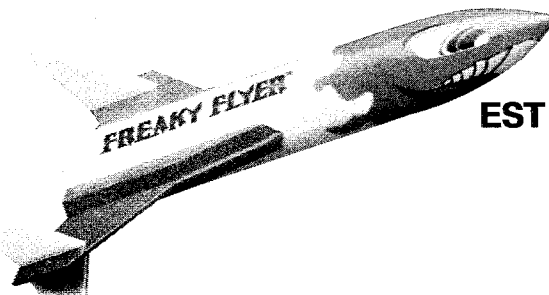

EST 1203

ASSEMBLY TIP

Read all instructions before beginning work on your model. Make sure you have all parts and supplies.

TEST-FIT ALL PARTS TOGETHER BEFORE APPLYING ANY GLUE. If any parts don't fit properly, sand as required for precision assembly.

PARTS

Locate the parts shown below and lay them out on the table in front of you. **DO NOT USE THIS DRAWING TO ASSEMBLE YOUR ROCKET.**

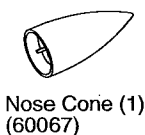
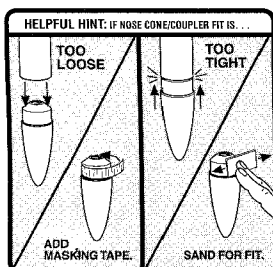

Nose Cone (1)
(60067)



Nose Cone Insert (1)
(60068)

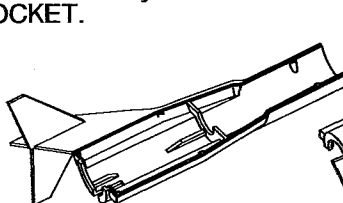

Body Half A (1)
(60069)

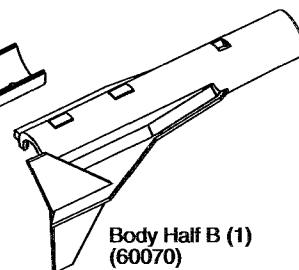

Body Half B (1)
(60070)

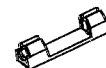

Launch Lug (1)
(60071)



Clay (1)
85704)



Shock Cord (1)
(38373)

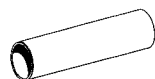

Engine Mount Tube (1)
(31174)



Retainer Ring (1)
(30167)



Engine Hook (1)
(35023)

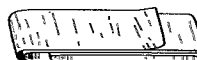

Streamer (1)
(60034)



Decal Sheet (1)
(60072)

SUPPLIES

In addition to the parts included in the kit you will also need:



PLASTIC CEMENT



CARPENTER'S GLUE



MODELING KNIFE



PENCIL



FINE SAND PAPER
(#400-600 GRIT)



RULER



MASKING TAPE

1. A.

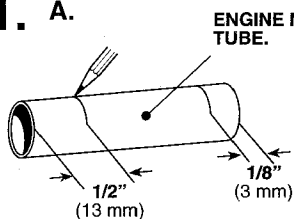

ENGINE MOUNT TUBE.

B.

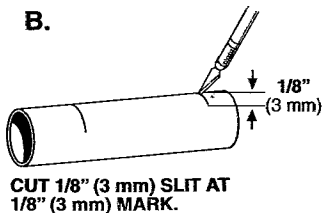

CUT 1/8" (3 mm) SLIT AT 1/8" (3 mm) MARK.

C. POSITION HOOK.

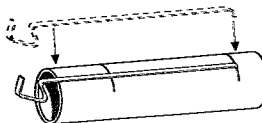

D. APPLY GLUE BAND AROUND TUBE ABOVE 1/2" (13 mm) MARK.

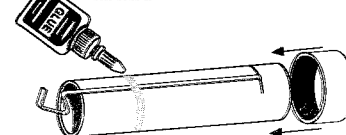

E. SLIDE RETAINER RING ONTO GLUE BAND DOWN TO MARK.

2. A. DROP CLAY INTO NOSE CONE.



B. PACK CLAY.

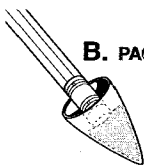

C. APPLY PLASTIC CEMENT.



D. INSERT

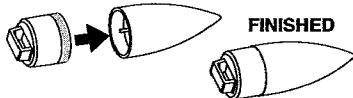

FINISHED

3. A. SHOCK CORD

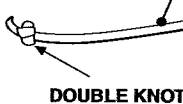

B. PASS SHOCK CORD THROUGH SHOCK CORD MOUNT UNTIL KNOT IS AGAINST SHOCK CORD MOUNT.

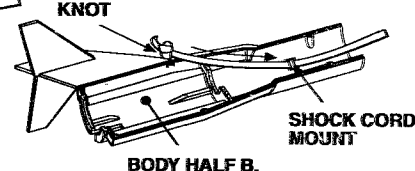

C. TIE SHOCK CORD TO NOSE CONE.



4.

A. ALIGN ENGINE HOOK WITH REAR SLOT IN BODY HALF A AND PLACE ENGINE MOUNT INSIDE.

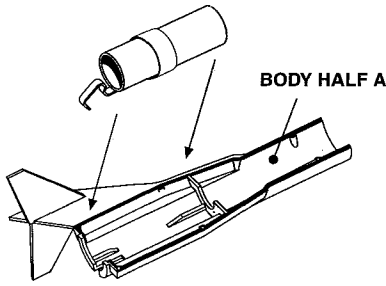

B. APPLY PLASTIC CEMENT TO BODY HALF B.

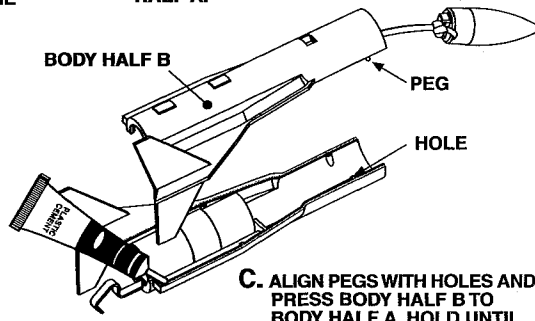

D. APPLY PLASTIC CEMENT

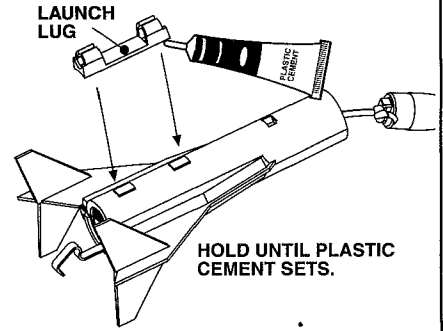

C. ALIGN PEGS WITH HOLES AND PRESS BODY HALF B TO BODY HALF A. HOLD UNTIL PLASTIC CEMENT SETS.

HOLD UNTIL PLASTIC CEMENT SETS.

**FINISH YOUR ROCKET
USE PACKAGE PANEL FOR DECAL PLACEMENT**

ROCKET PREFLIGHT

A. TIE STREAMER TO SHOCKCORD.

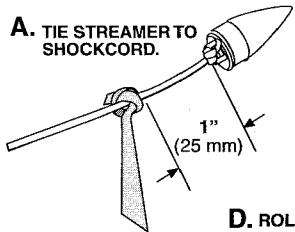

B. INSERT 1/4 LOOSELY CRUMPLED SQUARE OF RECOVERY WADDING.

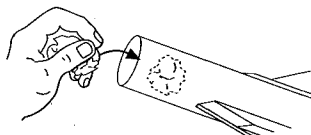

C. FOLD STREAMER

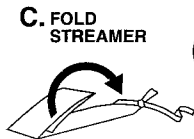

D. ROLL

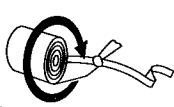

E. WRAP SHOCKCORD LOOSELY, INSERT STREAMER, SHOCKCORD AND NOSE CONE.

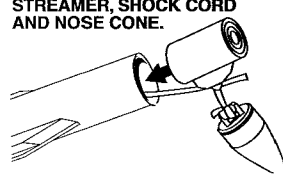

ENGINE PREP

WARNING: FLAMMABLE
Before proceeding read instructions & NAR Safety Code included with engines.

PREPARE YOUR ENGINE ONLY WHEN YOU ARE OUTSIDE AT THE LAUNCH SITE PREPARING TO LAUNCH!
If you do not use your prepared engine, remove the igniter before storing your engine.

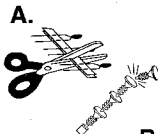

B. TIP MUST TOUCH PROPELLANT.

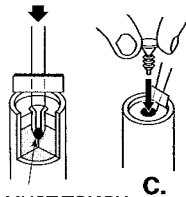

C.

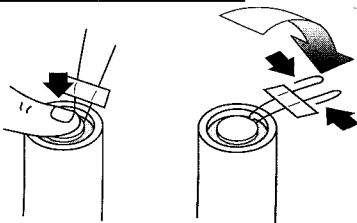

D.

E.

F. INSERT ENGINE.

COUNTDOWN AND LAUNCH

LAUNCH SUPPLIES

- (Sold Separately)
- Estes® Porta Pad® II Launch Pad and Electron Beam® Controller
- Recovery Wadding
- Igniters (with Engines)
- Igniter Plugs (with Engines)
- Estes® Engines:
1/4A3-3T, 1/2A3-4T, A3-4T (First Flight)
A10-3T

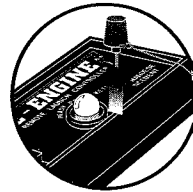

KEY ALWAYS OUT UNTIL FINAL COUNTDOWN!

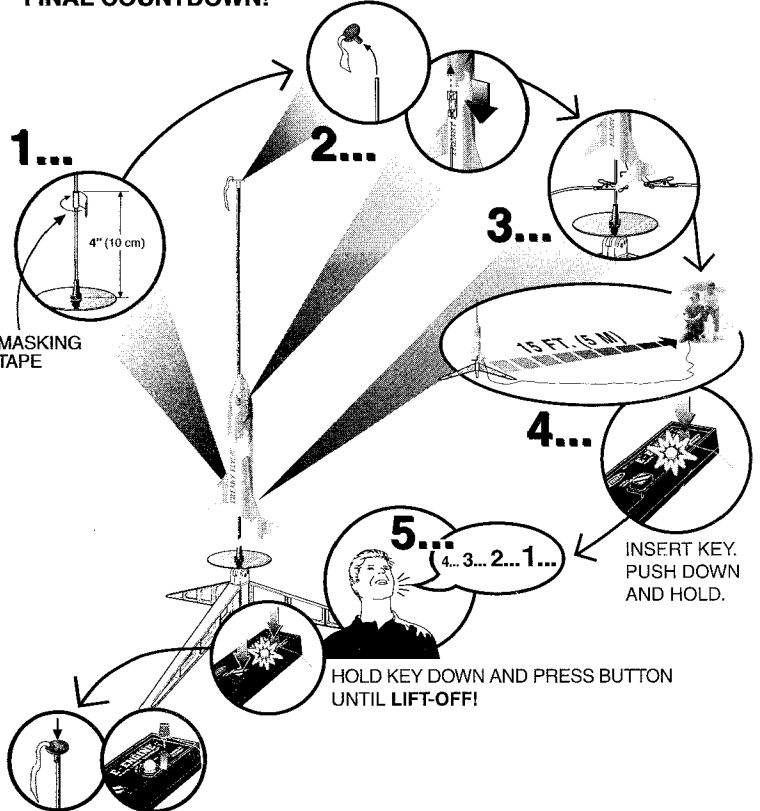

PRECAUTIONS

NAR Safety Code

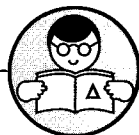

NO DRY GRASS OR WEEDS

FLYING YOUR ROCKET

Choose a large field (250 ft. [76 m] square) free of dry weeds and brown grass. The larger the launch area, the better your chance of recovering your rocket. Football fields and playgrounds are great. Launch only with little or no wind and good visibility.

Always follow the National Association of Rocketry (NAR) SAFETY CODE.

MISFIRES

TAKE THE KEY OUT OF THE CONTROLLER. WAIT ONE MINUTE BEFORE GOING NEAR THE ROCKET! Take the plug and igniter out of the engine. If the igniter has burned, it worked but did not ignite the engine because it was not touching the propellant inside the engine. Put a new igniter all the way inside the engine without bending it. Push the plug in place. Repeat the steps under Countdown and Launch.

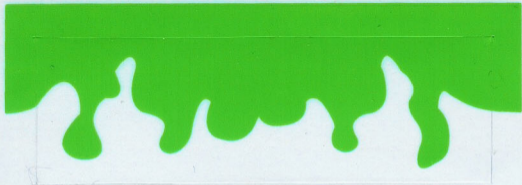

FREAKY FLYER™

FREAKY FLYER™ DECAL. PRINTED IN CHINA
© 2001 Centuri Corp. All rights reserved. (10/01)

