

# FLYING MODEL

# ROCKET™

SKILL LEVEL E2K®

## BANDITO™

- ▶ Build and Launch in 1 Hour!
- ▶ No Painting!
- ▶ Mini Engine Power!
- ▶ Flies to 600 Ft. (183 m)

**HIGH  
PERFORMANCE  
3-FIN DESIGN!**

Assembly required.  
Gluo, finishing supplies and launch  
supplies - not included.

1 MODÈL RÉDUIT.  
COLLE NON COMPRIS.

Great for  
Scouts, Clubs  
or Schools!



Call 1-800-63-SPACE  
Reference ESR03, or Visit  
[www.spacecamp.com](http://www.spacecamp.com)

[www.estesrockets.com](http://www.estesrockets.com)

Made in China



© 2003 Estes-Cox Corp. All rights reserved.  
PN 60604 (09-03)

CUT ALONG DOTTED LINE - KEEP FOR FUTURE REFERENCE

Length:  
11.2 in. (28.4 cm)  
Diameter:  
0.736 in. (18.7 mm)  
Weight:  
0.60 oz. (17 grams)  
Altitude:  
600 ft. (183 m)

Recovery:  
Parachute  
12 in. (30 cm)

Engines:  
I4R3-3T, I2R3-2T,  
R3-4T, R10-3T

**BANDITO™**  
FLYING MODEL ROCKET



www.estesrockets.com

ESTES INDUSTRIES  
1295 H Street  
Penrose, CO 81240  
PRINTED IN CHINA

# BANDITO™

0803

## FLYING MODEL ROCKET KIT INSTRUCTIONS

KEEP FOR FUTURE REFERENCE

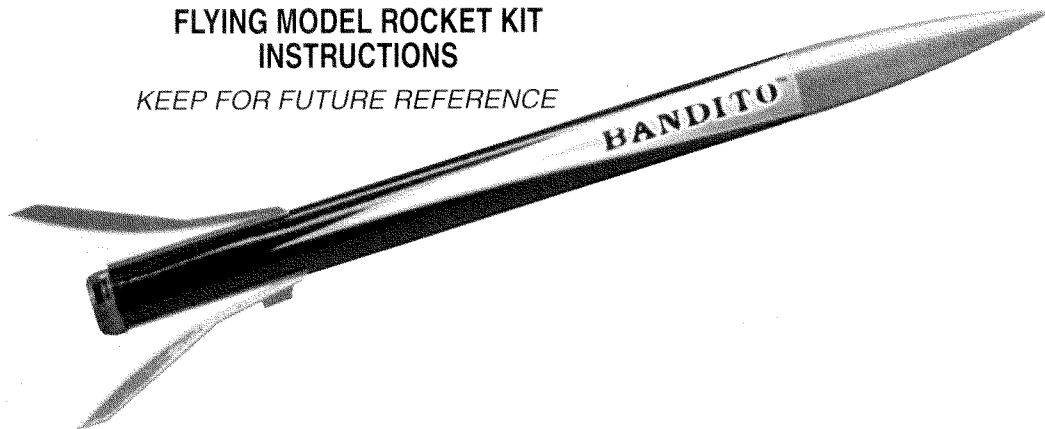

**ASSEMBLY TIP:** Read all instructions before beginning work on your model. Make sure you have all parts and supplies.

### TEST-FIT ALL PARTS TOGETHER BEFORE APPLYING ANY GLUE!

If any parts don't fit properly, sand as required for precision assembly.

### PARTS:

Locate the parts shown below and lay them out on the table in front of you. DO NOT USE THIS DRAWING TO ASSEMBLE YOUR ROCKET.

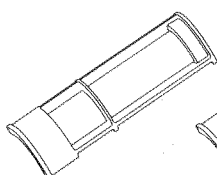
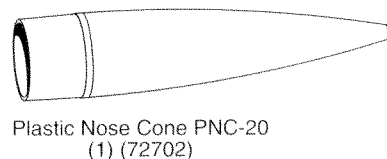
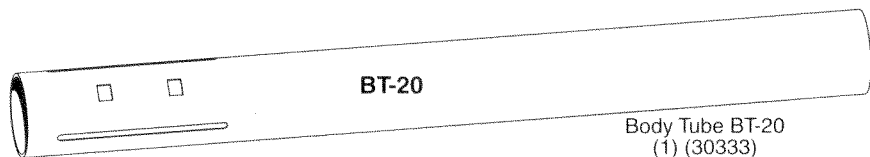

Plastic Frame A  
(1) (60598)

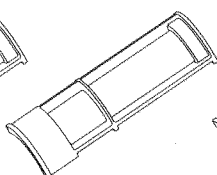

Plastic Frame B  
(1) (60599)

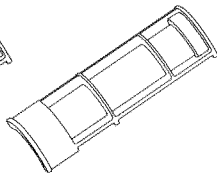

Plastic Frame C  
(1) (60600)

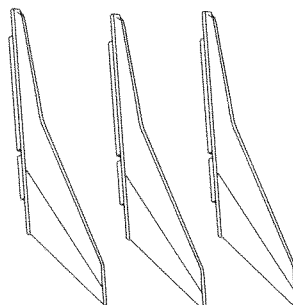

Plastic Fin Style A  
(3) (60602)



Plastic Nose Cone Insert PIN-20  
(1) (72603)



Plastic Upper Ring  
(1) (60597)



Plastic Lower Ring A  
(1) (60595)



Plastic Lower Ring B  
(1) (60596)

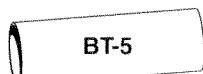

Engine Mount Tube BT-5  
(1) (30309)

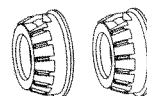

Plastic Engine Cap  
(2) (60594)



Shock Cord (1)  
1/8" x 12"  
(38373)

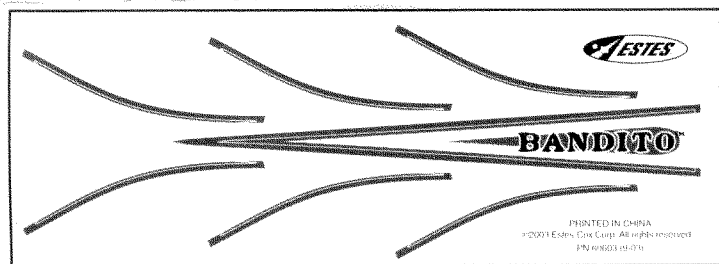

Decal Sheet (1) (60603)

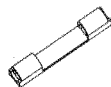

Plastic Launch Lug  
(1) (60601)

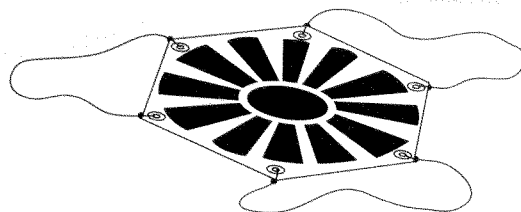

Assembled 12" (30 cm)  
Parachute  
(1) (35801)

### SUPPLIES

In addition to the parts included in the kit you will also need:



SCISSORS



PLASTIC CEMENT



CARPENTER'S GLUE

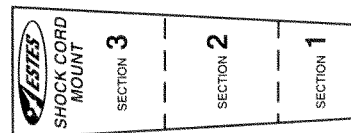
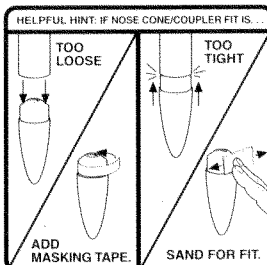

# 1. ASSEMBLE ENGINE MOUNT

A. Apply plastic cement to Lower Ring B then insert Lower Ring A. Let Dry.

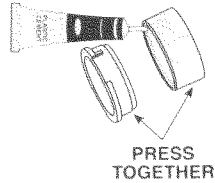

COMPLETED ASSEMBLY

B. Apply plastic cement inside plastic assembly. Insert engine mount tube until it stops. Let Dry.

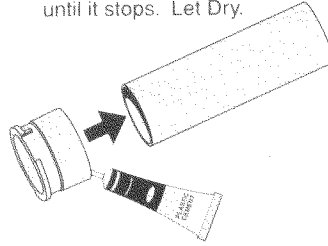

C. Apply plastic cement inside front of Engine Mount Tube. Insert Upper Ring. Let Dry.

REAR

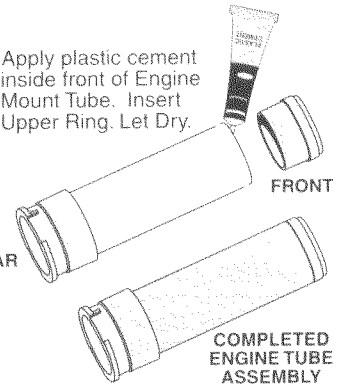

D. Apply plastic cement to Engine Mount Frame C. Attach to Engine Mount Tube. Let Dry.

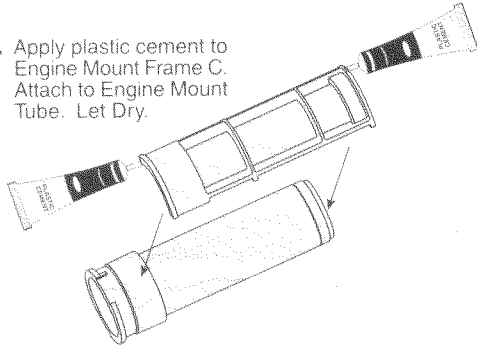

E. Glue remaining Engine Mount Frames A&B to Engine Mount Tube. Let Dry.

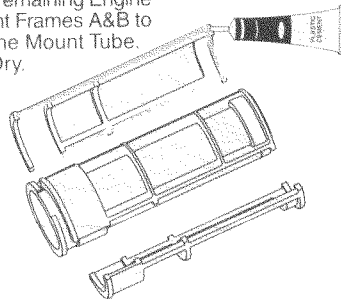

COMPLETED ENGINE MOUNT ASSEMBLY

# 2. INSTALL ENGINE MOUNT

A. Apply plastic cement inside rear of slotted Body Tube.

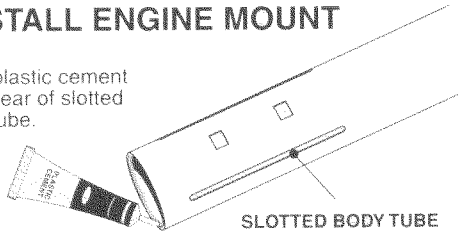

B. Align fin slots with openings. Insert Engine Mount. Let Dry.

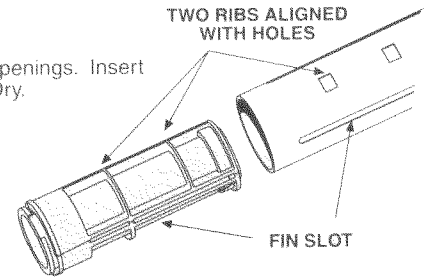

# 3. ATTACH FINS

A. Apply plastic cement to tabs on fin and insert fin into fin slot. Let Dry.

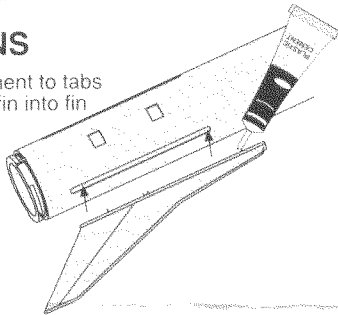

B. Repeat for remaining Fins. Let Dry.

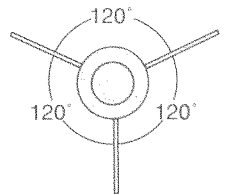
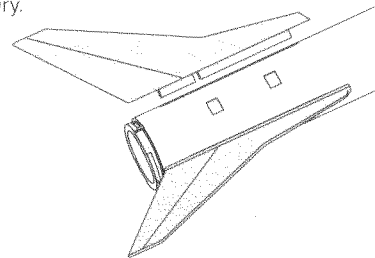

NOTE: FINS MUST BE ATTACHED CORRECTLY FOR STABLE FLIGHT.

# 4. ATTACH LAUNCH LUGS

A. Apply plastic cement to tabs on Launch Lug. Attach to mounting holes on Body Tube. Let Dry.

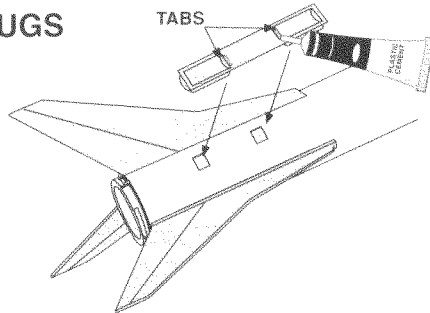

B. When completely dry, twist Engine Cap clockwise onto end of Engine Mount.

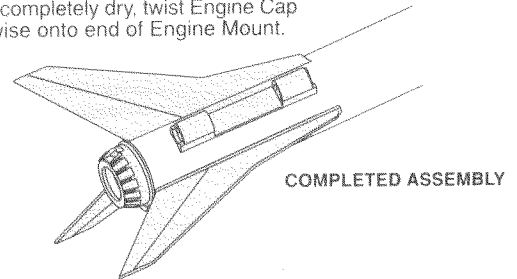

# 5. ASSEMBLE NOSE CONE

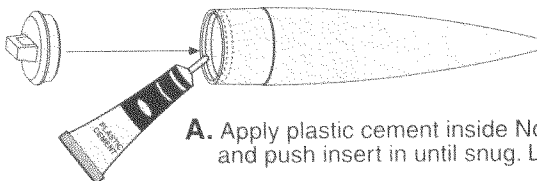

A. Apply plastic cement inside Nose Cone and push insert in until snug. Let dry.

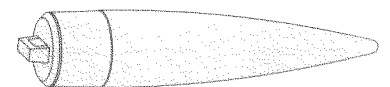

COMPLETED NOSE CONE

## 6. ATTACH SHOCK CORD

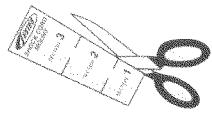

**A.** Cut out Shock Cord Mount from FRONT PAGE.

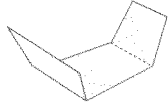

**B.** Crease

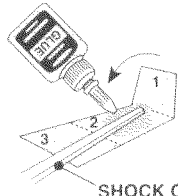

**C.** Apply glue. Fold forward.

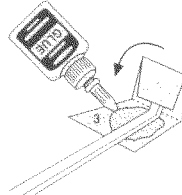

**D.** Apply glue. Fold forward.

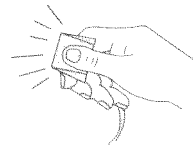

**E.** Squeeze tightly and hold for one minute.

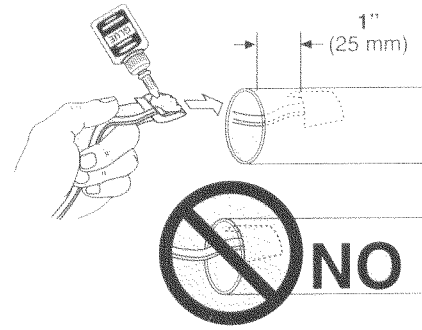

**F.** Glue mount at least 1" (25 mm) inside front of Body Tube. Hold until glue sets. Let Dry.

## 7. ATTACH PARACHUTE AND SHOCK CORD

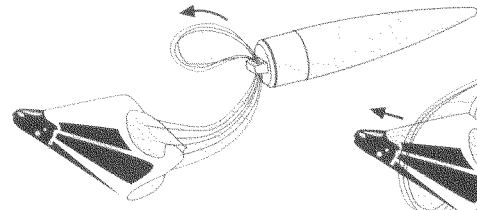

**A.** Form loop in Shroud Lines and push through hole in Nose Cone.

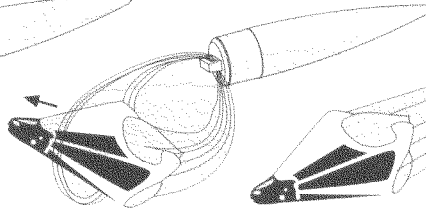

**B.** Pass 'Chute through loop.

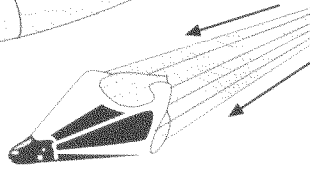

**C.** Pull tight.

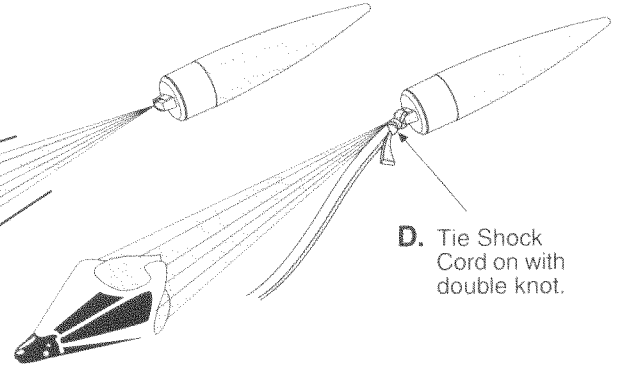

**D.** Tie Shock Cord on with double knot.

## 8. APPLY DECALS

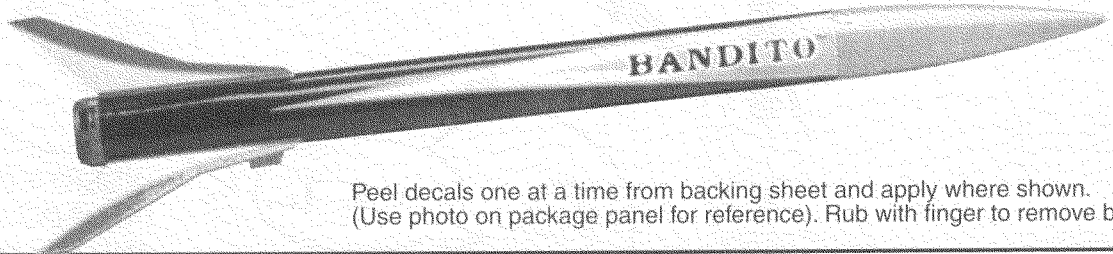

Peel decals one at a time from backing sheet and apply where shown. (Use photo on package panel for reference). Rub with finger to remove bubbles.

## PREPARE PARACHUTE FOR FLIGHT

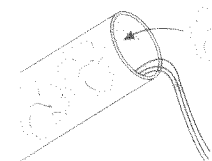

**A.** Insert 2-3 squares of loosely crumpled recovery wadding into rocket.

**NOTE:** Only Estes Wadding (EST 302274) Recommended.

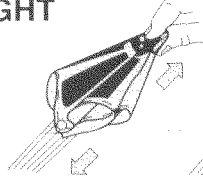

**B.** Spike.



**C.** Fold.

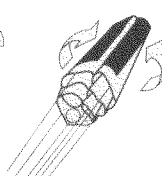

**D.** Roll.

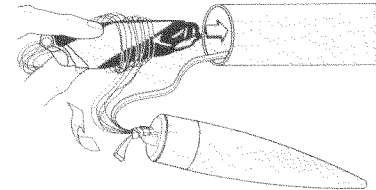

**E.** Wrap lines loosely. Insert 'Chute, Shock Cord and Nose Cone into Body Tube.

## PREPARE ENGINE

**WARNING: FLAMMABLE**  
To avoid serious injury, read instructions & NAR Safety Code included with engines.  
**PREPARE YOUR ENGINE ONLY WHEN YOU ARE OUTSIDE AT THE LAUNCH SITE PREPARING TO LAUNCH!**  
If you do not use your prepared engine, remove the igniter before storing your engine.

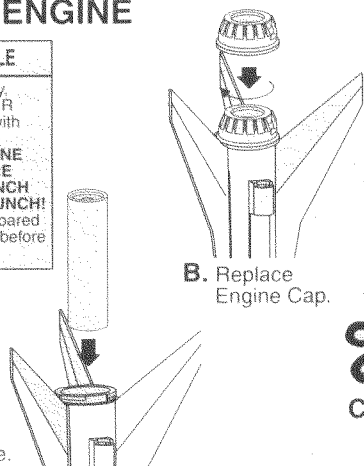

**A.** Remove Engine Cap. Insert engine.

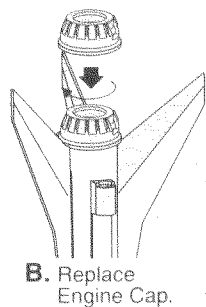

**B.** Replace Engine Cap.

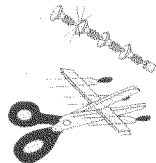

**C.** Separate Igniter and Plug.

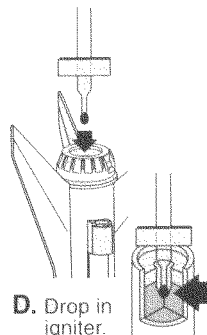

**D.** Drop in igniter.

**TIP MUST TOUCH PROPELLANT!**

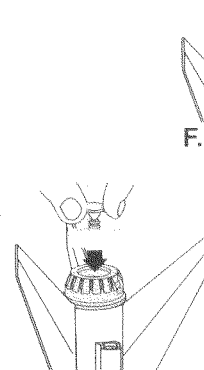

**E.** Insert Igniter Plug.

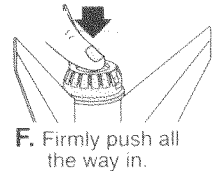

**F.** Firmly push all the way in.

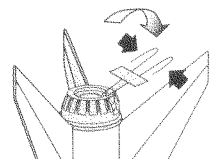

**G.** Bend Igniter Wires back as shown.

# COUNTDOWN AND LAUNCH

## LAUNCH SUPPLIES (Sold Separately)

- Porta Pad® II Launch Pad
- Electron Beam® Launch Controller
- Recovery Wadding
- Igniters (with Engines)
- Igniter Plugs (with Engines)
- Recommended Estes® Engines:  
1/4A3-3T, 1/2A3-2T, A3-4T, A10-3T

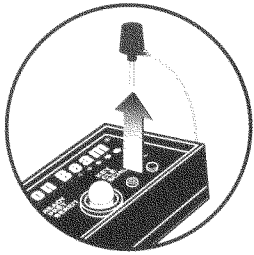

KEY ALWAYS OUT UNTIL FINAL COUNTDOWN!

SLIDE ROCKET DOWN OVER LAUNCH ROD.

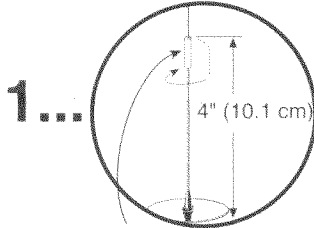
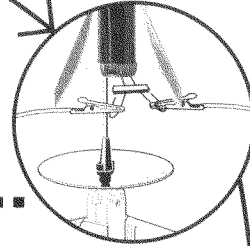
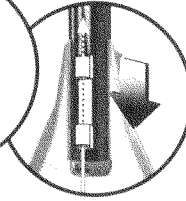
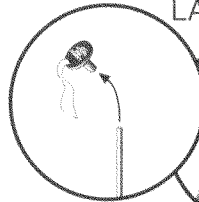

Masking Tape

3...



4...

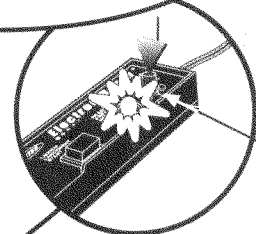

KEY

INSERT KEY. PUSH DOWN AND HOLD.

5...

4... 3... 2... 1...



HOLD KEY DOWN AND PRESS LAUNCH BUTTON UNTIL LIFT-OFF!

LAUNCH BUTTON

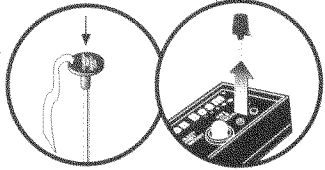

## PRECAUTIONS

NAR Safety Code

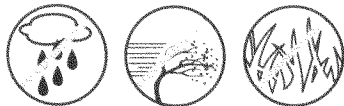

NO DRY GRASS OR WEEDS

## FLYING YOUR ROCKET

Choose a large field (500 ft. [152 m] square) free of dry weeds and brown grass. The larger the launch area, the better your chance of recovering your rocket. Football fields and playgrounds are great. Launch only with little or no wind and good visibility.

Always follow the National Association of Rocketry (NAR) Safety Code.

## MISFIRES

**TAKE THE KEY OUT OF THE CONTROLLER. WAIT ONE MINUTE BEFORE GOING NEAR THE ROCKET!** Disconnect the igniter clips and remove the engine. Take the plug and igniter out of the engine. If the igniter has burned, it worked but did not ignite the engine because it was not touching the propellant inside the engine. Put a new igniter all the way inside the engine without bending it. Push the plug in place. Repeat the steps under Countdown and Launch.

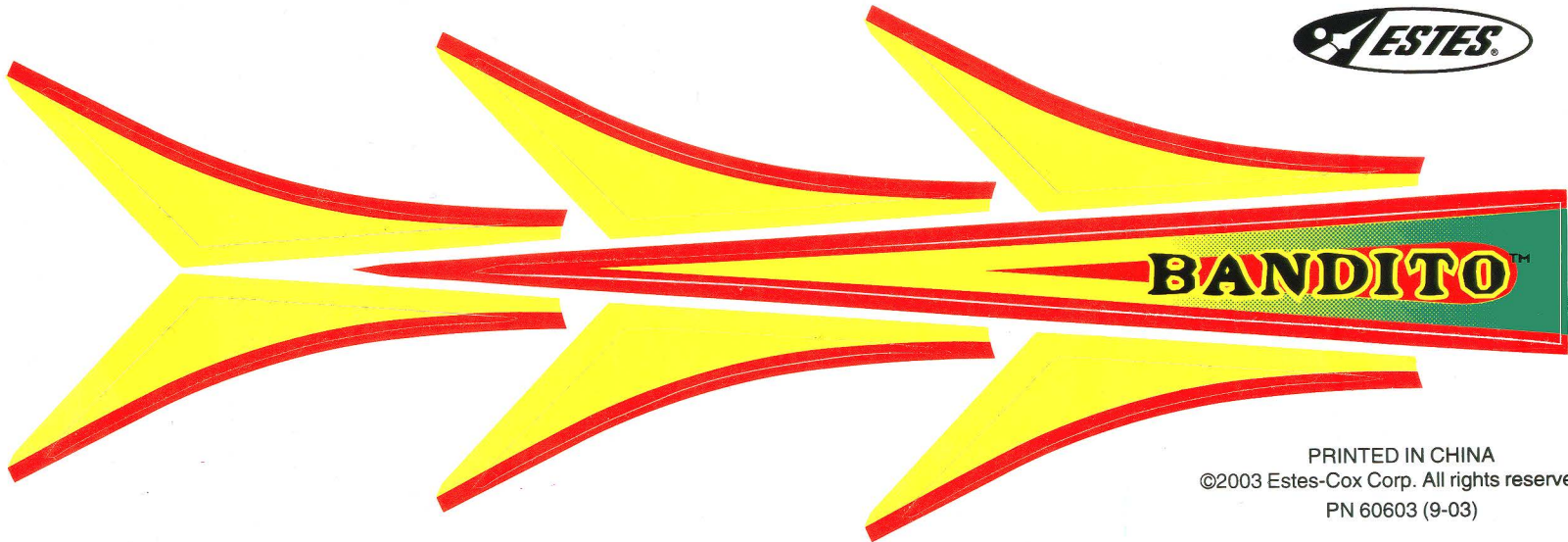

PRINTED IN CHINA  
©2003 Estes-Cox Corp. All rights reserved.  
PN 60603 (9-03)