

Make a Custom Nose Cone

Read the discussion of the Metrix System on the previous page. Look how simple it is to make a custom nose cone using the Telescoping Tubing.

1.

Draw your design to scale on a piece of medium weight cardboard.

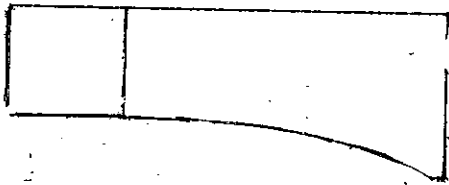
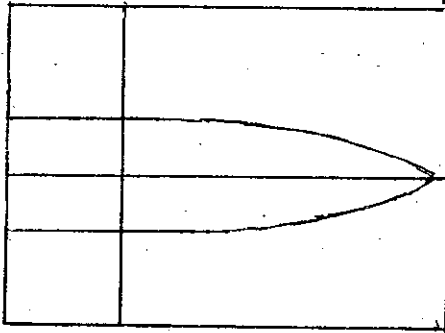

2.

Cut out the "template" so that you have a form guide.

3.

Insert second largest tube into the largest and adjust to template as in diagram. Mark with pencil as shown.

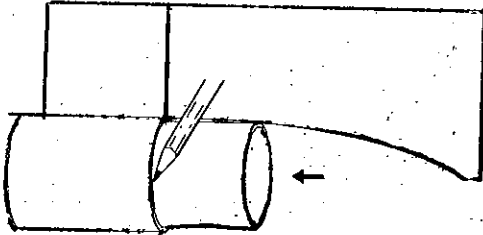

4.

Without gluing any of the members, repeat step 3 until all members conform to the template. Then, in order, glue each section in place using the pencil marks and template both as guides.

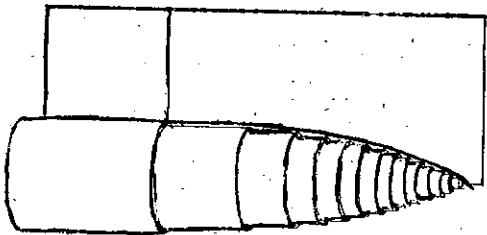

5.

Glue a short section of primary tubing on the exterior of the largest tube to form tenon.

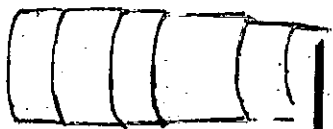

6.

Apply the special molding compound and allow to dry. Sand to obtain a smooth surface for final finishing.

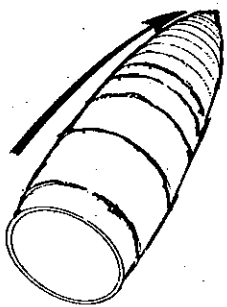

(This system is being released gradually. Products listed are not all available at this time. If you order tubing that is unavailable you will receive a credit slip for that portion of your order.)

METRIX TUBING

PRIMARY

This series of tubing is available in sizes that have Outside Diameters in even increments of 5MM. The wall thickness is 0.5MM and thus the Inside Diameters are 1MM less than the OD's.

Tubing sizes available now in standard lengths as indicated.

See page 13 for additional lengths available in various diameters.

Cat. No.	OD (MM)	ID (MM)	od (inches)	id (inches)	Length (cm)	Length (inches)	Price Each
11-10X20	10	9	0.393	0.354	20	8	\$0.10
11-15X20	15	14	0.590	0.551	20	8	0.15
11-20X30	20	19	0.787	0.748	30	12	0.15
11-25X30	25	24	0.984	0.945	30	12	0.25
11-30X30	30	29	1.181	1.142	30	12	0.35
11-35X40	35	34	1.378	1.338	40	16	0.50
11-40X40	40	39	1.575	1.535	40	16	0.55
11-45X40	45	44	1.772	1.732	40	16	0.65
11-50X40	50	49	1.969	1.929	40	16	0.70
11-55X40	55	54	2.165	2.126	40	16	0.80
11-60X40	60	59	2.362	2.323	40	16	0.85

The following tubing is not available at this time but will be added to the line in a later catalog. DO NOT ORDER NOW.

11-65X40	65	64	2.559	2.520	40	16	1.00
11-70X40	70	69	2.756	2.717	40	16	1.05
11-75X40	75	74	2.953	2.914	40	16	1.10
11-80X40	80	79	3.150	3.111	40	16	1.15
11-85X40	85	84	3.347	3.307	40	16	1.20
11-90X40	90	89	3.544	3.504	40	16	1.25
11-95X40	95	94	3.741	3.701	40	16	1.30
11-100X40	100	99	3.938	3.898	40	16	1.45

SECONDARY

The secondary tubing series is designed to slip-fit into the primary series. Thus for each primary series tube size there is a primary tube size that has an OD that is 1 MM less than the primary it fits into. The Wall thickness on the secondary tubing is also 0.5 MM and thus the ID of the secondary series is 1 MM less than its OD.

Cat. No.	OD (MM)	ID (MM)	od (inches)	id (inches)	Approx Length (cm)	Length (inches)	Price Each
12-08X02	9	8	0.354	0.315	2	0.750	\$0.10
12-14X02	14	13	0.551	0.511	2	0.750	0.10
12-19X02	19	18	0.748	0.708	2	0.750	0.10
12-24X03	24	23	0.945	0.905	3	1.250	0.10
12-29X03	29	28	1.142	1.102	3	1.250	0.10
12-34X04	34	33	1.338	1.298	4	1.575	0.15
12-39X04	39	38	1.535	1.496	4	1.575	0.15
12-44X05	44	43	1.732	1.693	5	1.969	0.15
12-49X05	49	48	1.929	1.890	5	1.969	0.20
12-54X06	54	53	2.126	2.087	6	2.363	0.20
12-59X06	59	58	2.323	2.284	6	2.363	0.25

The following tubing is not available at this time but will be added to the line in a later catalog. DO NOT ORDER NOW.

12-64X07	64	63	2.520	2.480	7	2.757	0.25
12-69X07	69	68	2.717	2.677	7	2.757	0.25
12-74X08	74	73	2.914	2.874	8	3.150	0.30
12-79X08	79	78	3.111	3.071	8	3.150	0.30
12-84X09	84	83	3.307	3.268	9	3.544	0.30
12-89X09	89	88	3.504	3.465	9	3.544	0.35
12-94X10	94	93	3.701	3.662	10	3.938	0.35
12-99X10	99	98	3.898	3.859	10	3.938	0.35

TELESCOPING

The patent applied for Metrix construction tubing gives the modeler the greatest flexibility in design creativity. The OD of each size will snug-fit into a primary tubing size. That same telescoping tube will fit in the next large telescoping tubing snugly, as the later will in the next larger size on up through the whole series.

Here are the specifications on the individual T Tubing sizes ...

Cat. No.	OD (MM)	ID (MM)	od (inches)	id (inches)	Length (cm)	Length (inches)	Color	Price Each
16-09T01	9	4	0.354	0.157	1	0.394	Red	\$0.10
16-14T02	14	9	0.551	0.354	2	0.787	Orange	0.10
16-19T02	19	14	0.748	0.551	2	0.787	Yellow	0.10
16-24T03	24	19	0.945	0.748	3	1.181	Green	0.10
16-29T03	29	24	1.142	0.945	3	1.181	Blue	0.10
16-34T04	34	29	1.338	1.142	4	1.575	Red	0.10
16-39T04	39	34	1.535	1.338	4	1.575	Orange	0.15
16-44T05	44	39	1.732	1.535	5	1.969	Yellow	0.15
16-49T05	49	44	1.929	1.732	5	1.969	Green	0.15
16-54T06	54	49	2.126	1.929	6	2.362	Blue	0.15
16-59T06	59	54	2.323	2.126	6	2.362	Red	0.20
16-5904S	One each of the above telescoping tubing. (Save \$4.00)							1.00

The following tubing is not available at this time but will be added to the line in a later catalog. DO NOT ORDER NOW!

16-64T07	64	59	2.520	2.323	7	2.756	Orange	0.20
16-69T07	69	64	2.717	2.520	7	2.756	Yellow	0.20
16-74T08	74	69	2.914	2.717	8	3.150	Green	0.25
16-79T08	79	74	3.111	2.914	8	3.150	Blue	0.25
16-84T09	84	79	3.307	3.111	9	3.544	Red	0.25
16-89T09	89	84	3.504	3.307	9	3.544	Orange	0.30
16-94T10	94	89	3.701	3.504	10	3.938	Yellow	0.30
16-99T10	99	94	3.898	3.701	10	3.938	Green	0.40
16-9959S	One each of second set. (Save \$5.00)							1.65

Thus for \$2.65 you can build a nose cone to fit a 100MM tube (4 inch Diameter) by buying both of the above sets.

STRUCTURAL RINGS

This set of rings will nest each succeeding smaller size in the previous. They have the same OD's and ID's as the Telescoping Tubing series and the same color coding. Each ring size will snug fit into the next larger Primary Tubing.

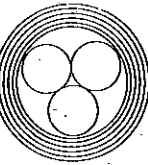

Nesting Rings have the following specifications ...

Cat. No.	OD (MM)	ID (MM)	od (inches)	id (inches)	Length (cm)	Length (inches)	Color	Price Each
19-09R04	9	4	0.354	0.157	1	0.393	Red	\$0.10
19-14R09	14	9	0.551	0.354	1	0.393	Orange	0.10
19-19R14	19	14	0.748	0.551	1	0.393	Yellow	0.10
19-24R19	24	19	0.945	0.748	1	0.393	Green	0.10
19-29R21	29	24	1.142	0.945	1	0.393	Blue	0.10
19-34R29	34	29	1.338	1.142	1	0.393	Red	0.10
19-39R34	39	34	1.535	1.338	1	0.393	Orange	0.10
19-44R39	44	39	1.732	1.535	1	0.393	Yellow	0.10
19-49R44	49	44	1.929	1.732	1	0.393	Green	0.10
19-54R49	54	49	2.126	1.929	1	0.393	Blue	0.10
19-59R54	59	54	2.323	2.126	1	0.393	Red	0.10
19-5904S	One each of the above rings. (Individually \$1.10)							0.70

The following rings are not available at this time but will be added to the line in a later catalog. DO NOT ORDER THESE NOW!

19-64R59	64	59	2.520	2.323	1	0.393	Orange	0.15
19-69R64	69	64	2.717	2.520	1	0.393	Yellow	0.15
19-74R69	74	69	2.914	2.717	1	0.393	Green	0.15
19-79R74	79	74	3.111	2.914	1	0.393	Blue	0.15
19-84R79	84	79	3.307	3.111	1	0.393	Red	0.20
19-89R84	89	84	3.504	3.307	1	0.393	Orange	0.20
19-94R89	94	89	3.701	3.504	1	0.393	Yellow	0.25
19-99R94	99	94	3.898	3.701	1	0.393	Green	0.25
19-9959S	One each of the second set of rings. (Individually \$1.50)							0.90

ADDITIONAL ITEMS

99-9000 Paper Mache Filler Compound - Use this material to fill in on your Metrix System Nose Cones and other structures. Enough material for a dozen or more parts. \$0.50

99-9001 Set of three paper shrouds and transitions for AVI Metrix tubing. One paper transition from T14 to T30 with 17.5 degree angle. One Universal Paper Shroud with 15 degree angle, goes from T14 to T35. One paper transition T20 to T30 with 10 degree angle.

Set of 3 \$0.25

99-9003 End-plugs for Metrix Nose cones Included with every 16-09T01 but handy to have spares.

10 for \$0.25

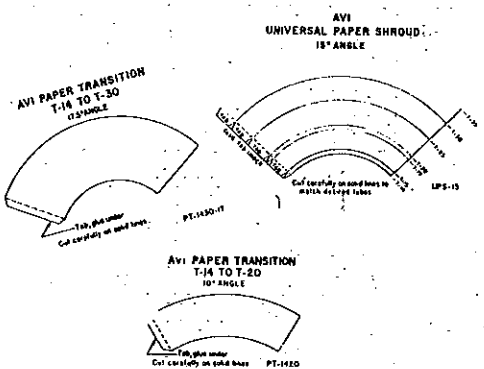

Support Aerospace Education

WE DO

astroport

SPACE MODEL CONSTRUCTION MATERIALS

The scratch builder should have a wide range of materials to choose from. AVI Astroport is always on the search for additional 'raw materials'. Remember that you should not use metal as structural components of flying model rockets. The metal sheets and shapes are for construction of launchers and support facilities, and the fabrication of display models.

Be sure and notify us of any additional materials you think we should add to the line.

BALSA WOOD

The sizes and shapes of balsa available on the market is very broad and we have selected a limited number to list here at this time. This material is available in 36" lengths, but for ease of handling we are making it available in 17 7/8 inch pieces. You must order in packs as indicated. All measurements are given in inches.

Sticks 17 7/8" lengths

3A-1/16s	1/16 x 1/16	30 for \$1.00
3A-1/8 s	1/8 x 1/8	20 for \$1.00
3A-3/32s	3/32 x 3/32	22 for \$1.00
3A-3/16s	3/16 x 3/16	14 for \$1.00
3A-1/4 s	1/4 x 1/4	10 for \$1.00
3A-3/8 s	3/8 x 3/8	5 for \$1.00

Sheets 17 7/8" lengths

3A-1/32 x 3	1/32 x 3	4 for \$1.10
3A-1/16 x 3	1/16 x 3	4 for \$1.20
3A-3/32 x 3	3/32 x 3	4 for \$1.40
3A-1/8 x 3	1/8 x 3	4 for \$1.65
3A-5/32 x 3	5/32 x 3	4 for \$1.90
3A-3/16 x 3	3/16 x 3	4 for \$2.10
3A-1/4 x 3	1/4 x 3	2 for \$1.15
3A-5/16 x 3	5/16 x 3	2 for \$1.35
3A-3/8 x 3	3/8 x 3	2 for \$1.50

Blocks 17 7/8" lengths

1A-1/2+s	1/2+ x 1/2+	4 for \$1.20
1A-1s	1 x 1	4 for \$2.00
1A-1 3/8s	1 3/8 x 1 3/8	2 for \$1.45
1A-2s	2 x 2	1 for \$1.35
1A-3s	3 x 3	1 for \$3.00
1A-OEP	Odds and Ends Package	1 for \$1.00
1A-BOB	Bag-o-Balsa	1 for \$1.50

BONDING AGENTS

There is a wide range of glues available, many single purpose. This listing contains a selection of glues or adhesives that are particularly suited to Model Rocketry demands.

A-AA1

Aron Alpha Cyanoacrylate Monomer. Sets in seconds, cures at room temperature, virtually no shrinkage, no catalyst required.
Blue Cap Tube 2 grams \$2.00
(Caution Cyanoacrylate monomer adhesives adhere readily to skin. Avoid contact with skin and eyes. Provide eye protection, and use with adequate ventilation.)

A-WG1

White Glue Tube 1 oz. \$0.39

A-PCI

Micro Bond Plastic Cement 3/4 oz. tube \$0.29

A-HG1

Hobbsco Goo contact adhesive with rubber base. Recommended for static display models. Still being evaluated by AVI for model rocketry flight hardware. 1 1/8 oz. tube \$0.85

PLYWOOD

High strength specially imported ultrathin plywoods. Aircraft grade for use as fins, structural parts and reinforcing.

-0164	1/64" x 6" x 12"	0.60
-0132	1/32" x 6" x 12"	0.60
-0116	1/16" x 6" x 12"	0.70

METAL

The items listed here are for use in static display models or non-flying models, launch towers, etc. Remember that model rockets cannot contain metal structural parts.

Round Brass Tube 12 inch lengths 1/64" wall thickness

KS-BT01	1/16	\$0.20
KS-BT03	1/8	0.25
KS-BT04	5/32	0.30
KS-BT05	3/16	0.35
KS-BT07	1/4	0.40
KS-BT11	3/8	0.60

Round Aluminum Tube 12 inch lengths 1/64" wall thickness, telescoping

KS-AT01	1/16	0.20
KS-AT02	3/32	0.25
KS-AT03	1/8	0.25
KS-AT04	5/32	0.25
KS-AT05	3/16	0.25
KS-AT06	7/32	0.30
KS-AT07	1/4	0.30
KS-AT08	9/32	0.35

Square Brass Tube 12 inch lengths 1/64" wall thickness, telescoping

KS-ST01	1/16	0.35
KS-ST02	3/32	0.40
KS-ST03	1/8	0.45
KS-ST04	5/32	0.50
KS-ST05	3/16	0.60
KS-ST06	7/32	0.65
KS-ST07	1/4	0.70

Brass Angle 12 inch lengths

KS-BA01	1/8 x 1/8	0.30
KS-BA02	5/32x5/32	0.35
KS-BA03	3/16x3/16	0.45

Brass Channel 12 inch lengths

KS-BC01	1/8	0.40
KS-BC02	5/32	0.45
KS-BC03	3/16	0.50

Sheet Metal 4" x 10" sheets

KS-SM05 Brass	0.60	0.005
KS-SM10 Brass	0.90	0.010
KS-SM16 Al	0.45	0.016
KS-SM32 Al	0.65	0.032
KS-Sm64 Al	0.95	0.064

BASSWOOD STRUCTURAL SHAPES

Partial listing precision milled forms that can be used in scale, fantasy, sport and competition modeling. Minimum order from this category is \$3.00. Standard length of pieces is 22 inches.

Angles

Angle	Each	
NE-501	1/16	0.25
NE-504	1/8	0.30
NE-506	3/16	0.35
NE-507	1/4	0.40
NE-509	3/8	0.60

Tees

NE-511	1/16	0.25
NE-514	1/8	0.30
NE-516	3/16	0.35
NE-517	1/4	0.40
NE-519	3/8	0.60

Channels

NE-540	1/16	0.25
NE-543	1/8	0.30
NE-545	3/16	0.35
NE-546	1/4	0.40
NE-548	3/8	0.60
NE-549	1/2	0.85

Columns

NE-550	1/16	0.25
NE-553	1/8	0.30
NE-555	3/16	0.35
NE-556	1/4	0.40
NE-558	3/8	0.60
NE-559	1/2	0.85

Beams

NE-560	1/16	0.25
NE-563	1/8	0.30
NE-565	3/16	0.35
NE-566	1/4	0.40
NE-568	3/8	0.60
NE-569	1/2	0.85

Stripwood

Stripwood	Each 3" wide	
NE-138	1/32	0.70
NE-195	1/16	0.80
NE-228	3/32	0.95
NE-243	1/8	1.10
NE-270	3/16	1.10
NE-293	1/4	1.20

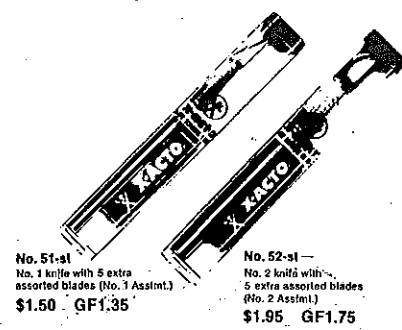

No. 51-1
No. 1 knife with 5 extra assorted blades (No. 1 Assmt.)
\$1.50 GF1.35

No. 52-1
No. 2 knife with 5 extra assorted blades (No. 2 Assmt.)
\$1.95 GF1.75



No. 62-x-acto double knife set
Nos. 1 & 2 knives with 10 ass'd. blades, on plastic base with removable Vizi-Dome cover.
\$3.50 GF3.15



No. 81 x-acto crystal-pak knife set
Nos. 1 & 2 knives with 10 ass'd. extra blades in handy clear plastic case.
\$4.95 GF4.50

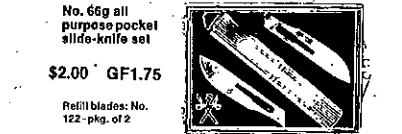

No. 66g all purpose pocket slide-knife set
\$2.00 GF1.75



BLADES: thickness of blade: .005" in body, .010" at cutting edge

No. 34-C \$1.00 GF0.90
X-ACTO RAZOR SAW BLADE - 3/8" wide; cutting edge 4 1/2" long

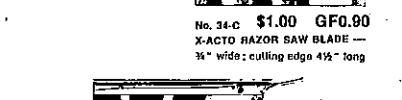

No. 35-C \$1.10 GF1.00
X-ACTO RAZOR SAW BLADE - 1" wide; cutting edge 4 1/2" long

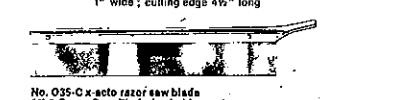

No. 035-C x-acto razor saw blade
1 1/2" Razor Saw Blade for hobby and industrial use. (Cutting Edge 5 1/2" long)
\$1.40 GF1.25

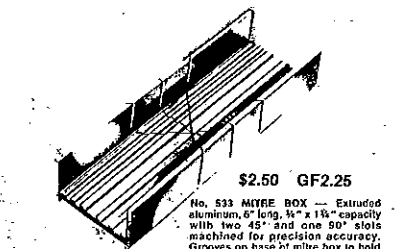

\$2.50 GF2.25
No. 533 MITRE BOX - Extruded aluminum, 6" long, 1/2" x 1 1/2" capacity with two 45° and one 90° slots machined for precision accuracy. Grooves on base of mitre box to hold wood, etc., in sizes: 1/8", 1/4", 3/8", 1/2", 5/8", and 3/4". For use with No. 035-C Saw Blade only.



No. 533-C MITRE BOX SET
Contains aluminum mitre box, No. 035 Razor Saw Blade and No. 5 Handle
\$4.95 GF4.50



No. 4055-2 Razor Saw Set
contains No. 035 Razor Saw Blade and No. 5 Handle. Can also be used with No. 533 Mitre Box.
\$2.50 GF2.25

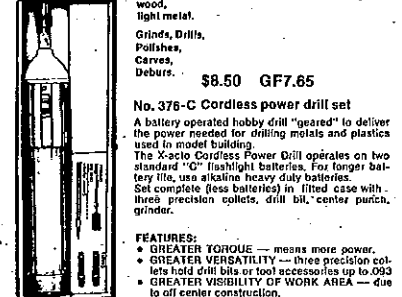

No. 376-C Cordless power drill set
A battery operated hobby drill "geared" to deliver the power needed for drilling metals and plastics used in model building.
The X-acto Cordless Power Drill operates on two standard "C" flashlight batteries. For longer battery life, use alkaline heavy duty batteries.
Set complete (less batteries) in fitted case with three precision collets, drill bit, center punch, grinder.
FEATURES:
• GREATER TORQUE - means more power.
• GREATER VERSATILITY - three precision collets hold drill bits or tool accessories up to .093
• GREATER VISIBILITY OF WORK AREA - due to all center construction.

PLASTIC

Poly-Styrene is a very useful modeling material. It is available in a variety of shapes and also in sheet form. This material is bonded to itself by cements that actually soften the material. Use 'white glues' or Cyanoacrylates for bonding to other materials.

Structural Shapes

(Minimum order is \$3.00)

Angles

PI-A-2	1/16" x 10"	5 for \$1.10
PI-A-4	1/8 " x 15"	4 for \$1.20
PI-A-6	3/16" x 24"	2 for \$1.00
PI-A-8	1/4 " x 24"	2 for \$1.10

Beams

PI-B-2	1/16" x 10"	5 for \$1.15
PI-B-4	1/8 " x 15"	4 for \$1.30
PI-B-6	3/16" x 24"	2 for \$1.05
PI-B-8	1/4 " x 24"	2 for \$1.10

Channels

PI-C-2	1/16" x 10"	5 for \$1.15
PI-C-4	1/8 " x 15"	4 for \$1.30
PI-C-6	3/16" x 15"	3 for \$1.05
PI-C-8	1/4 " x 24"	3 for \$1.40

Columns

PI-H-2	1/16" x 10"	4 for \$1.00
PI-H-4	1/8 " x 15"	3 for \$1.20
PI-H-6	3/16" x 24"	2 for \$1.20
PI-H-8	1/4 " x 15"	3 for \$1.35

Tees

PI-T-2	1/16" x 10"	4 for \$1.00
PI-T-4	1/8 " x 15"	3 for \$1.05
PI-T-6	3/16" x 24"	2 for \$1.10
PI-T-8	1/4 " x 24"	2 for \$1.25

Styrene Sheets

Opaque white material		
PI-S-2	0.020" x 5" x 10"	\$0.25
PI-S-3	0.030" x 5" x 10"	\$0.30
PI-S-4	1.040" x 5" x 10"	\$0.35

Opaque light grey		
PI-S-6	0.060" x 4" x 12"	\$0.50
PI-S-9	0.909" x 4" x 12"	\$0.65

Transparent clear		
PI-TS-15	0.015" x 6.5" x 12"	\$0.30

FINISHING SUPPLIES

In many cases the paint job on a model can make the difference between a mediocre and a fine model. This section will be expanded in time; currently we are offering only the Floquil Poly S paints.

Poly S is a water soluble paint for polystyrene, wood, cardboard, metal, etc. No fumes, non-toxic, little odor and no fire hazard. It brushes on smoothly and dries in 20 minutes to touch, hardest surface can take several days. Thin with tap water. Clean up with tap water.

General Flat Colors

FL-PR06	Metal Primer	1 oz.	\$0.90
FL-PR09	Metal Sealer-Primer	1 oz.	0.90
FL-PF07	Plastic Prep	2 oz.	0.75
FL-PF08	Aluminum	5/8 oz.	0.50
FL-PF10	Black	5/8 oz.	0.50
FL-PF11	White	5/8 oz.	0.50
FL-PF20	Fire Red	5/8 oz.	0.50
FL-PF24	Int. Orange	5/8 oz.	0.50
FL-PF30	Blue	5/8 oz.	0.50
FL-PF40	Yellow	5/8 oz.	0.50
FL-PF51	Grass Green	5/8 oz.	0.50
FL-PF70	Gloss Finish	5/8 oz.	0.50

AVI
astroport
MINERAL POINT, WI. 53565

TOOLS

AVI Astroport recommends the Xacto line of fine tools.

Note special prices to Galactic Fraternity members to the right of the GF symbol. Non-members pay "regular" price to the left.

no.1076 CRAFT TOOL SET



A broad based arts and crafts tool set ideal for decoupage, paper craft, candle carving, picture framing, etc. Includes 2 knives with 8 extra assorted interchangeable blades, a block planer, tweezers, a razor saw blade and a jeweler's screwdriver, all in a handsome walnut finished tool chest.

\$10.00 GF9.00

CONTENTS INCLUDES ADDITIONAL BLADES!

No. 82 x-acto knife chest — Nos. 1, 2 and 5 Knives plus 14 asstd. extra blades. Handy, fitted chest. \$8.50 GF5.85

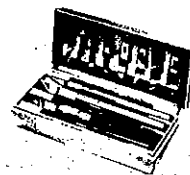

No. 83 x-acto deluxe knife chest — Nos. 1, 2 and 6 knives plus 18 asstd. extra blades. Handy, fitted chest. \$7.95 GF7.15



No. 84 x-acto knife and tool set — Contains Nos. 1, 2, 5 knives and an entire asst. of blades, gouges, routers, punches. Has X-acto planer, sander, spokeshave, balsa stripper. In wooden box, complete with see-thru cover and fitted plastic tray insert that holds and shows every tool. \$16.95 GF15.00

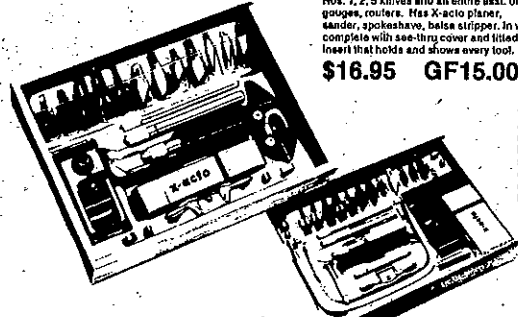

No. 85 x-acto deluxe knife and tool set — Holds Nos. 1, 2, and 8 knives and an entire asst. of blades, gouges, routers, punches, plus planer, sander, hobbycraft saw, razor saw blade, spokeshave, pin vise, screwdriver, asstd. drill bits. In wooden box, complete with see-thru cover and fitted plastic tray insert that holds and shows every tool. \$24.95 GF22.50

No. 86 x-acto knife and tool chest — Contains Nos. 1, 2, 5 knives and complete asst. of blades, gouges, routers, punches. Has X-acto planer, sander, spokeshave, balsa stripper. In handsome fitted wood chest.

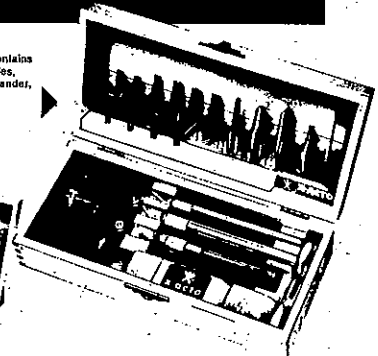

No. 87 x-acto knife and tool chest — Contains Nos. 1, 2 and 5 knives, complete asst. of blades, gouges, routers, punches; Plus X-acto planer, sander, hobbycraft saw, spokeshave, balsa stripper, pin vise, screwdriver, asstd. drill bits. In large fitted wood chest.



\$28.95 GF25.00

\$19.95 GF17.95

No. 378-C soldering iron and hot knife... for Hobby and Electronics

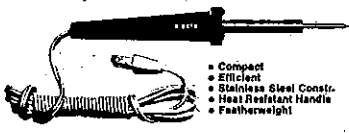

- Compact
- Efficient
- Stainless Steel Const.
- Heat Resistant Handle
- Featherweight

25 watt soldering iron — Top quality. Does the work of irons with higher wattage. Hold and use as a pencil. Replaceable tip. Narrow diameter tip gets into tight places. Develops up to 720°F. Handle remains cool. Pre-inned, nickel plated tip means longer tip life.

Hot knife — Model Building: cuts through plastics rapidly and accurately. General use: rework connectors, clear product surfaces that have epoxy or flash, remove coolant circuit board components. The No. 378 X-acto Soldering Iron and Hot Knife comes mounted on a colorful card... complete with instructions. UL approved.

\$6.00 GF5.40

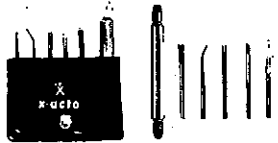

No. 348-C soldering aid kit — Contains five tools and a universal, double-chuck handle — all in an always handy, see-thru carrying case. Tools are hard chrome-plated steel, to which solder will not adhere.

\$4.50 GF4.00



No. 42-C sander — \$1.00 GF0.90

No. 42R — 5 Sander Refills: PAT. NO. 3,411,958

No. 41-C sander — \$0.85 GF0.75

5 Sander Refills: PAT. NO. 3,411,958

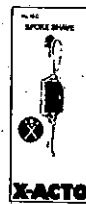

No. 66-C spoke shave — \$1.40 GF1.25

Refill Blades: No. 30 — pkg. of 2



No. 60-C block planer — \$1.90 GF1.70

Refill Blades: No. 29 — pkg. of 2

PAT. NO. 3,411,910



No. 50-C hammer set — \$5.00 GF4.50



No. 48-C balsa stripper — \$2.25 GF2.00

PAT. NO. 3,411,448

SURGICALLY SHARP- INTERCHANGEABLE BLADES for: Carving, Cutting, Etching, Hollowing, Piercing, Sawing, Scoring, Scraping, Scribing, Slicing, Slitting, Stripping, Trimming.

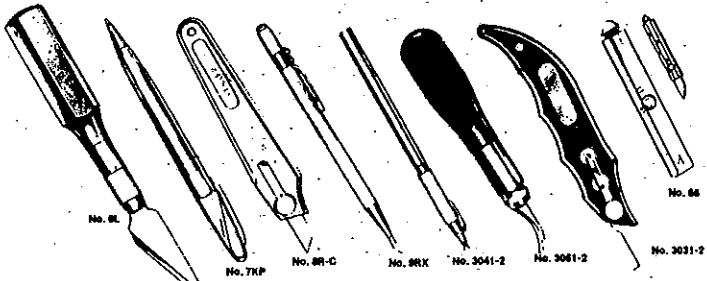
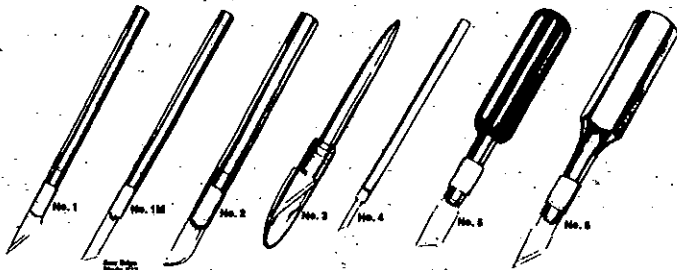

No. 1 KNIFE — For light to medium work. Aluminum handle 5" long, complete with No. 11 blade. \$0.90 GF0.80

No. 1M MICRO-KNIFE — \$1.00 GF0.90

No. 2 KNIFE — For medium to heavy work. Aluminum handle 5" long, complete with No. 22 blade. \$1.40 GF1.25

No. 3 PEN-KNIFE — Clips to pocket. "See-Thru" Cap reveals blade. Gold-plated metal barrel. Complete with No. 11 blade. Length closed — 5 1/2". Also accommodates Nos. 10 and 18 blades. \$1.75 GF1.55

No. 4 KNIFE — Aluminum handle with detachable blade 5" long with blade, 1/4" handle (5mm). \$0.85 GF0.75

No. 5 KNIFE — For heavy work. Plastic handle with metal blade lock (4 1/2" long) complete with No. 15 blade. \$1.50 GF1.45

No. 8 KNIFE — For heavy work. Solid aluminum hexagonal handle (4 1/2" long) complete with No. 24 blade. \$2.50 GF2.25

No. 8X KNIFE — For extra heavy duty. Solid aluminum hexagonal handle (4 1/2" long). Large blade. \$3.00 GF2.75

No. 7KP KNIFE-PENCIL COMBINATION — \$1.95 GF1.75

No. 8P-C UTILITY KNIFE — Reversible blade, carded with extra blade. \$0.40 GF0.35

No. 8RX — Retractable X-acto Push-Button Knife. Positive lock when open. Safety-grip handle. Ideal all-around ready-to-go knife — especially adapted for tickle work, retouching, etching, etching. For any delicate, close work where extreme accuracy is utmost. (Packed) \$3.50 GF3.15

No. 3041-2 SWIVEL KNIFE — blade turns freely, automatically, to follow intricate arcs and curves. Blade easily removed with a touch of the finger. Refill blades pkg'd. 2 per card, No. 0841-2. Ideal for Artists, Hobbyists, Craftsmen. \$2.95 GF2.65

No. 3061-2 WOODCARVING KNIFE — designed to fit the hand, for beginner as well as the professional. 5 1/2" long with No. 0104 blade. \$2.95 GF2.65

No. 3031-2 ACRYLIC CUTTING TOOL for cutting acrylics and soft metals. 2 position, retractable/replaceable blade. Refill blades, No. 0831-2 pkg'd. 3 per card \$0.99 GF0.90

No. 68 POCKET KNIFE — Stainless steel shell surgical blade, push-button operation. \$1.25 GF1.10

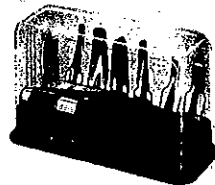

No. 77 x-acto woodcarving set — 8 gouge blades, 4 regular blades, 2 3-inch blades, No. 5 knife handle (takes all blades). On black plastic base, clear plastic top. \$5.25 GF4.75

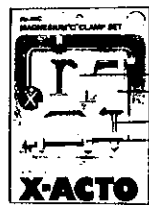

No. 46-C Magnesium C-Clamp Set — \$5.00 GF4.50

4 clamps

\$4.95 GF4.50

CONTOURED SANDERS FOR PRECISION SANDING IN METAL, PLASTIC & WOOD

No. 351 X-acto CONTOURED SANDERS. This unique and useful new kit offers five different sanding heads... 3 grip-tight handles, acrylically designed to get into those areas other sanders can't reach. Including an assortment of pre-cut sheets of plastic-backed FLEX-1-GRIT sandpaper, the Contoured Sanding Kit works equally well on metal, fiberglass, plastic or wood surfaces.

No. 351R (refill sandpaper... 5 sheets) \$0.60 GF0.55

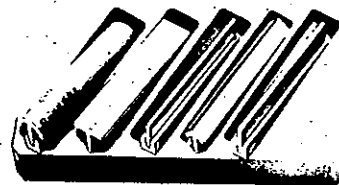

No. 75 x-acto carving chest — "The Leader" — No. 5 Knife handle, 5 asstd. regular blades in patented holder, 2 3-inch blades, 8 gouges, 4 routers. In handy, lockable chest. \$8.50 GF7.85

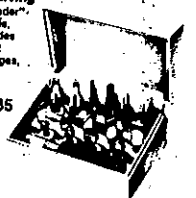

No. 460-C Mini-Clamps — 3 mini clamps of 1/4" thick high grade steel, finished in baked enamel. Screws cadmium plated to resist welding spatter. Slotted ends. Size: 1/2", 7/8" and 1-7/16" maximum coverage. \$2.75 GF2.45

\$4.95 GF4.50

CONTOURED SANDERS FOR PRECISION SANDING IN METAL, PLASTIC & WOOD

No. 351 X-acto CONTOURED SANDERS. This unique and useful new kit offers five different sanding heads... 3 grip-tight handles, acrylically designed to get into those areas other sanders can't reach. Including an assortment of pre-cut sheets of plastic-backed FLEX-1-GRIT sandpaper, the Contoured Sanding Kit works equally well on metal, fiberglass, plastic or wood surfaces.

No. 351R (refill sandpaper... 5 sheets) \$0.60 GF0.55

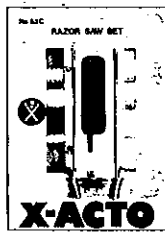

Razor Saws for fine and accurate cross-cutting, trimming and notching of metal, wood and plastic. When mounted in handle, blade with angled shank provides longer tool reach and prevents backing of knuckles (overall length of 9 1/2").

No. 53-C RAZOR SAW SET — No. 5 Handle and one each of No. 54 and No. 55 saw blades. \$3.25 GF2.95



No. 53-C razor saw and handle set — An ideal unit for every hobbyist. Platform and cover serve as storage tray. Set contains No. 5 handle and one each of No. 53, No. 54, No. 55 saw blades; No. 15 keyhole saw blade; and 5 knife blades. \$5.50 GF5.00

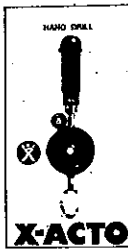

No. 47-C hand drill — \$4.50 GF4.00

X-ACTO no. 99 super-set tool cabinet

The ultimate in tool chests — containing a complete assortment of hobby tools, knives and blades fitted into a handsome wood cabinet (with drawer for storage of small parts). A compact orderly way of housing all your hobby tools. Cabinet measures 13" wide x 10" high x 5 1/2" deep. Weight: 13 1/2 pounds.

- CONTENTS:
- 1 No. 1 Knife
 - 8 Extra Refill Blades
 - 1 No. 5 Knife
 - 4 Routers
 - 1 Punch
 - 1 Razor Saw Blade
 - 1 No. 351 Contoured Sander Set
 - 1 Jeweler's Screwdriver with 1 bit
 - 1 No. 378 Cordless Power Drill — center punch, grinder, and 1 drill bit
 - 1 No. 41 Hand Drill
 - 1 No. 378 Soldering Iron/Hot Knife
 - 1 No. 44 Saw
 - 1 Tweezer
 - 1 Pair Pliers
 - 1 Bench Vise
 - 1 No. 50 Hammer Set
 - 1 No. 349 Tweezer/Heat Sink
 - 1 File Handle, with 1 needle file
 - 1 No. 40 Planer
 - 1 Large Screwdriver (with plastic handle)

\$80.00 GF69.95

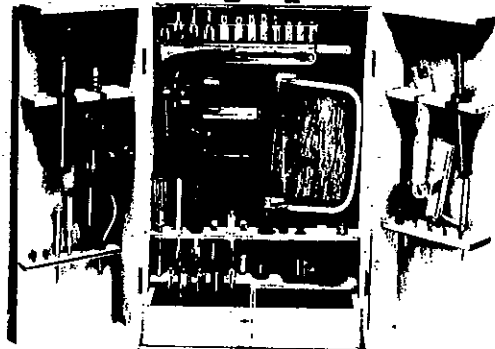

Plus FREE copy of "THE X-ACTO WORKSHOP" a Guide Book to X-acto Knives and Tools with Selected Projects.

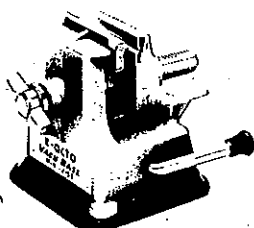

\$3.75 GF3.35

No. 370-C X-acto Mini Vacu-Vise. No screws. Just flip lever! Holds tight instantly on non-porous surfaces — Formica, glass, metal, etc. Ideal for hobbyist, do-it-yourselfer, craftsman, sportsman. Each unit individually shrink-wrapped on a colorful card.

\$55.00 GF47.50

No. 89 Deluxe Hobby Tool and Knife Chest

Extra sturdy all wood carrying case contains:

- 4 Routers
- 4 Gouges
- 8 Extra Refill Blades
- 1 Razor Saw Blade
- No. 44 Coping Saw
- No. 40 Block Planer
- Tweezer
- No. 1 Knife
- No. 5 Knife, handle only
- 1 Pair Pliers
- No. 50 Hammer Set
- No. 47 Hand Drill
- No. 351 Contoured Sander Set
- No. 360 File handle, with 3 needle files
- 1 Bench Vise
- 2 "C" Clamps
- No. 349 Heat Sink
- 1 Plastic Handle Screwdriver
- 1 Jeweler's Screwdriver, with 1 bit
- 1 Pin Vise
- 2 Drill Bits
- 1 Check Adapter

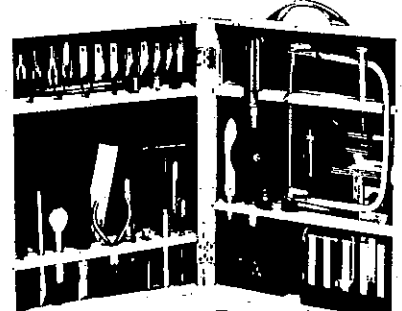

size: 14 x 10 x 5 1/2 inches weight: 8 pounds

Plus FREE copy of "THE X-ACTO WORKSHOP" a Guide Book to X-acto Knives and Tools with Selected Projects.

COMPETITION MODEL ROCKETS COMPANY PRODUCTS

FROM **AVI**
astroport
MINERAL POINT, WI. 53565

Col. Howard Kuhn of Competition Model Rockets has fashioned a line of rockets that are aimed at the serious competitor, though they are fine for sport flying.

CMR kits feature special highly efficient lightweight plastic nose cones that require no filing for a smooth finish. They are manufactured to actual plotted geometric ogive and parabolic curves. The plastic is extremely durable and smooth. No finish is required, although they can be painted using standard paints for plastics.

Tests indicate that the major source of drag on a model rocket is caused by the launch lug, which can account for about 20% of the total drag on the model. CMR has designed a special 'pop' launch lug which fits a standard launch rod, is simple in construction and foolproof in operation. It is a standard item in most CMR kits.

Each CMR model is thoroughly tested in competition before being introduced into the line. The Manta and Elo have had a history of being consistent winners on both the regional and national levels.

AVI Astroport is proud to be able to bring this new addition of products to our catalog.

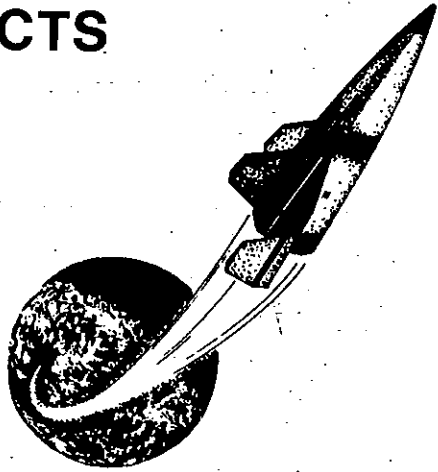

MANTA

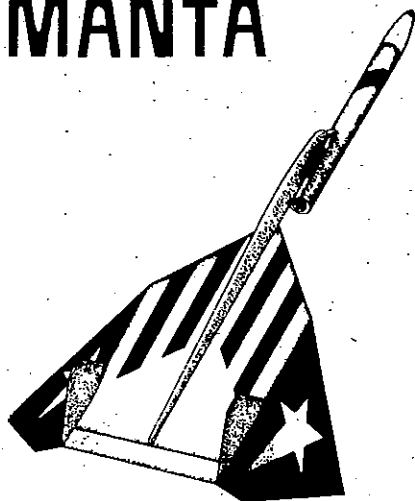

The championship boost glider. This unique rocket boost glider is easy to build and adjust. Very stable during both power and glide phase. Can be flown in all classes of NAR Boost glider events. Features pre-cut parts, 'pop' power pod, lightweight, high strength.

This glider has compiled a long list of victories in both National and Regional meets.

Specifications:

Length: 12"
Wing Span: 8.5"
Glider Weight: 12 gms
Recommended Engines: 18mm x 70mm
1/2A6-2, A5-2, B4-2, C6-3
Catalog No. CMR-OBG1
Price: \$2.75

Paratrooper

This mini-jet rocket was designed for the parachute duration event. The larger body will hold a good sized parachute while the plastic boat tail decreases drag and increases performance. Kit features plastic nose cone, plastic boat tail, 1/4 mil. aluminumized mylar duration parachute, and sheet plastic fins.

Specifications:
Length: 12.5"
Diameter: 0.736
Recommended Engines:
1/2A3-3m, A3-4m, B3-5m
Catalog No. CMR-00C8
Price: \$2.75

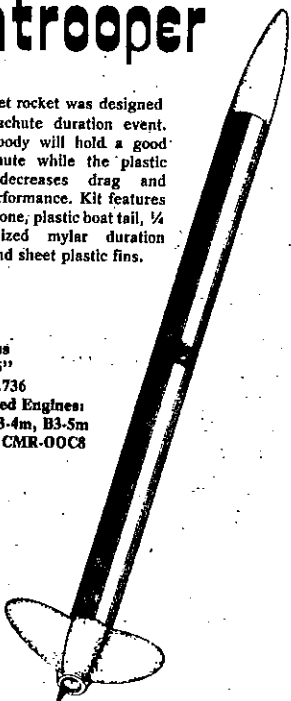

ZVPL

Zero Volume Piston Launcher is the name of the game. This unit, in kit form, allows you to make use of both the gas pressure of confined exhaust gases and as well as Newton's third law in lifting your contest rockets.

The basic unit is designed for use with the 13mm mini-jet engines.

Catalog Number: CMR-OBL1
Price: \$2.50
Adapter for 18mm engines: Cat. No. CMR-OBL1a \$0.50

Orbitron

A new parasite Micro-Manta boost glider. The glider attaches to the side of a special carrier rocket which detaches upon ejection and returns by streamer. A real performer.

This contest glider has been officially timed at 306 seconds using a 1/2A3-3m engine.



Specifications:
Glider:
Wing Span: 5.5"
Length: 7.75"
Weight: 4 grams
Carrier Rocket:
Length: 13.5"
Diameter: 0.558

Recommended Engines:
1/2A3-3m, A3-4m, B3-5m
Catalog Number: CMR-OBG3
Price: \$2.50

BREAK AWAY

An unusually designed parachute duration rocket that comes apart to eject large sized parachutes from a small diameter body tube. Precut 1/64" plywood fins, large 28" diameter lightweight chute, plastic nose cone, all parts necessary for construction.

Specifications:
Length: 15"
Diameter: 0.766"
Net Weight: 20 gms
Catalog Number: CMR-00C1
Price: \$2.75
Recommended Engines:
1/2A6-2, A5-2, B4-4

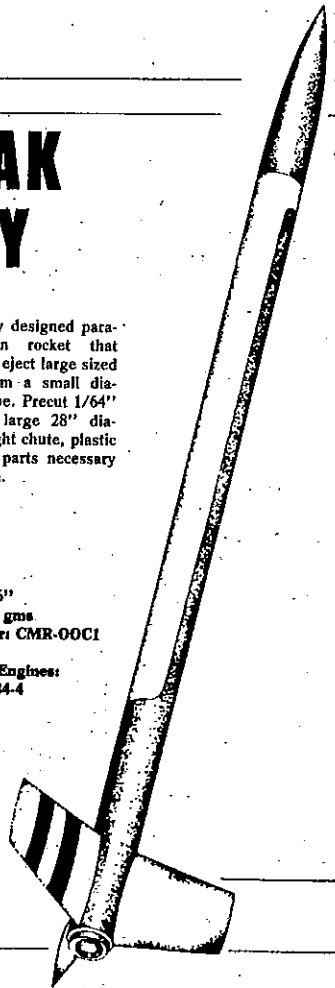

Fins

Pre-formed airfoil plastic fin kits for making lightweight, streamlined 3 piece plastic fins. Kit comes complete with instructions and enough material for making 3 four fin rockets or 4 three fin rockets.

CMR-00F1 Fin size 1 3/8" x 1 1/2" \$0.70
CMR-00F2 Fin size 1 3/4" x 2" 0.80
CMR-00F3 Fin size 2" x 2 1/2" 0.90

Create-A-Cal

A do-it-yourself decal kit. Make your own decals for special effects, scale, super scale, NAR numbers, etc. Complete with 6 sheets (3" x 6") Create-A-Cal paper and topping solution.

Complete kit and instructions
Cat. No. CMR-CAC1 \$2.50

ROBIN

A new egg lifter for 18mm engines only. Single stage for the NAR robin and pigeon egg lofting event. Designed for easy conversion to a two-stage rocket using CMR parts. Design your own lower stage and increase the versatility of this model. 'Pop' launch lug, pre-cut plywood fins, the famous CMR egg capsule, are among the many features of this kit.

Specifications:
Length: 14"
Diameter: 0.766
Recommended Engines:
C6-5, D6.1-6.75
Catalog No. CMR-00C9
Price: \$3.95

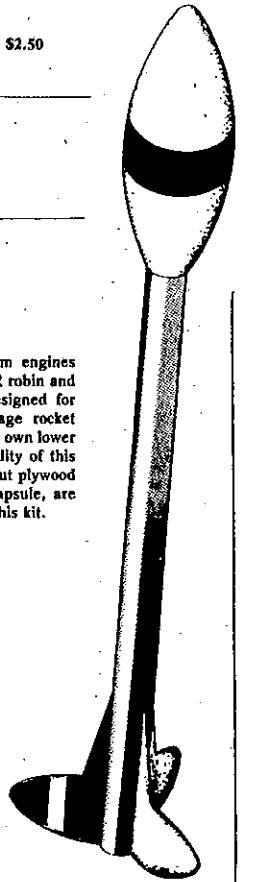

Tube Cutter

Adjustable, simple to use body tube cutter designed to cut all sizes of model rocket body tubes to any length. Make a perfect cut every time. An invaluable aid to the custom rocket builder.

Catalog No. CMR-OBT1 \$2.25

Buzzard

Especially designed for the NAR rocket glider event. An unusual new sliding wing concept converts to a boost glider. Comes complete with pre-cut parts, molded plastic wing slides, plastic nose cone and instructions.

Designed for AVI Astroport mini-jets. Recommended for the experienced modeler. Placed second at NARAM 13 in 'D' division (now C).

Specifications:
Wing Span: 13"
Length: 13"
Glider Wt. 15 gms.
Recommended Engines:
1/2A3-3m, A3-4m, B3-5m
Catalog No. CMR-OBG4
Price: \$2.75

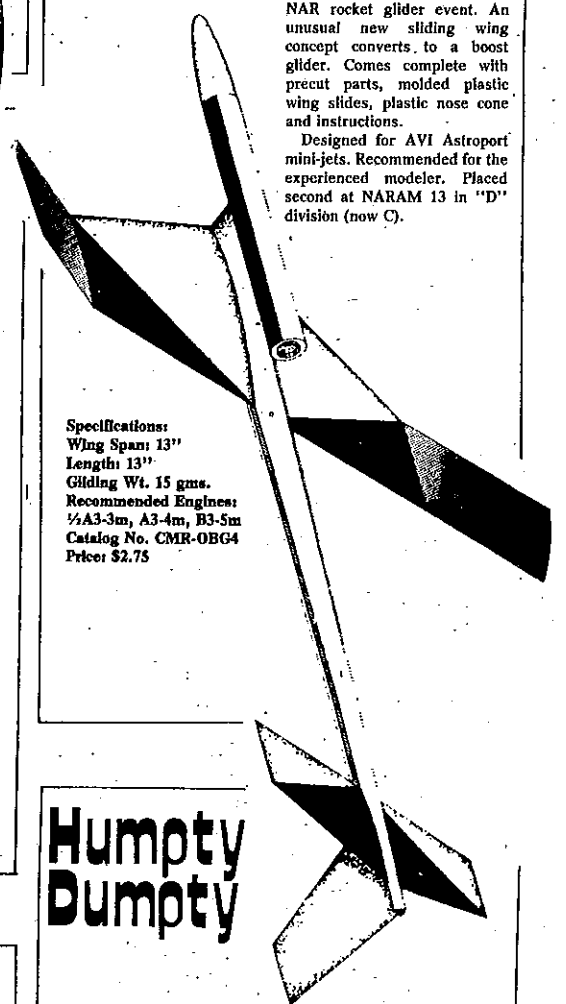

Humpty Dumpty

AN EGG LOFTERS MYSTERY
KIT! NO ILLUSTRATION AVAIL-
ABLE, NO SPECS.

CMR-00C13 \$3.25

ELO

The bird that changed egg lofting history and still going strong. Improved two-stage rocket designed especially for all NAR egg loft competition events. Special egg capsule is foam rubber lined for use of delicate payloads. Can be flown single stage.

A constant winner complete with pre-cut 1/32" plywood fins, special stand-off 'pop' launch lug for 3/16" rod, and materials required for 18mm or 21mm engine use.

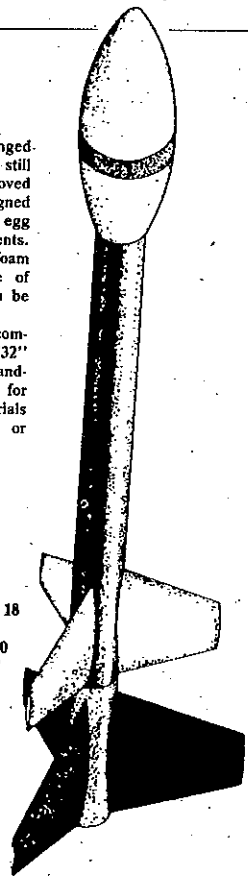

Specifications:
Length: 17"
Diameter: 0.920"
Net Wt. 43 gms

Recommended Engines: 18 mm diameter
Lower Stage: B14-0, C6-0
Upper Stage: B6-6, C6-7
Catalog Number:
CMR-00C3
Price: \$4.50

Body Tubes

Lightweight, strong, three-ply, spiral wound paper tubes. Outer layer is a special white paper covering which can be sanded with fine sandpaper for that extra smooth finish. RB50 fits into RB52; RB74 fits into RB77; and RB90 fits into RB92, permitting special staging, making payloads, etc.

Cat. No.	Length	ID	OD	Thick	Price
CMR-RB50	12"	0.538"	0.558"	0.010"	\$0.25
CMR-RB52	12"	0.564"	0.584"	0.010"	\$0.25
CMR-RB74	12"	0.710"	0.736"	0.013"	\$0.30
CMR-RB77	12"	0.740"	0.766"	0.013"	\$0.30
CMR-RB90	16"	0.864"	0.890"	0.013"	\$0.40
CMR-RB92	16"	0.894"	0.920"	0.013"	\$0.40
CMR-RB120	18"	1.120"	1.170"	0.025"	\$0.55

D Region Tomahawk

This is an exact scale model of the single stage sounding rocket, NASA Flight No. 12.08GT, built by the Astro-Met Division of the Thiokol Chemical Corporation. This rocket was designed and flown to determine vehicle performance and establish payload environment during flight before acceptance in the NASA rocket stable. The performance was as predicted and the basic rocket was accepted by NASA. Model is precisely scaled from full size manufacturer's drawings. Color was determined from many NASA color photographs. Ideal for NAR scale and scale altitude events. Original model won first place in scale and first in scale altitude at NARAM 11. Kit contains detailed instructions, precision scale plastic nose cone, pre-cut fins, true to prototype shroud, 'pop' launch lug, screw head embossing tool. Recommended for experienced modelers.

Specifications:
Length: 20"
Diameter: 0.930"
Net Weight: 39 grams
Recommended Engines: (B3-4, C4-4, D4-4)
B3-3, C6-4, D6.1-6.75
Catalog No.: CMR-00S1
Price: \$4.95

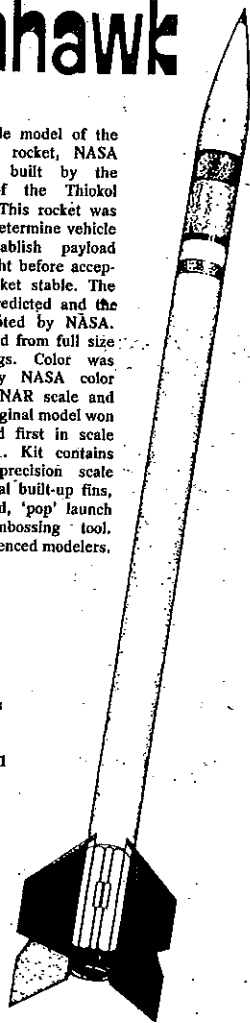

egg capsules

Special lightweight plastic nose cone with foam rubber lining molded to shape of egg, complete with shock cord attachment. Used for lofting eggs or delicate payloads. DENC series for double egg.

CMR-ENC77	Fits RB77 body tube	\$2.85
CMR-ENC92	Fits RB92 body tube	2.85
CMR-ENC120	Fits RB120 body tube	2.85
CMR-DENC92	Fits RB92 body tube	3.25
CMR-DENC120	Fits RB120 body tube	3.25

Pop Lugs

'Pop' launch lug kits containing all parts and instructions necessary for adding a 'pop' launch lug to any rocket:

CMR-00L5	5" long for 1/8" diameter rod	\$0.30
CMR-00L8a	5" long for 1/8" standoff for 1/8" rod	0.40
	8" long for 1/8" diameter rod	0.35
CMR-00L8a	8" long 1/2" standoff for 1/8" rod	0.45
CMR-00L8b	8" long 1/2" standoff for 3/16" rod	0.50

New 'pop' launch lug kits designed to be built in the field without the use of glue. Fits all rockets.

CMR-00L5a	5" long for 1/8" diameter rod	0.30
CMR-00L8a	8" long for 1/8" diameter rod	0.35

EFFY

High efficiency single stage starter kit with all the features of the regular kits except the 'pop' launch lug. Kit contains plastic nose cone, pre-cut fins, parachute and instructions.

The "EFFY" has accumulated an impressive list of victories in altitude and design efficiency events.

Specifications:
Length: 15"
Diameter: 0.736
Net Weight: 18 grams
Recommended Engines: 1/2A6-4, A4-5, B6-6, C6-6
Catalog Number: CMR-00C4
Price: \$1.85

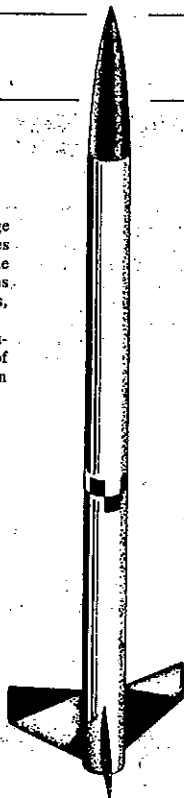

VIP

A Very Impressive Performer. Mini-jet powered bird designed for streamer duration. The kit features pre-cut elliptical plywood fins, parabolic plastic nose cone and 10 foot aluminumized mylar streamer. An excellent performing altitude rocket.

Specifications:
Length: 9.5"
Diameter: 0.584
Recommended Engines: 1/2A3-5m, A3-6m, B3-7m
Catalog Number: CMR-0C11
Price: \$1.95



PEN

A high altitude mini-jet powered rocket that is easy to build but with contest performance. It's long length is designed for better tracking and extra stability for the NAR altitude events. Precut plywood fins and a plastic parabolic nose cone adds to the performance.

Specifications:
Length: 13.5"
Diameter: 0.558
Net Weight: 5 grams
Recommended Engines: 1/2A3-5m, A3-6m, B3-7m
Catalog Number: CMR-0C10
Price: \$1.25

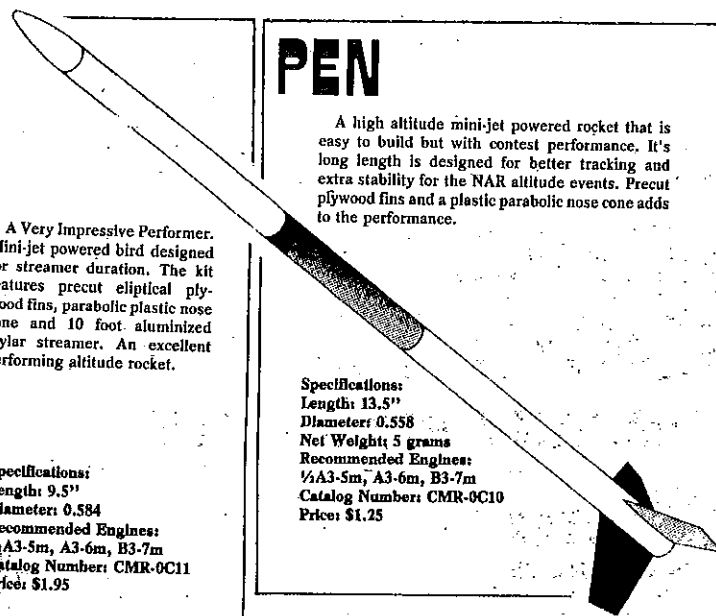

Rapier

A great sport flyer that was designed as an easy to build parachute duration bird. Utilizes 18mm diameter engines. So versatile that it can be used with the egg capsule and Marcus strap-on boosters to lift payloads to high altitudes. Comes with adapter to fit 21mm engines also, plastic nose cone, 'pop' launch lug, 12" diameter parachute for sport flying. Will take up to a 36" diameter parachute.

Specifications:
Length: 15"
Diameter: 0.890
Net Weight: 28 grams
Recommended Engines: 1/2A6-4, A5-4, A8-5, B6-6, C6-7
Catalog Number: CMR-00C5
Price: \$2.50

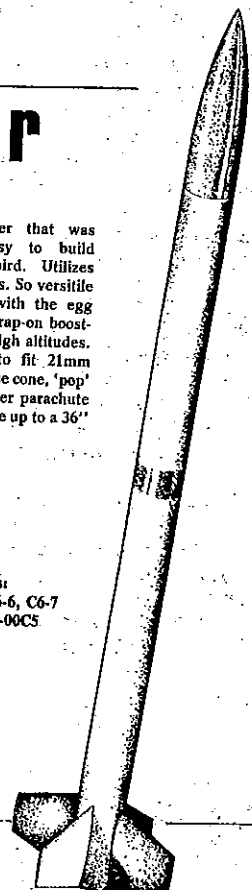

HYPHER

This is a two-stage high performance rocket designed for payload and altitude events. The upper stage can be flown separately as a Quadrathlon bird. Almost any combination of booster and upper stage engines can be used depending upon total impulse restrictions of the event flown. Precut plywood fins, 'pop' launch lug, plastic nose cone and parachute. Payload section designed for a standard NAR payload.

Recommended Engines:
Lower Stage: 1/2A6-0, A8-0, B6-0, C6-0
Upper Stage: 1/2A6-4, A8-5, B4-6, C6-7
Specifications:
Length: 18"
Diameter: 0.766
Net Weight: 25 grams
Catalog Number: CMR-00C2
Price: \$3.25

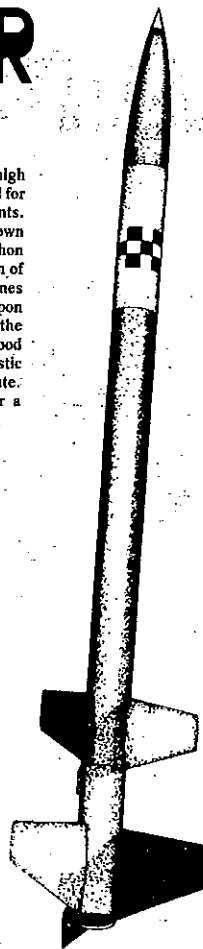

Nose Cones

White lightweight plastic nose cones manufactured to actual plotted geometric ogive and parabolic curves. Kits consist of one piece nose cone, adapter for body tube, shock cord attachment, and instructions.

Cat. No.	Fits Tubing Size	Length	Price Ea.
CMR-NC50P	CMR-RB50	1.5"	0.40
CMR-NC52P	CMR-RB52	1.5"	0.40
CMR-NC74S	CMR-RB74	1.5"	0.45
CMR-NC740	CMR-RB74	2.25"	0.50
CMR-NC74P	CMR-RB74	2.25"	0.50
CMR-NC77S	CMR-RB77	1.75"	0.55
CMR-NC770	CMR-RB77	2.6"	0.60
CMR-NC77P	CMR-RB77	2.6"	0.60
CMR-NC90S	CMR-RB90	1.90"	0.65
CMR-NC900	CMR-RB90	2.75"	0.70
CMR-NC90P	CMR-RB90	2.75"	0.70
CMR-NC92S	CMR-RB92	2.00"	0.75
CMR-NC920	CMR-RB92	2.85"	0.80
CMR-NC92P	CMR-RB92	2.85"	0.80
CMR-NC120P	CMR-RB120	3.25"	0.90
CMR-PNC52	CMR-RB52 (Payload carrier)	1.25	

MARCUS

This unique kit is a strap-on booster designed to supplement the main engine to provide additional weight lifting capability for lofting heavy payloads. Makes any rocket a cluster payload. After lift-off, boosters drop off and are recovered by streamer. Two or four boosters can be used for four fin rockets while three boosters are needed for 3 fin rockets. Recommended for the experienced rocketeer.

Specifications:
Length: 7.5 inches
Diameter: 0.736"
Recommended Engines: A8-0, B6-0, B14-0, C6-0
Catalog No.: CMR-00C6
Price: Each \$1.20



Sting Ray

A high performance boost glider designed especially for AVI Astroport mini-jets. Kit comes complete with pre-cut parts, a special pop pod and movable flaps. Patterned after the Manta, this version incorporates all the latest developments.

Specifications:
Wing Span: 7.5"
Length w/o Pod: 11.5"
Recommended Engines: 1/2A3-3m, A3-4m, B3-5m
Catalog No.: CMR-0BG2
Price: \$2.95

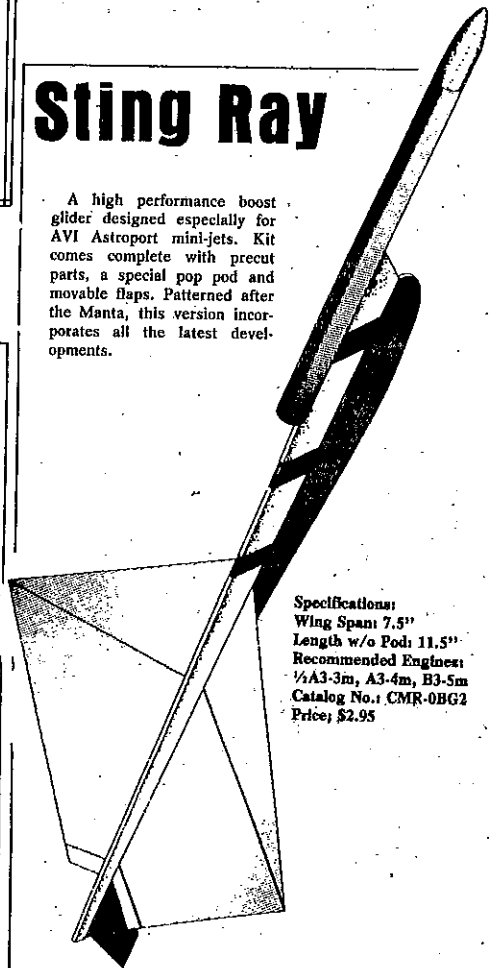

Payload Weights

One ounce lead weight to meet NAR-FAI specifications. Fits CMR-RB77 body tube and CMR-PNC52 payload capsule. CMR-0PW1 \$0.60.

Parachute Kits

Lightweight circular parachutes. Kit contains pre-cut circular canopy, special shroud lines, tape strips, snap swivels and instructions.

CMR-P8M	8" Diameter 0.00025" thick,	\$0.30
CMR-P12M	12" Aluminumized Mylar	0.40
CMR-P12MH	12"	0.45
CMR-P18M	18"	0.45
CMR-P18MH	18"	0.70
CMR-DP18MH	18"	0.75
CMR-P24M	24"	1.05
CMR-P24MH	24"	1.15
CMR-DP24MH	24"	1.15
CMR-P28M	28"	1.30
CMR-P30M	30"	1.60
CMR-P36M	36"	1.60
CMR-P36MH	36"	1.70

DP denotes Double Thickness or 0.0005"

Start

The ideal beginner's contest kit. Parabolic plastic nose cone, pre-cut balsa fins, clear instructions, ease of construction, low cost, make this kit a good one to start with.

Streamer recovery and a new type of shock cord attachment simplify building. A good model for Streamer Duration and altitude events. Added to its simplicity is the same high performance contest standards inherent in all CMR kits.

Specifications:
Length: 10.5"
Diameter: 0.736
Net Weight: 12 grams
Recommended Engines: 1/2A6-4, A6-4, B6-6
Catalog Number: CMR-00C7
Price: \$1.20

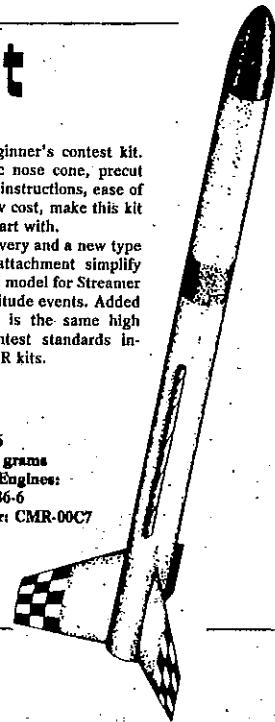

Other

Fin Jig Kits: Materials and instructions required to make simple fin jig to allow fins to be aligned and held in place during gluing to body tube. Fits all thicknesses of fins. Simple to make and easy to use. Fits all sizes of body tubes up to 2 1/2" in diameter.

CMR-0FJ3	Used for 3 fin rockets	\$0.30
CMR-0FJ4	Used for 4 fin rockets	0.30

NOTE: There is a limit in this issue of our catalog as to the number of CMR products we can list. Others are available that will be included in a later issue. If there are other CMR items you wish to order feel free to do so, making special note of it.

NON-FLYING DISPLAY SPACE MODELS

With your help and support we will expand this section of our catalog greatly in future editions. For now this is a reasonably comprehensive list of domestic offerings.

If you know of other items available from manufacturers that are not represented here please send us a letter describing those items along with the name of the company that produces them.

All Items
On This Page

\$2.99 each

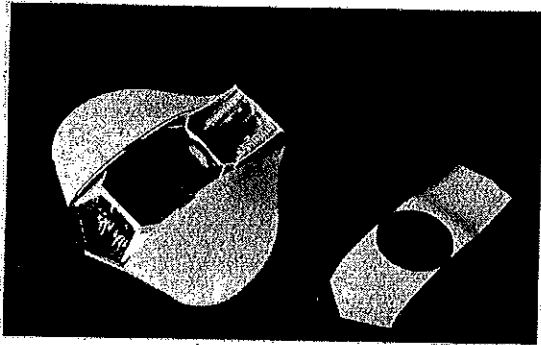

AUR-0254 THE FLYING SUB
from "Voyage to the Bottom of the Sea"

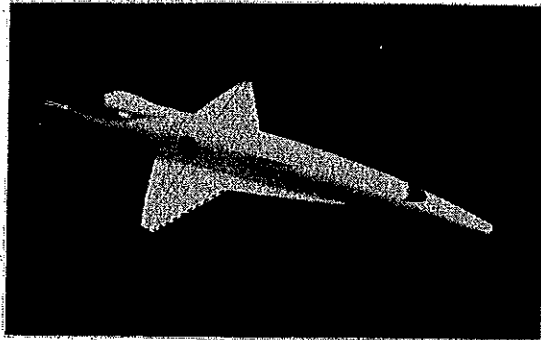

AUR-0252 SPACE SHUTTLE ORION
from "2001: A Space Odyssey"

AURORA®

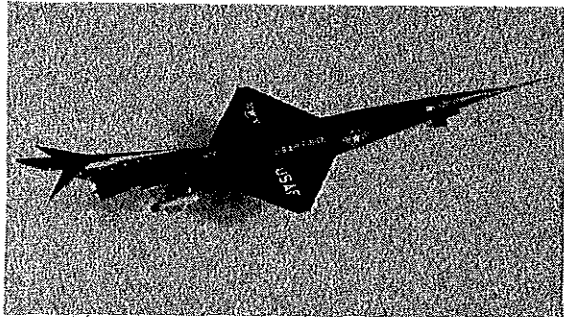

AUR-0251 NB-544 RAGNAROK NUCLEAR BOMBER
of the "Star Legion"

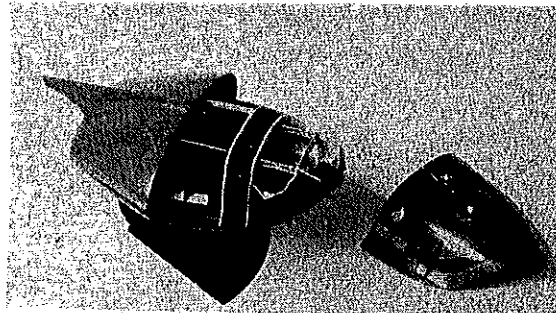

AUR-0255 ROCKET TRANSPORT SPINDRIFT
from "Land of the Giants"

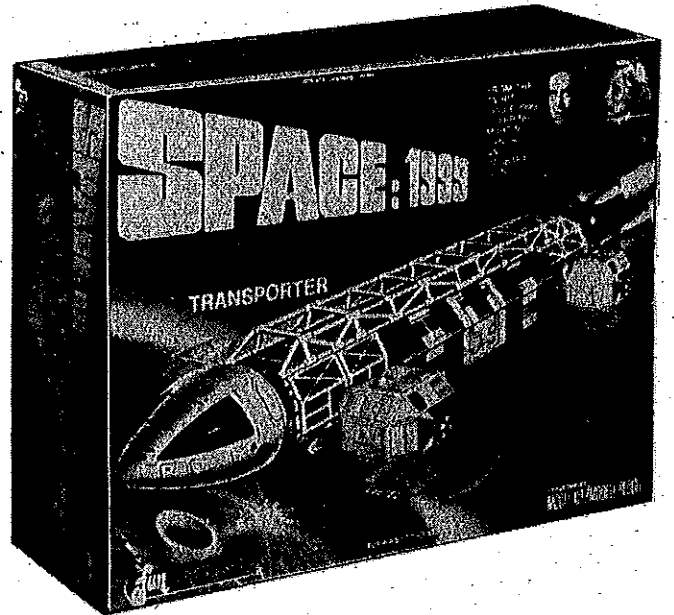

SPACE: 1999

MPC-1901

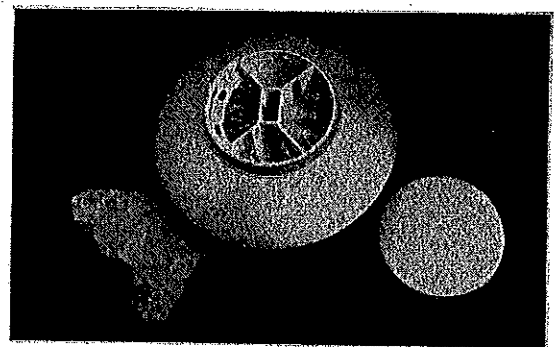

AUR-0256 FLYING SAUCER of "The Invaders"

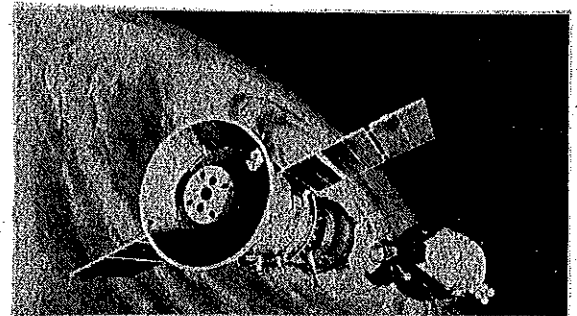

U.S.-SOVIET SPACE LINK-UP
1/96 Scale

REV-1800

*Contains two spacecraft — the U.S. Apollo and the Soviet Soyuz * Docking Module * Separate command modules and service modules for Apollo * Soyuz orbital and instrumental assembly modules separate from descent vehicle * One Astronaut and One Cosmonaut symbolic of five-man crew * U.S. and Soviet decals * Stand holds linked spacecraft and docking module in realistic docking position * Explanation of test project and its purpose included in kit.

am t STAR TREK



S957 ROMULAN SPACE VESSEL

Battleship of the ruthless Romulans. Big-scale model like Enterprise and Klingon. Giant color decal!

NEW
NEW

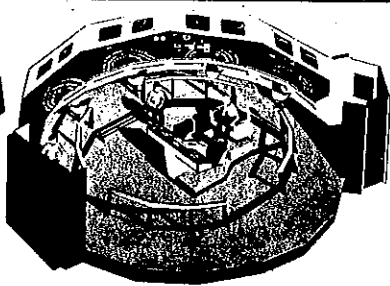

S950 U.S.S. ENTERPRISE 'BRIDGE'

A must for Star Trek fans! Big (12" diameter) detailed model of the Starship Enterprise's nerve center. Includes command module, main viewing screen, elevator, figures of Captain Kirk, Mr. Spock and Helmsman Sulu.



S958 STAR TREK EXPLORATION SET
Detailed scale models of instruments used by Enterprise crew. Phaser, Tricorder and Communicator are easy to assemble, big enough to act out Star Trek adventures!

S959 "GALILEO 7" SHUTTLECRAFT
Big-scale model of shuttlecraft carried aboard Enterprise for scouting and landing missions. Upper fuselage removes to show interior detail!

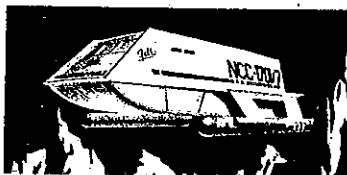

S952 KLINGON BATTLE CRUISER
Alien battle cruiser of the Klingon Empire—the "bad guys" of deep space! Same big scale and detail as "Enterprise" model!



S951 U.S.S. ENTERPRISE
Flagship of Starfleet Command! Large scale model includes special decal with names and numbers of all Starships!

U.F.O.

S960 U.F.O. MYSTERY SHIP
Interplanetary vehicle from "somewhere out there" emits luminous glow in the dark! Large scale model (13" long) carries mini scout ship. Opening launch deck doors. Display stand included.

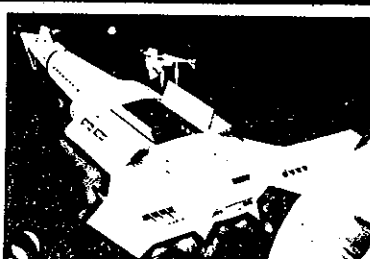

Revell

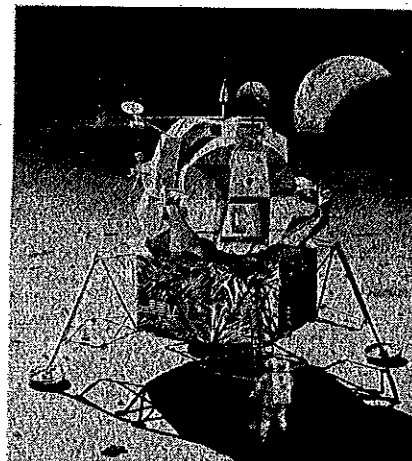

TRANQUILLITY BASE
1/48 Scale

REV-1861

Easy to assemble plastic kit of man's first base on the moon. This exacting scale model of the Apollo II Lunar Module separates into ascent and descent stages and includes two astronaut figures (one stepping on the moon!) An American flag, clear windows, detailed thrusters and antenna and official NASA markings are also featured.

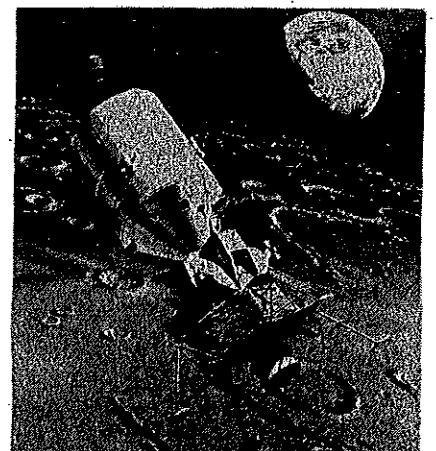

APOLO 11 COLUMBIA & EAGLE REV-1862
1/96 Scale

Easy to assemble plastic kit of the spacecraft that first took man to the moon! Here is the highly detailed model of Apollo II command ship "Columbia" and lunar module "Eagle". Three Astronaut figures (one stepping onto the moon!) are included. Comes complete with simulated lunar surface base with special support arm for the orbiting Columbia. Clear Windows and Official NASA Markings are also featured.

'MODEL AEROSTATS'

NEW KITS

HOT AIR BALLOONS

Do you want to build a really big flying model? How about something with a volume of over 500 cubic feet. OK, then work your way up to the SILENT 12, a real flying hot air balloon that works on the same principles as the sport balloons you hear so much about today.

Model rocketeers can use tethered hot air balloons as locators for their rocket meets. Their slow rise into the sky and gentle return for another 'launch' are a real attention getter.

These models carry no fire or flame aloft. They are constructed out of light durable model airplane paper and come in kit form. The kit includes instructions, the pre-cut gores ('panels'), wire hoop for inflation hole.

You must construct an elbow of 8" furnace pipe with a window screen top (not included in kit). Instructions for set up and launcher are included. The fuel is not included. Fuel is Processed Solid Solar Energy . . . or more precisely, "crumpled newspapers."

Add a new dimension to your Aerospace Modeling activities, buy one today.

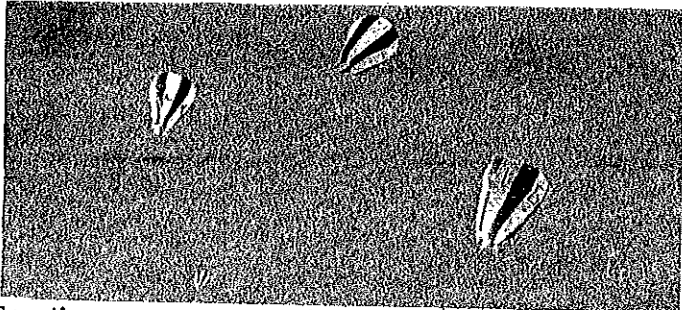

Four tissue paper aerostats climb into the sky during the long-distance contest for kit balloons. This year's race saw twice as many participants as the First Annual Albuquerque Tissue Paper Balloon Race.

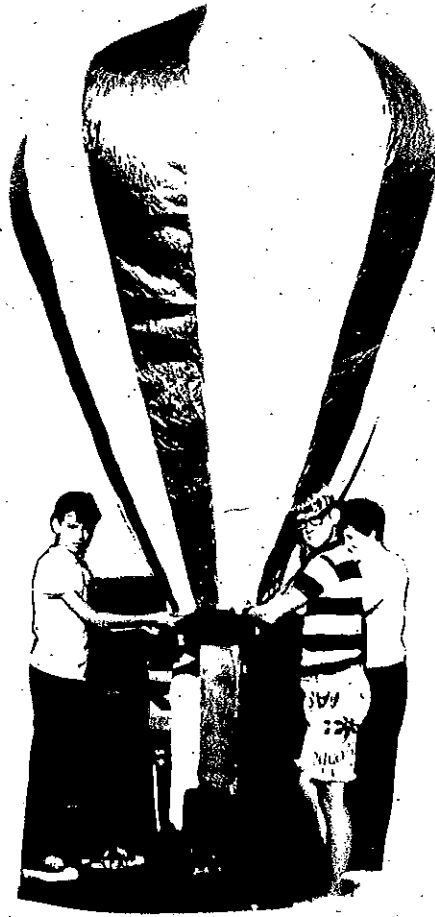

Preparing for Ascent

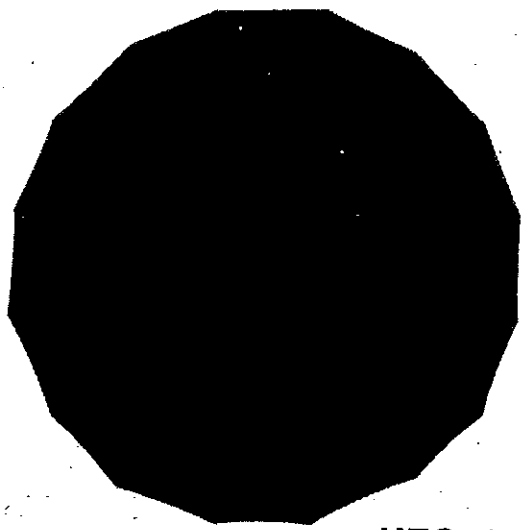

UFO Aloft

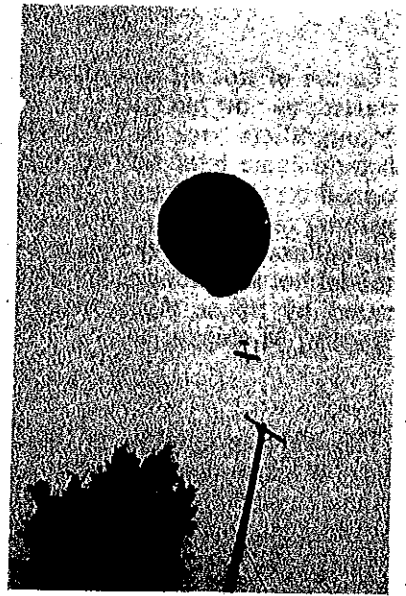

MODEL PLANE GOES UP.

NOTICE: Although these balloons do not carry fire aloft it is possible for one to catch fire while loading with hot air. Simply release and it will consume itself in the air. Do not fly near trees, power lines or tall buildings. **DO NOT FLY IN AREAS WHERE THERE ARE RESTRICTIONS** or where common sense would indicate there is a fire hazard. Never carry a fire or heat producing device aloft in one of these models.

GULLIVER 6

PQ 2

Typical inverted droplet shape. Six foot across at widest diameter. Constructed of 'Jap' tissue with gores pre-cut. Alternate gores of different colored tissue. A good model to begin with.

Catalog Number HAB-0101
Kit Price \$2.50

UFO NINE

PQ 2

You've built the two standard designs and now you can try something outside of the usual. The UFO NINE has a flatter profile and looks like a saucer on its way up and down. Add your own designs and artwork to the exterior for un-earthly vehicles. Greatest dimension is nine feet.

Catalog Number HAB-0103
Kit Price \$4.50

CALORIS 9

PQ 2

The Caloris 9 has roughly (1.5) three or roughly three and one third times the lifting power of the above model. Same general construction using the strong tissue for the gores. Your second Model Aerostat to build. Nine feet in diameter.

Catalog Number HAB-0102
Kit Price \$3.50

SILENT 12

PQ 2

The Silent 12 is 12 feet in diameter with classic proportions and a weight lifting capability of 8 times that of the 6 foot balloons. It rises silently and can carry a camera payload, even an ESTES Cineroc or would we call it a 'cineball'. Multi-colored cores. Same simple construction.

Catalog Number HAB-0104
Kit Price \$5.50

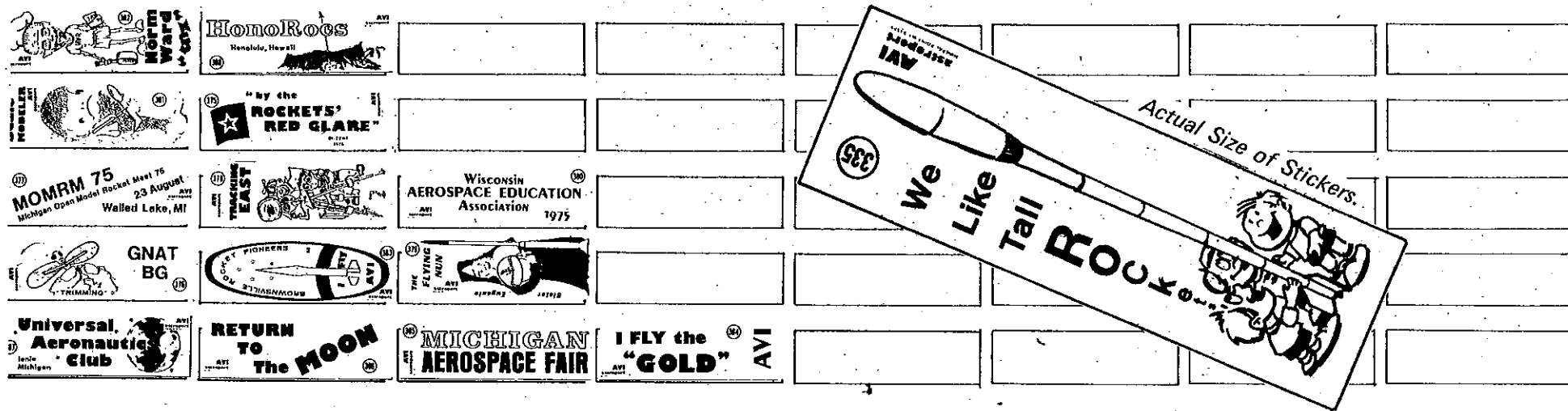

SPACE STICKERS

Illustrations of AVI Astroport Space Stickers first appeared in our April 1975 Catalog. They were in instant demand. We have expanded the line to over 70 items at this point and we will continue to add new stickers to commemorate Space Events, NAR and AMA sanctioned contests, Space and Model Rocket Clubs. We'll also continue to issue FUN and CARTOON stickers.

Although we give some stickers free with each order, many rocketeers have started to collect the series so we've illustrated them so you can order just the ones you want. Stickers of your choice are \$0.10 each. Please order by number and name.

If you want a selection of stickers, our choice, then send \$0.50 for 16 different.

NAR Sections send in your logo and a sketch of desired stickers and AVI Astroport will work one up for you.



SOME FREE
with EVERY ORDER

Galactic Fraternity

Any person that places an order for \$10 or more in a given calendar year will receive a Galactic Fraternity (GF) membership and card if he requests it. Fill out the form to the left of the order form in this catalog.

MEMBERSHIP BENEFITS...

1. You will be assigned a permanent GF identification number.
 2. You will receive an official GF membership card.
 3. Your name will be kept on a special GF list, and you will periodically receive notification of "special offers" or bonuses available only to GF members.
 4. If you use your GF identification number each time you order, you will find a free token, surprise gift when you receive your order from AVI.
 5. You will be notified as more items, articles, and benefits become available to GF members.
- Join, and help the GF grow. The more members involved the more benefits we can provide.
6. Note special GF discount prices on certain items in catalog.

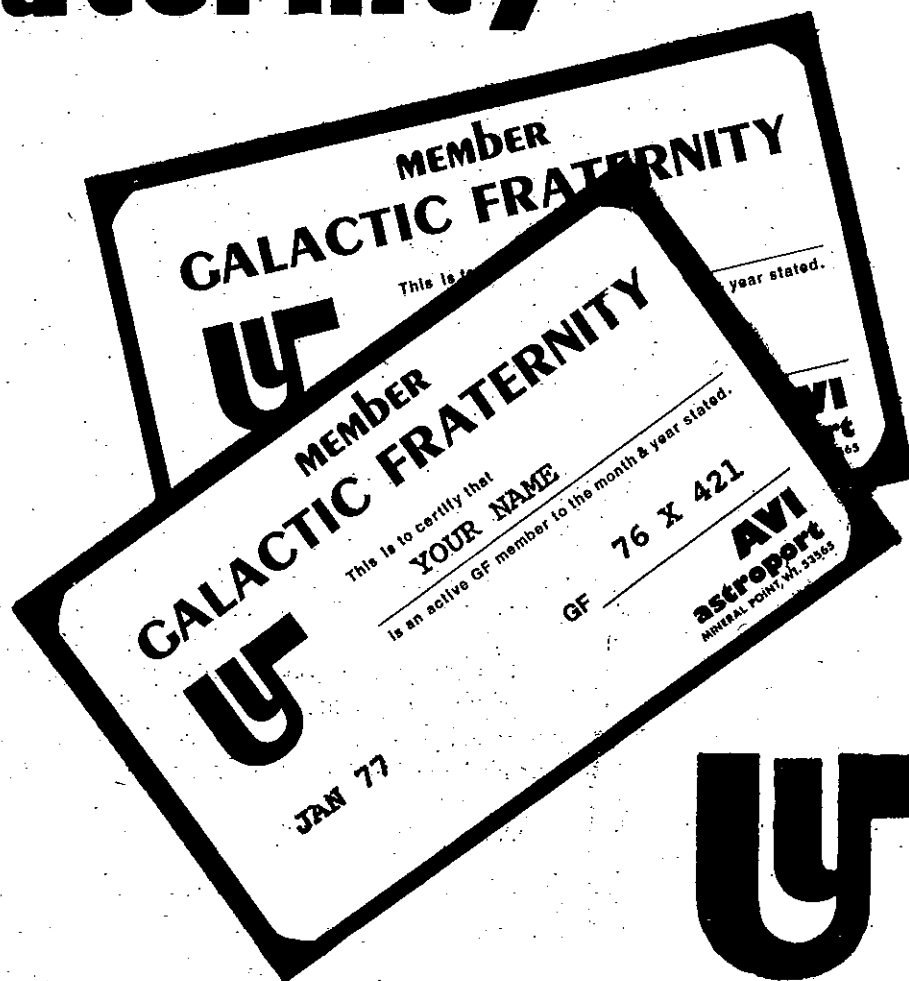

ESTES PRODUCTS FROM AVI astroport

MINERAL POINT, WI. 53565

AVI Astroport is happy to offer the Estes Industries line of model rocketry products to our mail order customers.

We began selling the Estes line in 1963 through our retail hobby store. It is remarkable how the hobby has changed in the last dozen years.

AVI Astroport thanks the personnel at Estes for their cooperation in supplying information and art work.

Note the special prices to GF members.

THREE PAGES OF ESTES ROCKETS, ENGINES & EQUIPMENT

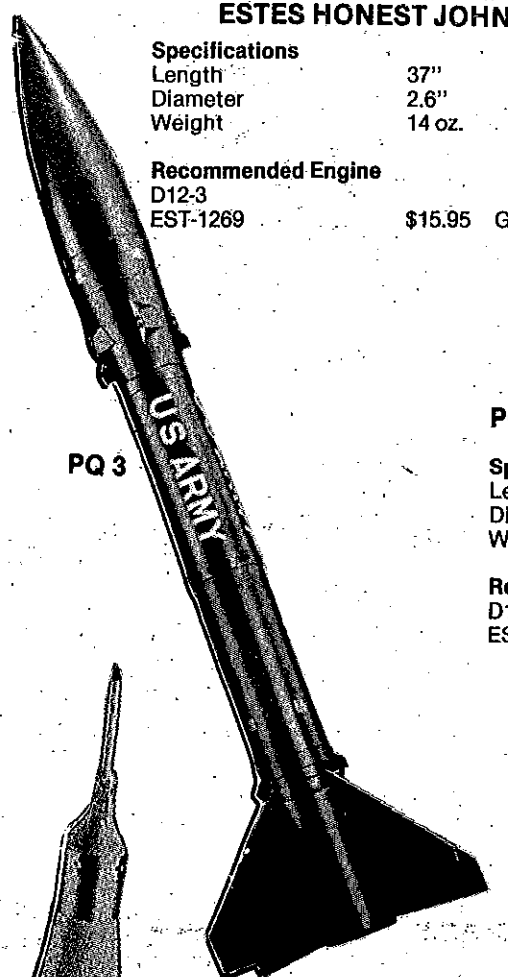

ESTES HONEST JOHN

Specifications
 Length 37"
 Diameter 2.6"
 Weight 14 oz.

Recommended Engine
 D12-3 EST-1269 \$15.95 GF14.95

PQ 3

PQ 3

Specifications
 Length 33.5"
 Diameter 3.938"
 Weight 12.5 oz.

Recommended Engine
 D12-3 EST-1267 \$15.95 GF14.95

ESTES GERMAN V-2

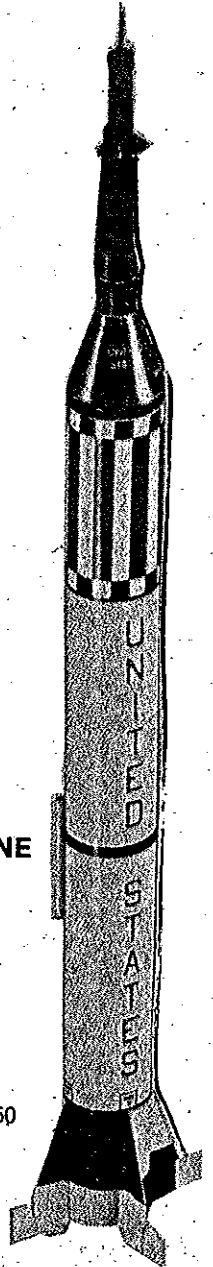
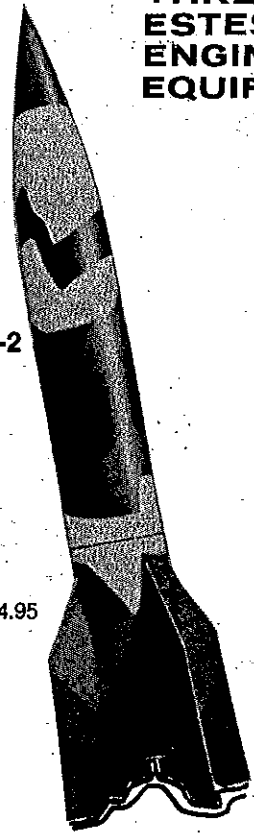

ESTES MERCURY REDSTONE

PQ 5

Specifications
 Length 23.5"
 Diameter 1.637"
 Weight 2.1 oz.

Recommended Engines
 A8-3 B6-4 (First flight) B6-5
 EST-1241 \$4.95 GF4.50

ESTES SATURN 1-B

Specifications
 Length 37"
 Diameter 3.938"
 Weight 9.9 oz.

Recommended Engines
 A8-3 B6-2 (First flight) B6-4 C6-5
 (4 engines required. All must be the same type.)
 EST-1229 \$13.95 GF12.95

PQ 5

Beautiful SCALE KITS

ESTES PERSHING-1A

PQ 3

Specifications
 Length 41"
 Diameter 3.938"
 Weight 11.5 oz.

Recommended Engine

D12-3 EST-1268 \$15.95 GF14.95

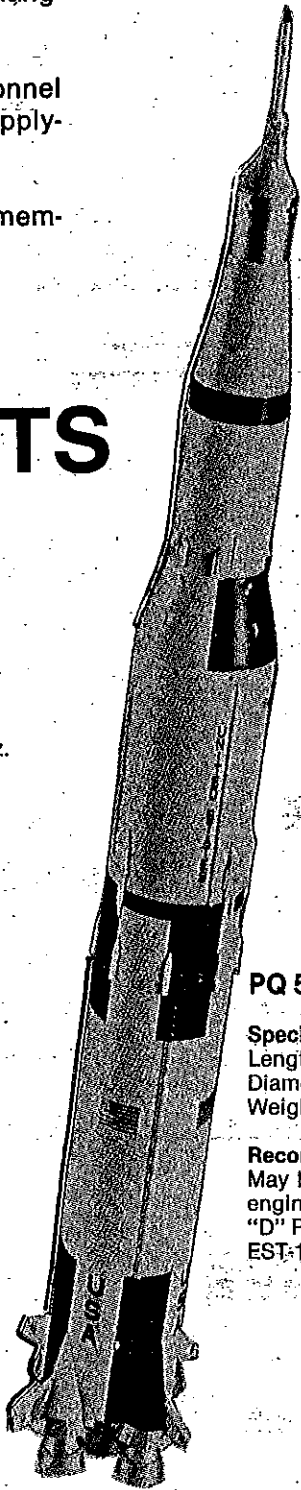
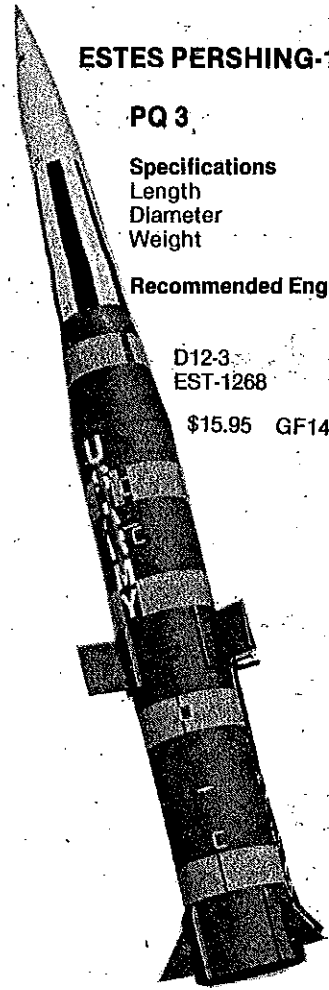

ESTES SATURN V

PQ 5

Specifications
 Length 43.5"
 Diameter 3.938"
 Weight 9.9 oz.

Recommended Engines
 May be flown as 3 engine cluster or single engine. Cluster Power: C6-3 (3 required) "D" Power: D12-3 (1 required)
 EST-1236 \$19.95 GF18.50

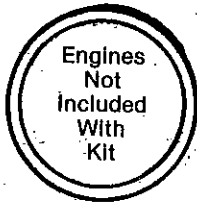

ROCKET PHOTOGRAPHY

ESTES CAMROC

Specifications
 Lens opening — f/16
 Shutter speed — 1/1600 sec.
 Focal length 3" (76mm)

Single exposure film negative 1 1/2" dia. Print 3" diameter.

Fits Estes body tube BT-50. In kit form with all parts and assembly instructions. Comes with 1 loaded film holder plus unexposed film disk for practice loading and experimenting.
 EST-1409 \$8.95 GF7.95

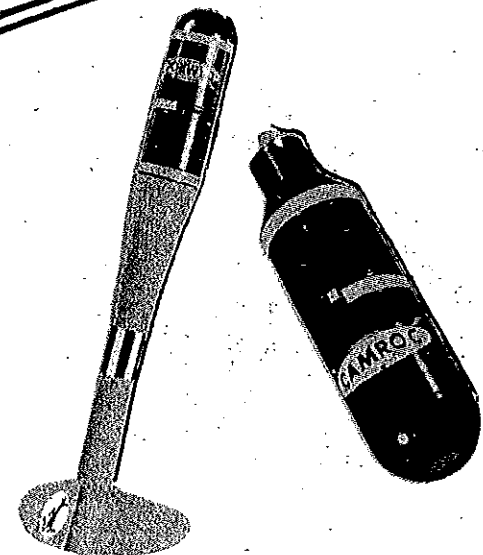

ESTES MODEL ROCKET MOVIE CAMERA

PQ 5

Camera Specifications

10mm focal length lens, f/11 aperture, 1/500 second/31fps shutter, 31 frames per second, 6" to infinity depth of field. Takes color film.

Diameter 1.75"
 Length 9.9"
 Fits Estes BT-60 Body Tube

Fully loaded, the Cineroc Super-8mm aerial movie camera weighs only 3 ounces. Comes completely assembled with Flight-Pak loaded with color film, 2 batteries, and 18" parachute.
 EST-1412 \$29.95 GF26.95

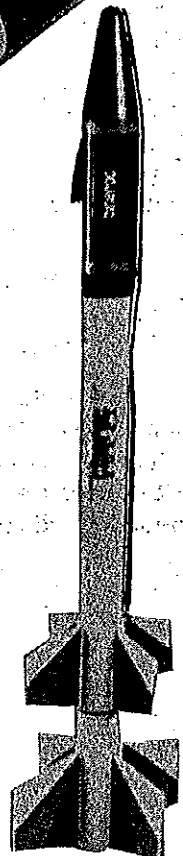

LOOKING TO THE FUTURE

ESTES
FROM **AVI**
astroport
MINERAL POINT, WI. 53565

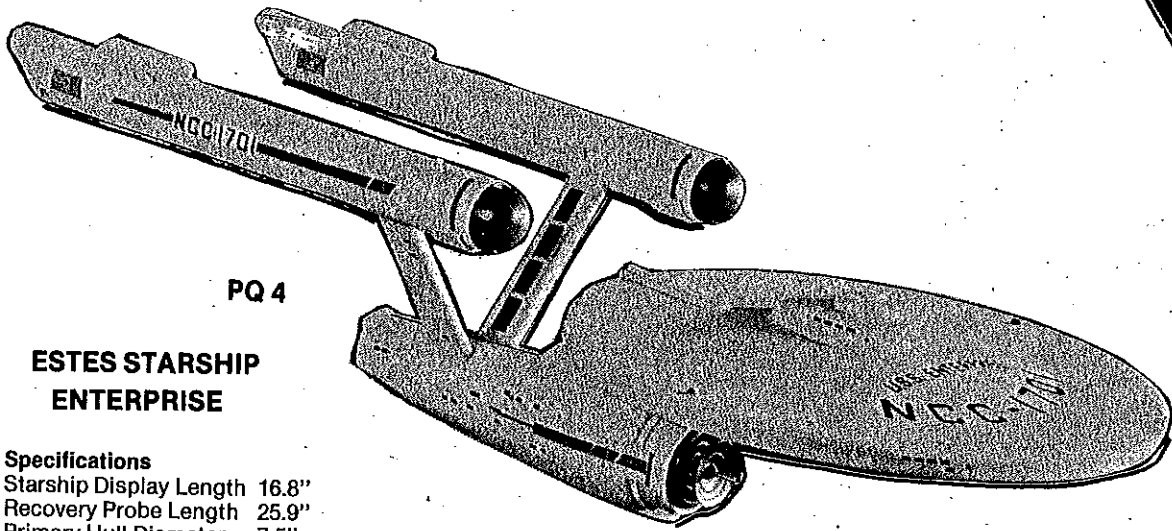

PQ 4

ESTES STARSHIP ENTERPRISE

Specifications
Starship Display Length 16.8"
Recovery Probe Length 25.9"
Primary Hull Diameter 7.5"
Weight 3.8 oz.

Recommended Engines
B6-2 (First flight) C6-3
EST-1275 \$7.95 GF7.25

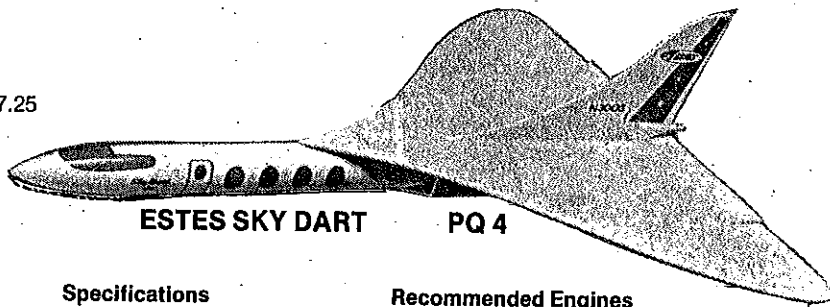

ESTES SKY DART PQ 4

Specifications
Wing Span 12.6"
Length 15.8"
Body Diameter .976"
Weight 1.25 oz.
Weight w/pod 2.5 oz.

Recommended Engines
A8-3 B4-2 B6-2 C6-3
EST-1257 \$5.95 GF5.50



ESTES ANDROMEDA

PQ 3

Specifications
Length 43.3"
Diameter 0.736"
Fin Span 11.8"
Weight 3.0 oz.

Recommended Engines
B6-4 (First flight) C6-5
EST-1273 \$5.95 GF5.50

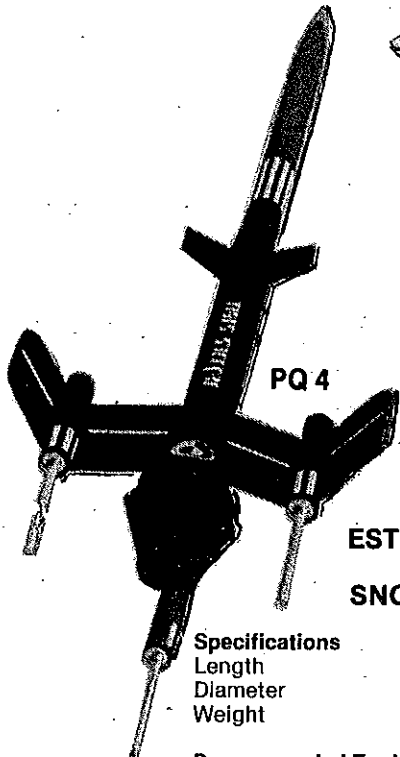

PQ 4

ESTES MARS SNOOPER II

Specifications
Length 22.3"
Diameter 0.976"
Weight 2.3 oz.

Recommended Engines
A8-3 (First flight) B4-2 B6-4 C6-5
EST-1220 \$4.95 GF4.50

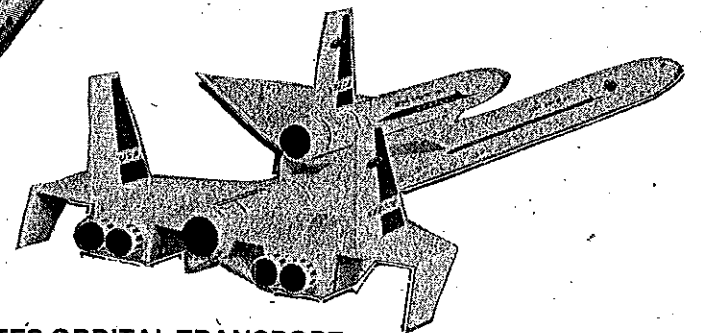

ESTES ORBITAL TRANSPORT

Transport Ship		Re-Entry Vehicle	
Length	23"	Length	8.6"
Diameter	0.976"	Diameter	0.736"
Wing Span	7.9"	Wing Span	5"
Weight	2 oz.	Weight	0.5 oz.

Recommended Engines
B6-2 B6-4 (First flight) C6-5
EST-1242 \$4.95 GF4.50

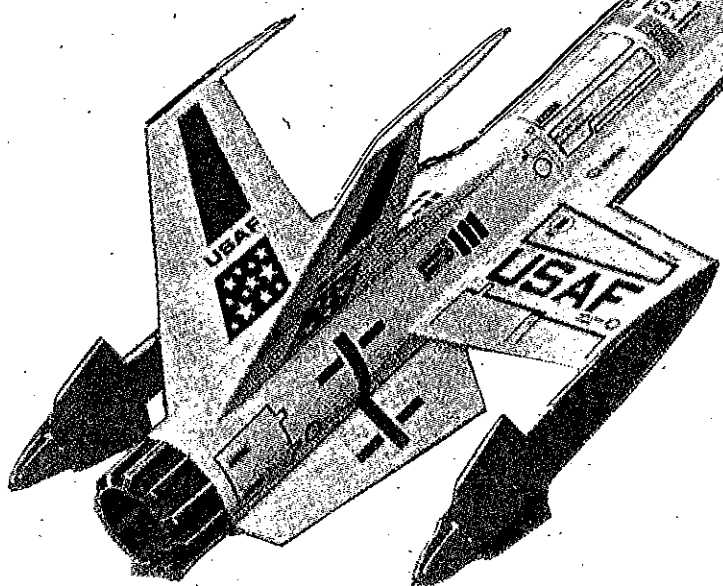

ESTES INTERCEPTOR

PQ 3

Specifications
Length 26"
Wing Span 7.4"
Diameter 1.325"
Weight 3.85 oz.

Recommended Engines
B4-2 B6-4 (First flight) C6-5
EST-1250 \$7.95 GF7.50



ESTES SCISSOR-WING TRANSPORT PQ 3

Specifications
Length 22.75"
Body Diameter 0.976"
Wing Span 16"
Weight w/pod 2.5 oz.
Weight w/o pod 1.8 oz.

Recommended Engines
B4-2 (First flight) B6-2 C6-3
EST-1265 \$5.95 GF5.50

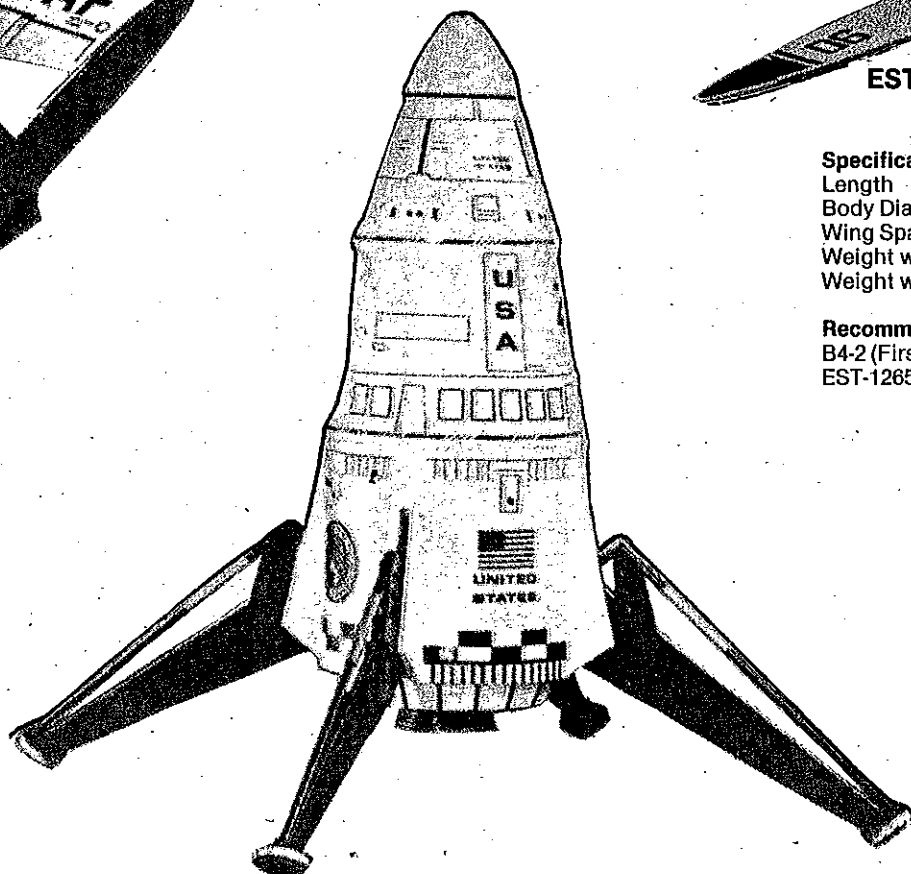

ESTES MARS LANDER

PQ 5

Specifications
Height 12"
Diameter 3.8"
Landing Gear Span 13.2"
Weight 3.0 oz.

Recommended Engines
B4-2 (First flight) B6-2 C6-3
EST-1243 \$9.95 GF9.25

Engines Not Included With Kit

ESTES FLYING ROCKET KITS

Kit Number	Description	Length (Inches)	Diameter (Inches)	Launch Weight (Ounces)	Recommended Engines	Standard Price	GF Price	PQ
EST-1200	Omega Carrier vehicle for the Cineroc movie camera. Two stage D performance, plastic nose and die-cut fins. Tumble recovery on booster and 18" parachute on upper stage. Camera not included.	30.5	1.637	4.0	D12-0 + D12-7	\$7.95	\$7.50	3
EST-1201	Astron Scout Estes original design, tumble recovery, developed in 1959 and still a high flyer.	7	0.765	0.3	1/2 A6-2, A8-3, B6-4, C6-5	\$1.25	\$1.15	1
EST-1202	Astron Mk 2 Midbody separation for recovery by streamer. Good beginner kit.	9.1	0.765	0.7	1/2 A6-2, A8-3, B6-4, C6-5	\$1.75	\$1.60	1
EST-1204	Astron Streak Feather light and nimble kit to reach for the clouds.	5.6	0.720	0.1	1/2 A6-4, A8-5, B6-6, C6-7	\$0.89	\$0.80	1
EST-1205	Apogee II Two-stage with clear payload section, 10" pre-assembled parachute and tech report on multi-staging.	14.7	0.736	0.6	1/2 A6-0 + A6-4, B6-0 + B6-6	\$2.95	\$2.65	3
EST-1207	Phantom A must for displays explaining model rockets, shows internal details.	12.6	0.976 (Static demonstration with cut-away motor)			\$2.95	\$2.65	2
EST-1208	Sky Hook A great kit for your second rocket. Recovery for 12" parachute.	12.0	0.765	0.7	1/2 A6-2, A8-3, B6-6, B4-4, C6-7	\$1.95	\$1.75	1
EST-1211	Wac Corporal Scale 1/16, simple to build, die-cut fins and 12" parachute.	11.8	0.736	0.7	1/2 A6-2, A8-3, B6-4, C6-5	\$2.25	\$2.00	2
EST-1212	Farside Three stages... high altitude probe. Cargo compartment, tech report on staging, tumble recovery on two lower stages and 12" parachute to bring top stage back.	21.5	0.976	2.0	B14-0 + 1/2 A6-0 + 1/2 A6-4	\$3.95	\$3.50	3
EST-1214	Drifter Swept fin design and choice of 24" or 12" chutes for flying, both included.	14.3	0.976	1.1	1/2 A6-2, A8-3, B6-4, C6-5	\$2.95	\$2.75	3
EST-1217	Aerobee 300 Scale 1/15, authentic scale decals, 12" parachute, balsa detailing	20	0.976	0.9	1/2 A6-2, A8-3, B6-4, C6-5	\$2.95	\$2.75	3
EST-1218	X-Ray Large see-through payload section, colorful decals, 12" parachute	16.75	0.736	0.7	1/2 A6-2, A8-3, B6-4, B14-5, C6-5	\$2.95	\$2.75	1
EST-1220	Mars Snooper II Die-cut parts, decals, 18" parachute and far future styling	22.3	0.976	2.3	A8-3, B4-2, B6-4, C6-5	\$4.95	\$4.50	4
EST-1222	V-2 Scale 1/49, balsa nose and tail cones, 12" parachute, historic data	11.2	1.325	1.4	1/2 A6-2, A8-3, B6-4, B14-5, C6-5	\$3.95	\$3.50	3
EST-1223	Big Bertha Ideal for demonstration launches, 18" parachute	24	1.637	2.2	A8-3, B4-2, B6-2, B6-4, C6-5	\$3.95	\$3.65	1
EST-1224	Gyroco Helicopter recovery, unique and interesting	9.8	0.736	0.6	1/2 A6-2, A8-3, B6-4, C6-5	\$1.95	\$1.75	3
EST-1225	Astron Alpha Balsa nose cone and fins, 12" parachute for recovery	12.25	0.976	0.8	1/2 A6-2, A8-3, B4-4, B6-4, C6-5	\$1.95	\$1.75	1
EST-1226	ARCAS® Scale 1/3.4, Atlantic Research Corp. sounding rocket, 18" parachute, decals	22.8	1.325	1.4	A8-3, B6-4, C6-5	\$3.95	\$3.75	3
EST-1227	Honest John Detailed scale model 1/24, beautiful flights and 12" chute recovery	13.75	0.976	1.2	1/2 A6-2, A8-3, B4-4, B6-4, C6-5	\$3.50	\$3.20	4
EST-1235	Constellation Sleek single stage payload with clear cargo compartment, 12" parachute	16.2	0.976	1.0	1/2 A6-2, A8-3, B6-4, B14-5, C6-5	\$2.95	\$2.75	3
EST-1237	Scrambler Egg Lifter, payload diameter is 1.796", two 18" parachutes, decals and tech report on clustering	23.5	1.637	2.8	Cluster 3B6-4, 3A8-3, 3B14-5, 3C6-5	\$6.95	\$6.50	3
EST-1238	Avenger Two stage, tumble recovery on booster and 18" colorful chute on top stage	32	1.325	2.7	B6-0 + B6-6, C6-0 + C6-7	\$4.50	\$4.25	2
EST-1239	Saturn V Semi-scale at 1/242, wrap on decal, clear plastic fins and 12" parachute	18.1	1.637	1.9	A8-3, B6-4, C6-5	\$3.95	\$3.60	3
EST-1241	Mercury Redstone Scale model 1/42, great detail of America's first space ship, capsule returns on 12" chute and the main body on 18" chute, decals for detail.	23.5	1.637	2.1	A8-3, B6-4, C6-5	\$4.95	\$4.50	5
EST-1242	Orbital Transport Shuttle concept where transport carries re-entry vehicle aloft and releases it to glide back while the transport returns on a 18" parachute. Three color decal.	23	0.976	2.5	B6-2, B6-4, C6-5	\$4.95	\$4.50	4
EST-1243	Mars Lander Lands on spring loaded landing gear with 13.2" span after descent on 18" parachute, impressive.	12	3.8	3.0	B4-2, B6-2, C6-3	\$9.95	\$9.25	5
EST-1246	Shrike Two stage with transparent payload section, 12" or 18" parachute choice on upper, lower tumble recovery	29.5	0.976	2.25	B6-0 + B6-6, C6-0 + C6-7	\$6.95	\$6.50	3
EST-1247	Cherokee D High flyer, die-cut fins and two color decal, 18" parachute recovery	21.6	1.325	2.75	D12-5, D12-7	\$3.95	\$3.75	2
EST-1248	Bandit Advanced ejection ducting system to deploy 12" chute, USAF decals, die-cut fins, sharp.	25.75	1.325	2.6	A8-3, B4-4, B6-4, B14-5, C6-5	\$5.95	\$5.50	2
EST-1249	Sprint Boat-tailed base, low drag nose cone, die-cut elliptical fins and streamer recovery	13.8	0.976	1.0	1/2 A6-2, A8-3, B14-5, B4-6, B6-6, C6-7	\$2.95	\$2.75	3
EST-1250	Interceptor Exotic and fascinating. Dramatic flights from kit with die-cut balsa parts, 18" chute, and detailed plastic wing pods, tail cone and nose cone, wing span is 7.4 inches.	26	1.325	3.85	B4-2, B6-4, C6-5	\$7.95	\$7.50	3
EST-1251	Sandhawk Scale 1/10, with plastic nose cone with detail, payload section, fins and tail assembly. Also 12" chute for payload section and 18" chute for main rocket.	30.1	1.325	5	D12-5	\$4.95	\$4.65	2
EST-1254	Saros Payload section plus plastic nose cone, adapter, fin unit, 3 color decal and 12" parachute.	22.5	0.976	1.5	A8-3, A8-5, B4-4, B6-4, C6-5	\$4.95	\$4.65	2
EST-1255	Goblin Goes to 1500' with D12-7, then dramatic recovery on 2" wide streamer, die-cut fins, crazy decals	14.32	1.325	2.0	D12-7	\$3.75	\$3.20	3
EST-1256	Alpha III Plastic nose cone and tail fin assembly, roll pattern decal and 12" parachute	12.25	0.976	1.2	1/2 A6-2, A8-3, B6-4, B4-4, C6-5	\$2.95	\$2.75	1
EST-1257	Sky Dart Rocket boost and then into a glide upon separation of 'power-pod' which returns on 12" parachute	15.8	0.976	1.25	A8-3, B4-2, B6-2, C6-3	\$5.95	\$5.50	4
EST-1258	A-20 Demon Silver foil press on decals, die-cut fins, 18" parachute	26.5	1.325	2.75	D12-7	\$5.95	\$5.50	2
EST-1265	Scissors-Wing Transport Die-cut parts and two color decal, 16" wing swings into position, unique.	11.75	0.976	2.5	B4-2, B6-2, C6-3	\$5.95	\$5.50	3
EST-1266	Camroc Carrier Camera not included, payload section and nose cone ls, die-cut fins, decals, 12" chute	17.75	1.634	0.81	B6-6, B14-7, C6-7	\$3.50	\$3.25	3
EST-1270	Nike-X Scale-like single stage model with Army decor, die-cut fins, 18" parachute, decals	23.4	1.325	2.3	A8-3, B6-4, B4-4, C6-5	\$4.95	\$4.65	2
EST-1271	Renegade Big! Big! Big! Test vehicle appearance, die-cut fins, decals, 18" chute	33.8	1.325	4.6	D12-5	\$4.95	\$4.50	2
EST-1272	Estes Vostok Semi-scale, profile model at 1/76. Russian decor and an 18" parachute.	19.75	1.325	2.4	A8-3, B4-4, B6-4, C6-5	\$4.95	\$4.50	3
EST-1273	ANDROMEDA Starship of the future. Detailed decal, die-cut parts, 18" chute recovery	43.3	0.736	3.0	B6-4, C6-5	\$5.95	\$5.50	3
EST-1274	Klignon Battle Cruiser Wing span 8.9". Molded plastic and die-cut parts, decals and parachute	15.1	---	2.5	B4-2, B6-4, C6-5	\$6.95	\$6.25	4
EST-1275	Starship Enterprise Recovery probe is installed for flight to carry 18" parachute. Detailed plastic parts, full-color starship decals, die-cut parts.	16.8 25.9	---	3.8	B6-2, C6-3	\$7.95	\$7.25	4
EST-1276	Antares Fin and roll pattern decals, plastic nose, die-cut balsa parts, parachute	14.6	0.976	0.77	1/2 A6-2, A8-3, B6-4, C6-5	\$2.50	\$2.25	1
EST-1277	Icarus See through payload, 12" parachute, plastic nose cone, balsa parts	20.8	0.976	1.3	1/2 A6-2, A8-3, B6-4, C6-5	\$2.95	\$2.65	1
EST-1278	Vigilante Two stage, 18" chute, name decal, plastic nose and die-cut balsa fins	26.5	1.325	2.25	A8-0 + A8-5, B6-0 + B6-6	\$4.95	\$4.50	2
EST-1279	NIKE AJAX Scale 1/12.4, authentic U.S. Army decor, 18" parachute, balsa fins	31.25	1.325	2.6	A8-3, B6-4, C6-5	\$5.95	\$5.35	3
EST-1280	Firefly Hitchkikes on rocket (not included), 4.5" wing span	12	---	0.16		\$1.25	\$1.10	2
EST-1281	INVADER Unusual decals, balsa parts, plastic nose cone, 12" parachute	20.5	0.976	1.62	A8-3, B6-4, C6-4	\$3.95	\$3.65	3
EST-1282	Photon Disruptor Star fleet candidate, special decals, 12" parachute, plastic nose	18.25	0.976	1.4	A8-3, B6-4, C6-5	\$2.95	\$2.75	2
EST-1283	USS Atlantis Colorful decals, way-out design	23.3	0.976	1.86	A8-3, B6-4, C6-5	\$4.95	\$4.60	3

ESTES FLYING ROCKET KITS

Kit Number	Description	Length (Inches)	Diameter (Inches)	Launch Weight (Ounces)	Recommended Engines	Standard Price	GF Price	PQ
EST-1229	Updated Saturn IB 1/70 this model is a challenge. Detailed flying model or NASA workhorse. Four-engine cluster power, NASA decor, molded plastic and die-cut balsa parts, dual 24" chutes for main body and 12" chute for the Apollo capsule. Technical report by Estes on cluster engine techniques included.	37	3.938	9.9	4B6-2, 4C6-5, 4A8-3	\$13.95	\$12.95	5
EST-1236	Saturn V Scale 1/100, impressive model of vehicle that took first men to the moon. Plastic details, corrugated wrap-ons and decals. Die-cut parts, Apollo capsule returns on 12" chute and main body on dual 24" chutes. Estes technical report on cluster engine operation included. Remember — PQ 5.	43.5	3.938	9.9	3C6-3 or 1D12-3	\$19.95	\$18.50	5
EST-1267	German V-2 Maxi-brute 1/19 scale model of early rocket. Detailed plastic nose cone, and pre-shaped fins. Fly from a 3/16" diameter 3 foot rod for best results. Historical booklet included. Dual 24" chutes.	33.5	3.938	12.5	D12-3	\$15.95	\$14.95	3
EST-1268	Pershing 1A 1/10 scale, USAF surface to surface missile is recovered on dual 24" chutes. Pre-shaped fins and other detail, molded plastic nose cone. Historical background data included. Launch from 3/16 inch rod.	41	4.938	11.5	D12-3	\$15.95	\$14.95	3
EST-1269	Honest John Scale. Launch from a 3/16" rod. Molded pre-shaped nose cone, fins and dual 24" parachutes. Additional information is included in historical data pack. Great for demonstrations.	37	2.6	14	D12-3	\$15.95	\$14.95	3
EST-0801	Mosquito Smallest of the Estes Mini-Bruces. Balsa nose and fins, flutter recovery.	3.9	0.541	0.1	1/4 A3-2T, 1/2 A3-4T, A3-6T, A10-3T	\$0.79	\$0.75	1
EST-0802	Screamer Estes super performer, with streamer recovery.	7.8	0.541	0.255	1/4 A3-2T, 1/2 A3-4T, A3-6T, A10-3T	\$1.75	\$1.60	1
EST-0803	Mini-Bertha Two color decal sheet, balsa and paper construction, colorful 10" parachute.	11.25	0.736	0.484	1/2 A3-2T, A3-4T, A10-3T	\$1.95	\$1.80	1
EST-0805	Mini-Bomarc Scale model with decals for Canadian Air Force markings. Die-cut parts and 8" parachute.	11.75	0.737	1.0	1/2 A3-2T, A3-4T, A10-3T	\$3.25	\$3.00	3
EST-0815	Javelin & Super Flea Combo Kit. The two kits in a single package for only \$2.10. High flyers...	12.4 7.34	0.541 0.541	0.34 0.158	1/4 A3-2T, 1/2 A3-2T, A3-4T 1/4 A3-2T, 1/2 A3-4T, A3-4T, A10-3T	\$2.25	\$2.10	1
EST-0816	Woverine Futuristic Russian hypersonic design. Realistic 12" parachute, Russian appearing decals.	11.25	0.976	0.875	1/2 A3-2T, A3-4T, A10-3T	\$2.50	\$2.35	3
EST-0818	Rogue Decals give research vehicle appearance. Die-cut balsa parts, 10" parachute.	11.7	0.736	0.75	1/4 A3-2T, 1/2 A3-2T, A3-4T	\$1.95	\$1.75	1
EST-0819	Little John US Army appearance. Die-cut fins and 12" parachute for recovery.	14.0	0.976	0.875	1/2 A3-2T, A3-4T, A10-3T	\$2.25	\$2.10	1
EST-0831	Star Blazer Looks like futuristic space reconnaissance vehicle. USAF decals and 10" parachute.	11.5	0.736	0.73	1/4 A3-2T, 1/2 A3-2T, A3-4T, A10-3T	\$2.95	\$2.75	3
EST-0845	Beta Two stage for sky piercing flights. First stage tumble recovery and upper stage returns on 10" chute.	13.76	0.736	0.75	1/4 A3-0T + 1/4 A3-2T, A10-0T + A3-6T	\$1.95	\$1.80	2

ESTES ROCKETRY STARTER SETS

EST-1418	Estes STAR TREK Starter Kit	\$9.95	\$9.35	1
EST-1407	Delux Estes Starter Kit	\$12.95	\$11.95	1
EST-0701	Estes Firing Line Mini-Starter Set Kit	\$14.95	\$13.95	1
EST-0655	Estes Citation Starter Kit	\$14.95	\$14.25	1

ESTES ACCESSORIES

EST-1409	C-1 Camroc Take photographs with your rocket. Camera comes in kit form. Includes 1 loaded film holder plus unexposed film disk for practice loading. Model Rocketry's first aerial camera from Estes.	\$8.95	\$7.95	4
EST-1411	Loaded film holder for the Camroc. Four loaded holders.	\$3.95	\$3.50	4
EST-1412	Cineroc Take movies as your rocket carries aloft. Comes assembled with flight pack loaded with color film, 2 operations batteries and 18" parachute. Another first from Estes.	\$29.95	\$26.95	5
EST-1414	Flight Pak Film - 10 feet of color super-8 and 2 PFB-2 batteries (good for one flight) Processing is \$2.00 extra.	\$4.95	\$4.50	5

ESTES STANDARD 18x70 ROCKET ENGINES

Cat. No.	Engine Type	Prices 3 for	Total Impulse n-sec.	Time Delay (Sec.)	Max Lift Lift Wt. (Ounce)	Max. Thrust (Ounce)	Thrust Duration (Sec.)	Initial Weight (Grams)	Propellant Weight (Grams)
SINGLE STAGE ENGINES (GREEN LABEL)									
EST-1593	1/2 A6-2	\$1.25	1.25	2	2.5	48	0.20	15.0	1.56
EST-1598	A8-3	\$1.35	2.50	3	4.0	48	0.32	18.2	3.12
EST-1601	B4-2	\$1.45	5.00	2	4.0	48	1.20	19.8	8.33
EST-1602	B4-4	\$1.45	5.00	4	3.5	48	1.20	21.0	8.33
EST-1605	B6-2	\$1.45	5.00	2	4.5	48	0.83	19.3	6.24
EST-1606	B6-4	\$1.45	5.00	4	4.0	48	0.83	22.1	6.24
EST-1609	B14-5	\$1.65	5.00	5	5.0	7 lb.	0.35	19.5	6.24
EST-1613	C6-3	\$1.65	10.00	3	4.0	48	1.70	24.9	12.48
EST-1614	C6-5	\$1.65	10.00	5	4.0	48	1.70	25.8	12.48
EST-1594	1/2 A6-4	\$1.25	1.25	4	1.0	48	0.20	15.3	1.56

UPPER STAGE ENGINES (PURPLE OR BLUE LABEL)

EST-1599	A8-5	\$1.35	2.50	5	2.0	48	0.32	17.8	3.12
EST-1604	B4-6	\$1.45	5.00	6	1.5	48	1.20	22.1	8.33
EST-1607	B6-6	\$1.45	5.00	6	2.0	48	0.83	20.1	6.24
EST-1611	B14-7	\$1.65	5.00	7	2.5	7 lb.	0.35	20.7	6.24
EST-1615	C6-7	\$1.65	10.00	7	2.5	48	1.70	26.9	12.48

BOOSTER ENGINES (RED LABEL)

EST-1595	1/2 A6-0	\$1.25	1.25	none	4.0	48	0.18	
----------	----------	--------	------	------	-----	----	------	--

FLYING ROCKET KITS

FROM
AVI ASTROPORT

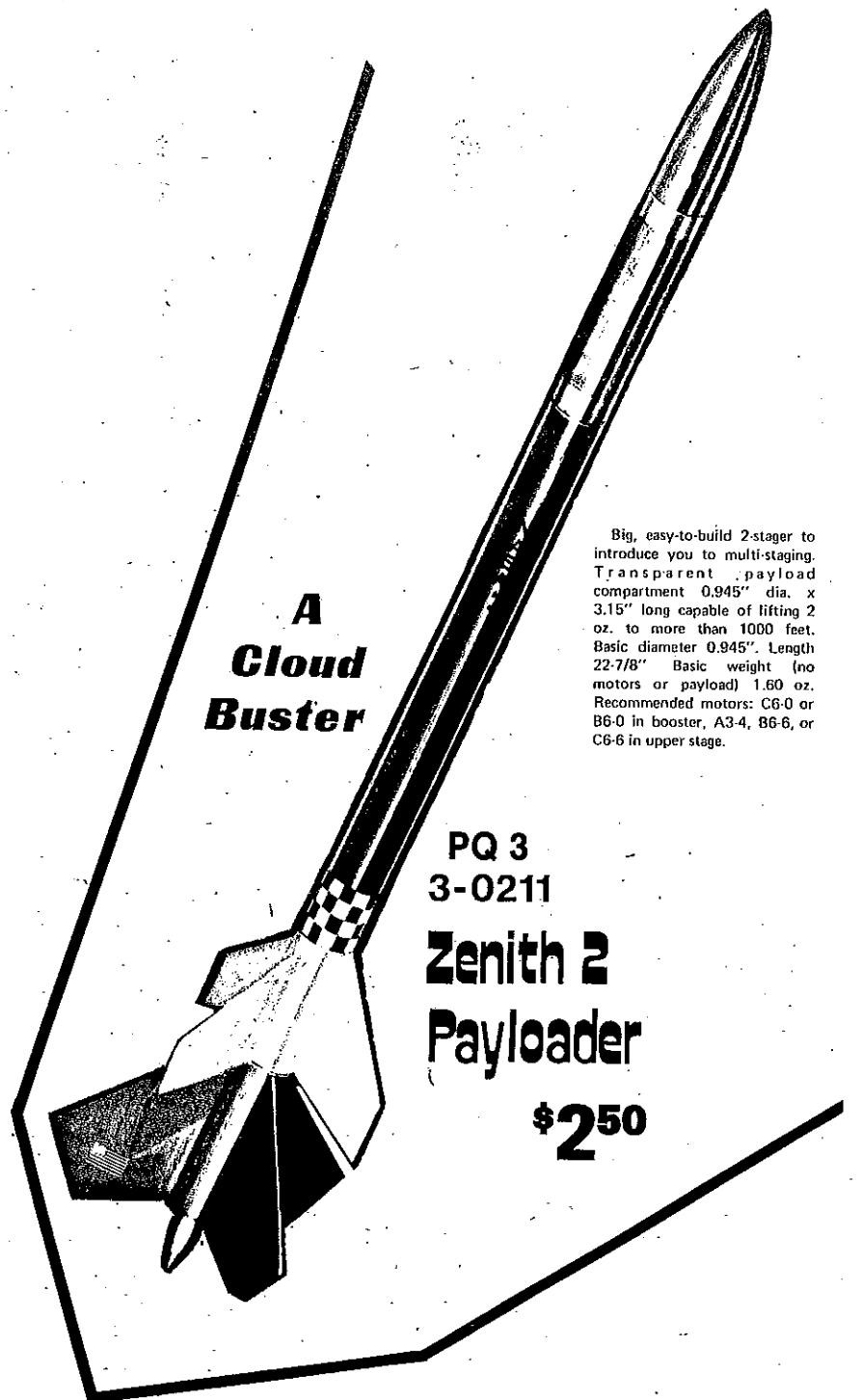

**A
Cloud
Buster**

Big, easy-to-build 2-stager to introduce you to multi-staging. Transparent payload compartment 0.945" dia. x 3.15" long capable of lifting 2 oz. to more than 1000 feet. Basic diameter 0.945". Length 22-7/8". Basic weight (no motors or payload) 1.60 oz. Recommended motors: C6-0 or B6-0 in booster, A3-4, B6-6, or C6-6 in upper stage.

PQ 3
3-0211
**Zenith 2
Payloader**
\$250

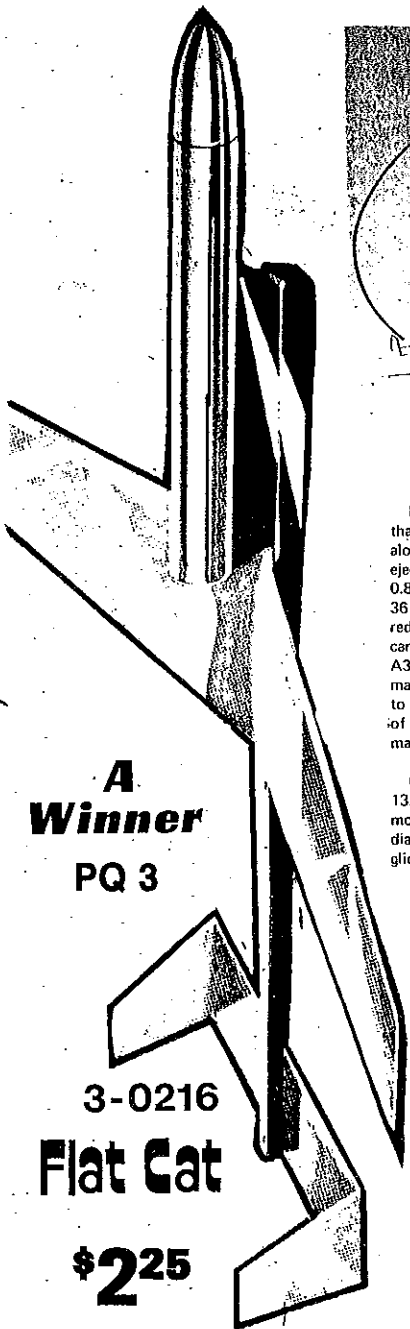

**A
Winner**
PQ 3

3-0216
Flat Cat
\$225

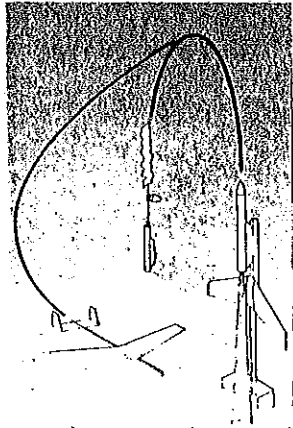

Flat Cat has a booster pod that pulls the all-balsa glider aloft, detaching at streamer ejection. Gliding weight is 0.81 oz. with a wing area of 36 sq. in. Experts have reduced this weight in half by careful streamlining. With an A3-2 engine, Flat Cat should make a flight of 45 seconds to one minute. Contest flights of over 6 minutes have been made using the B3-3 motor.

Other specs: Wing span: 13.75". Liftoff weight (no motor): 1.095 oz. Pod diameter: 0.788". All balsa glider.

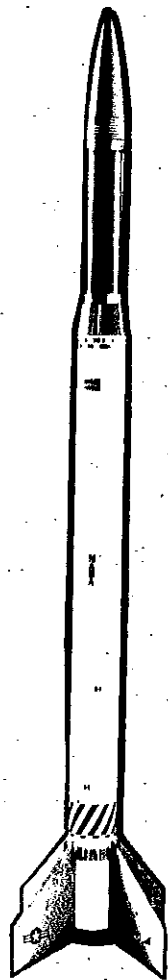

**A
Biggy**

"Ignition! We have a lift-off!" The huge rocket strains to leave the pad, then moves skyward as thrust is converted into velocity. Aquarius is on its way! This is the Big Bird from AVI! Then the 14" chute brings it home for a perfect landing. It's got a payload section capable of carrying an ounce of payload on a skyward mission. The nose cone, transition coupler, and clip-on tail fins are high-impact plastic for easy assembly. Aquarius is a biggy with plenty of room for chutes, payload, and customizing parts. Diameter: 1.171". Length: 23.5". No-motor weight: 1.585 oz. Recommended motors: B3-3, B6-4, and C6-4.

3-0845
PQ 2

Aquarius
\$165

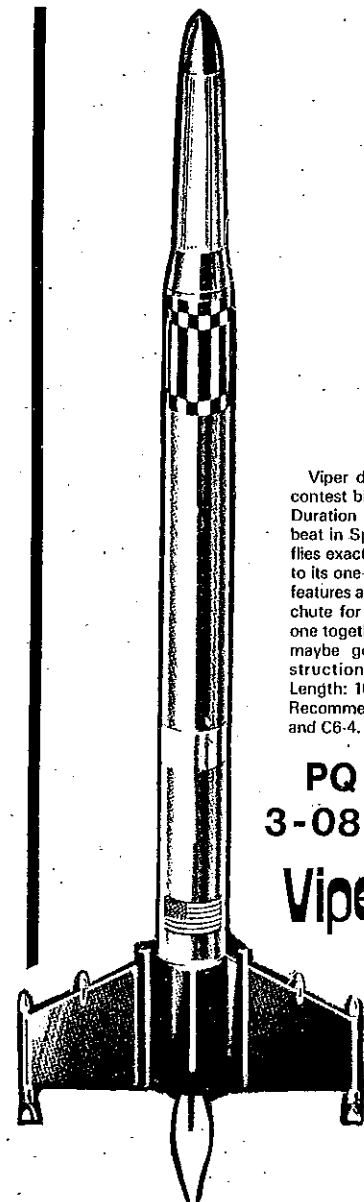

**A
Snap**

Viper doesn't look it, but it's a great contest bird for small fields in Parachute Duration competition. And it's hard to beat in Spot Landing contests because it flies exactly the same way every time due to its one-piece cruciform fin assembly. It features an all-plastic nose cone and a 10" chute for recovery. If you can't put this one together and get it to fly, you should maybe go back to crayons and construction paper. Diameter: 0.984". Length: 16". No-motor weight: 1.375 oz. Recommended motors: A3-2, B3-3, B6-4, and C6-4.

PQ 1
3-0823
Viper

\$150

In 1965, G. Harry Stine began the development of a beginner's boost-glider. In 1968, the Flat Cat was born. In 1970, it became a kit. Flat Cat is the most universal boost-glider design ever, ideal for research, efficient for competition, and easy for the beginner. Thousands have been built and flown all over the world.