

# YESTERDAY and TOMORROW

## Mercury- Redstone by

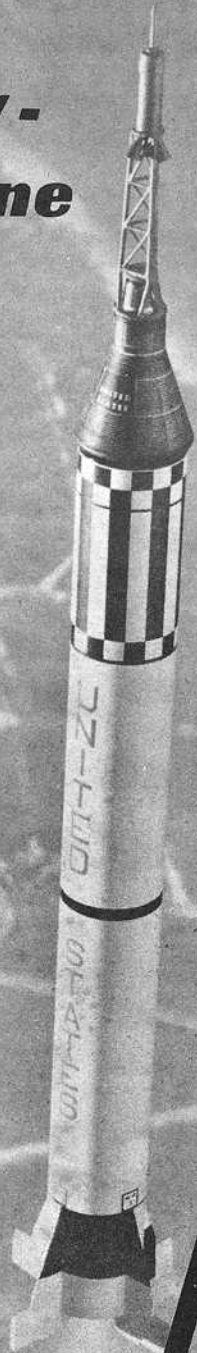

# NEW

## Historic Scale Model

Only  
**\$2.<sup>75</sup>**

### RECOMMENDED ENGINES

A8-3 B6-4 C6-5

### SPECIFICATIONS

Length 23-1/2 in.  
Body Dia. 1.637 in.  
Weight 2-1/8 oz.

### DUAL PARACHUTE RECOVERY

A beautiful rocket to thrill even the most advanced rocketeer, the Mercury Redstone is an exact scale model of the vehicle that boosted Commander Alan Shepard on America's first manned ballistic space flight. Scaled at 1 to 42, the model is accurately detailed and includes a complete decal sheet. Although it requires care and precision in construction, the completed model will become one of your favorite rockets. Shipping weight 16 oz.

CAT. NO. 683-K-41

Based on the latest proposals for a reusable, air breathing (scramjet) booster stage for orbital vehicles, the Orbital Transport gives you a look at the launch vehicle of 1985. Realistic in appearance and operation too, the Transport lifts off under rocket power just like the big one would. At ejection the model's "reentry vehicle" separates and glides back; the booster returns by parachute. Kit comes complete with colorful decal and an explanation of the principles and proposals for air breathing boosters. Shipping weight 16 oz.

CAT. NO. 683-K-42 ONLY \$2.50



## ORBITAL TRANSPORT



RECOMMENDED ENGINES  
B6-4 C6-5

### SPECIFICATIONS

BOOSTER	REENTRY VEHICLE
23.0 in. LENGTH	8.6 in.
7.9 in. WINGSPAN	6.0 in.
2.0 oz. WEIGHT	0.5 oz.
0.976 in. Body Dia.	0.736 in.

**Futuristic Design  
Releases Glider in Flight**



# TWO SPECIAL ROCKETS

## Astron scrambler

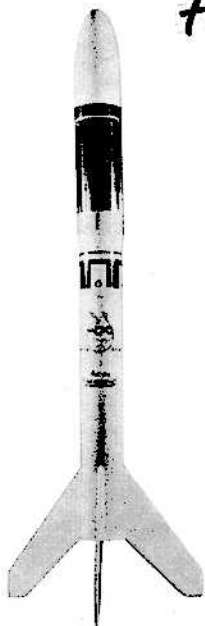

Huge, see-through payload compartment holds an egg or other large payload--cluster design gives the power to boost it. A great sport model that's perfect for contests, too. Has 2 'chutes for extra gentle recovery, can carry an egg to over 1000 feet and set it down safely. Comes with all parts, instructions, a complete technical report on clustering and a colorful decal sheet for easy decorating. Shipping weight 13 oz.

Cat. No. 682-K-37  
Only \$3.00

#### SPECIFICATIONS:

LENGTH 23.5 in.  
WEIGHT 2.8 oz.  
BODY DIA. 1.637 in.  
PAYLOAD DIA. 1.796 in.

#### RECOMMENDED ENGINES

A8-3, B6-4, C6-5, B14-5

#### SPECIFICATIONS:

BODY DIA. 1.325 in.  
LENGTH 32 in.  
WEIGHT 2.7 oz.

## Astron Avenger

2-STAGE ROCKET

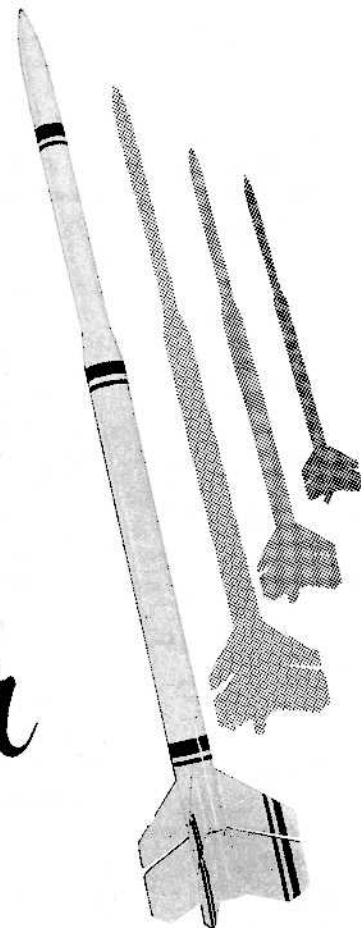

#### RECOMMENDED ENGINES

BOOSTER: A8-0, B6-0,  
B14-0, C6-0  
UPPER STAGE: A5-4,  
B6-6, C6-7

## A Scale to Weigh Your Birds

No More  
Guesswork!

Weigh each part  
or a whole bird...  
up to 9 ounces!

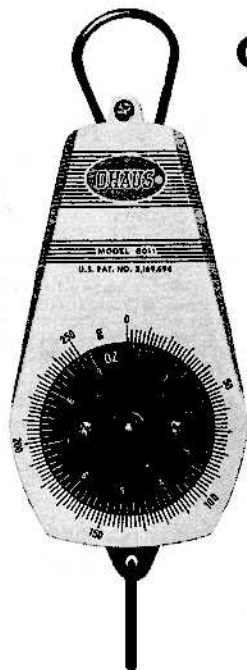

Only \$2.75

Tired of guessing how much your birds weigh? Here's a scale that's perfect for general purpose use by the rocketeer. Calibrated in both grams and ounces, it's accurate to within 2 grams at full load. To weigh a rocket, just slip the hook into the launch lug. For weighing parts that won't fit on the hook a pan can be improvised. Scale comes complete with instructions. Shipping weight 5 oz.

Cat. No. 683-WS-1 Only \$2.75 each

Long slender lines give this bird the appearance of a sounding rocket. With 2-stage capabilities, it is an exciting sport and demonstration rocket...with or without payload. Designed to take advantage of the thrust capabilities of the C engines, it will give great flights time after time. 18" parachute brings it back gently. First stage flutters in softly. Comes with all parts, instructions and a complete technical report on staging. (Engines not included.) Shipping weight 16 oz.

CAT. NO. 682-K-38

ONLY  
\$2.75

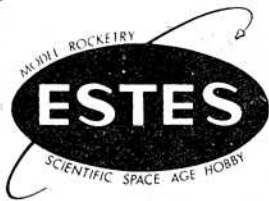

**FREE  
KITS!**

Receive one of these bonus kits free with your \$5 or \$10 order as our "Thank-You." When you place a larger order at full retail price you are entitled to receive a combination of free kits just as though you had placed a number of \$5 or \$10 orders.

**SATURN V**

**SEMI-SCALE  
ROCKET**



**SPECIFICATIONS**  
Length 18.1 in.  
Body Dia. 1.637 in.  
Weight 1.87 oz.

**\$2.50**  
Value

The perfect high performance bird for single stage payload work or just flying for fun. The long slender lines and the "landing shocks" at each fin tip lend the appearance of a space vehicle of the future. Parachute recovery, "see-through" payload section plus a quick change engine mount make the Constellation easy to fly and reliable. Kit comes complete with all parts and instructions (but no engines). Shipping weight is 6 oz.

**SINGLE-STAGE PAYLOAD ROCKET**

**ASTRON  
Constellation**

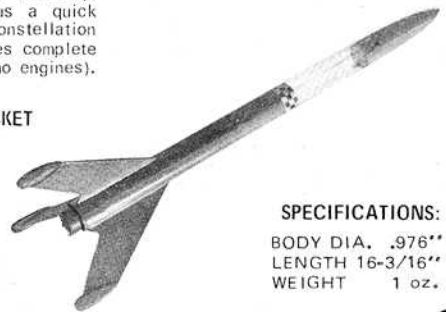

**SPECIFICATIONS:**  
BODY DIA. .976"  
LENGTH 16-3/16"  
WEIGHT 1 oz.

**RECOMMENDED ENGINES**  
1/2A6-2, A8-3, A5-4,  
B6-4, C6-5

**Your choice with  
\$10 order**

Though not fully detailed, this model of the Saturn V is an amazingly good representation of our nation's biggest launch vehicle. Scaled at 1 to 242 it is a practical size to build. With single engine reliability you can count on precise launchings and steady flights. Parachute recovery gives gentle landings. You'll want to fly the Saturn often this year. Instructions and all parts included, but no engines. Shipping weight 13 oz.

**Cat. No. 681-K-35**  
**\$2.00 Value**

**Astron MIDGET**

**Series III  
Engines**

**SPECIFICATIONS**  
Length 9.25 in.  
Body Dia. 0.976 in.  
Weight 0.56 oz.

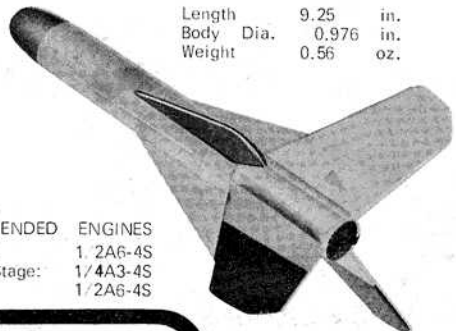

**RECOMMENDED ENGINES**  
Booster: 1.2A6-4S  
Upper Stage: 1/4A3-4S  
1/2A6-4S

**RECOMMENDED ENGINES**

- A8-3
- B6-4
- C6-5

**HELICOPTER  
RECOVERY**

**HIGH  
PERFORMANCE**

**Your choice with  
\$5 order**

**Cat. No. 682-K-40**  
**\$1.25 Value**

**ASTRON GYROC**

Sky-high performance and a unique, dependable recovery system make this model a perfect addition to your rocket fleet. With light weight and streamlined design, the Gyroc soars to amazing altitudes; helicopter recovery brings it back gently, close to the launcher. Shipping weight 5 oz. (Engines not included with kit.)

To receive this kit, write in "FREE GYROC" on the last line of your order form.

**CAT. NO. 671-K-24** **\$1.25 VALUE**

After its first flight you'll decide this unique 2-stage rocket is no midget when performing. Graceful in design and fast at lift off, this high performance model gets the most out of the smaller engines. Upper stage returns by parachute, booster flutters in gently. Uses series III engines (not included). Kit contains all parts and instructions. Shipping weight 6 oz.

**RECOMMENDED ENGINES**  
1/2A6-2, A8-3, B6-4, C6-5

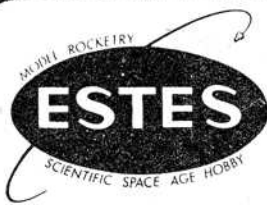

# FREE KITS!

Receive one of these bonus kits free with your \$5 or \$10 order as our "Thank-You." When you place a larger order at full retail price you are entitled to receive a combination of free kits just as though you had placed a number of \$5 or \$10 orders.

## SATURN V

SEMI-SCALE ROCKET



**\$2.50**  
Value

SPECIFICATIONS  
Length 18.1 in.  
Body Dia. 1.637 in.  
Weight 1.87 oz.

Though not fully detailed, this model of the Saturn V is an amazingly good representation of our nation's biggest launch vehicle. Scaled at 1 to 242 it is a practical size to build. With single engine reliability you can count on precise launchings and steady flights. Parachute recovery gives gentle landings. You'll want to fly the Saturn often this year. Instructions and all parts included, but no engines. Shipping weight 13 oz.

RECOMMENDED ENGINES

- A8-3
- B6-4
- C6-5

HELICOPTER RECOVERY



RECOMMENDED ENGINES  
1/2A6-2, A8-3, B6-4, C6-5

## ASTRON GYROC

Sky-high performance and a unique, dependable recovery system make this model a perfect addition to your rocket fleet. With light weight and streamlined design, the Gyroc soars to amazing altitudes; helicopter recovery brings it back gently, close to the launcher. Shipping weight 5 oz. (Engines not included with kit.)

To receive this kit, write in "FREE GYROC" on the last line of your order form.

CAT. NO. 671-K-24 **\$1.25 VALUE**

## ASTRON Constellation

The perfect high performance bird for single stage payload work or just flying for fun. The long slender lines and the "landing shocks" at each fin tip lend the appearance of a space vehicle of the future. Parachute recovery, "see-through" payload section plus a quick change engine mount make the Constellation easy to fly and reliable. Kit comes complete with all parts and instructions (but no engines). Shipping weight is 6 oz.

SINGLE-STAGE PAYLOAD ROCKET



SPECIFICATIONS:  
BODY DIA. .976"  
LENGTH 16-3/16"  
WEIGHT 1 oz.

RECOMMENDED ENGINES  
1/2A6-2, A8-3, A5-4,  
B6-4, C6-5

Cat. No. 681-K-35  
**\$2.00 Value**

**Your choice with \$10 order**

## Astron MIDGET Series III Engines

SPECIFICATIONS  
Length 9.25 in.  
Body Dia. 0.976 in.  
Weight 0.56 oz.

RECOMMENDED ENGINES  
Booster: 1/2A6-4S  
Upper Stage: 1/4A3-4S  
1/2A6-4S

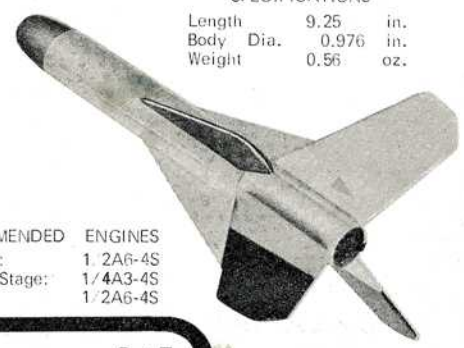

Cat. No. 682-K-40  
**\$1.25 Value**

**Your choice with \$5 order**

HIGH PERFORMANCE

After its first flight you'll decide this unique 2-stage rocket is no midget when performing. Graceful in design and fast at lift off, this high performance model gets the most out of the smaller engines. Upper stage returns by parachute, booster flutters in gently. Uses series III engines (not included). Kit contains all parts and instructions. Shipping weight 6 oz.