



# FLYING MODEL ROCKET KIT

## NOVA sport rocket

- NOSE-EJECTED PARACHUTE!
- LONG BALSA NOSE CONE!
- 2-COLOR STICK-ON "DECALS"!
- PRE-CUT SWEEP Balsa FINS!
- HI-PERFORMANCE LAUNCH "LUGLETS"!

### Kustom Kit

Includes parts for alternate version with rear-ejection streamer.



Motors NOT included

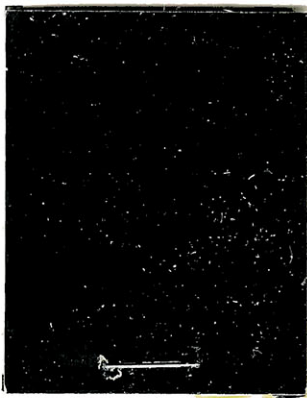

# Mini Rocket

FOR USE WITH CENTURI MINI-MOTORS

Catalog No. **KM-4**

NOVA sport rocket

Mini Rocket



IP-700  
0873

Catalog No. **KM-4**

Centuri

Mini Rocket

NOVA

sport rocket

Catalog No. **KM-4**

Manufactured by Centuri Engineering Co., Phoenix, Arizona

## TOOLS YOU WILL NEED

Here are the ordinary modeling tools & supplies you'll find useful in assembling this kit.

- Superbond Glue (or "white" glue)
- Fil-Cote (or sanding sealer)
- Narrow paint brush
- Spray paint (enamel)
- Scissors & Pencil

# NOVA

## MINI-ROCKET

### MAXIMUM ALTITUDE CHART

ALTITUDES DEPEND GREATLY ON THE PRECISION OF ASSEMBLY AND SMOOTHNESS OF THE SURFACE FINISH. USE LOWER POWER MOTORS (1/4A, 1/2A) FOR FIRST FLIGHTS.

MOTOR	FEET	MOTOR	FEET
1/4A4-2M	250	A4-4M	800
1/2A4-3M	450	B4-5M	1400

A REWARDING HOBBY FOR AGES 10 TO ADULT

**Centuri**

RECOMMENDED AVERAGE AGE  
FOR "NOVA" KIT:

11

TO ADULT

Avoid using the most powerful motors on the first launch. For instance, a "B" motor will fly your rocket so high that you may lose sight of it and be unable to find it again. Or, it may cause, the rocket to recover a great distance away . . . possibly on a roof, or in a tree top. "B" motors are intended for experienced rocketeers, and large launch areas.

## FLIGHT PREPARATION

### CHUTE VERSION (NOSE EJECTION)

1. Inspect shock cord fastener for firm bond.
2. Insert Flameproof Parachute Wadding according to its directions.
3. Tuck in shock cord.
4. Check the chute to be sure the tape discs are on firmly.
5. Fold chute neatly, and insert.
6. Socket nose cone in place.
7. Apply a small amount of masking tape to your Mini-Motor casing . . . just enough to have a good friction fit . . . and insert it into the rocket.
8. Apply a narrow strip of masking tape completely around the exposed end of the motor and end of the rocket.

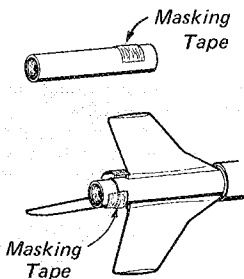

### STREAMER VERSION (REAR EJECTION)

1. Install the Mini-Motor as explained above.
2. Apply a little masking tape onto the centering ring for a good friction-fit.
3. Roll or fold the streamer neatly and insert it into the rear of the body.
4. Insert a modest amount of Flameproof Wadding.
5. Socket the assemblies together checking for neat alignment.

Carefully prepare and check all parts of your rocket before each flight.

Launch the NOVA from any standard model rocket launcher having 1/8" diameter x 36" long steel launch rod.

This rocket is designed to be launched only from standard remote-controlled electrical launch systems. Always use the recommended engines. Comply with all Federal, State, and local laws.

Referring to the specific instructions which accompany Centuri launchers and firing panels, mount the rocket on the launcher and prepare for ignition. Avoid eye injury by capping the exposed tip of the launch rod when not actually launching the rocket.

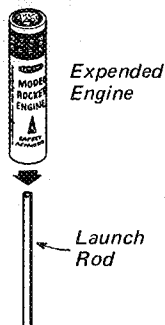

**CENTURI ENGINEERING COMPANY**  
P.O. Box 1988, Phoenix, Arizona 85001

## THE RIGHT MATERIALS FOR THE JOB

PART	REQUIREMENTS	MATERIAL
Fins	Ability to be air-foiled Swept-back shape	Balsa
Nose Cone	Ability to be sanded	Balsa

**Centuri** **NOVA**  
Catalog No. KM-4

## MODEL ROCKETEER'S SAFETY CODE

### CONSTRUCTION

My model rockets will be made of only lightweight materials such as paper, wood, plastic, and thin metallic foils, with the exception of payloads and engine holders made of wirelike material.

### ENGINES

I will use only pre-loaded factory made model rocket engines in the manner recommended by the manufacturer. I will not change in any way nor attempt to reload these engines.

### RECOVERY

I will always use a recovery system in my model rockets that will return them safely to the ground so that they may be flown again.

### WEIGHT LIMITS

My model rocket will weigh no more than 453 grams (16 oz.) at liftoff, and the engines will contain no more than 113 (4 oz.) of propellant, as prescribed by Federal Regulations.

### STABILITY

I will check the stability of my model rockets before their first flight except when launching models of already proven stability.

### LAUNCHING SYSTEM

The system I use to launch my rockets will be remotely controlled and electrically operated, and will contain a switch that will return to "off" when released. I will remain at least 10 feet away from any rocket that is being launched.

### LAUNCH SAFETY

I will not let anyone approach a model rocket on a launcher until I have made sure that either the safety interlock key has been removed or the battery has been disconnected from my launcher.

### LAUNCH AREA

My model rockets will always be launched from a cleared area, free of any easy-to-burn materials, and I will only use non-flammable recovery wadding in my rockets.

### BLAST DEFLECTOR

My launcher will have a blast deflector device to prevent the engine exhaust from hitting the ground directly.

### LAUNCH ROD

To prevent accidental eye injury I will always place the launcher so the end of the rod is above eye level or cap the end of the rod with my hand when approaching it. I will never place my head or body over the launching rod. When my launcher is not in use I will always store it so that the launch rod is not in an upright position.

### POWER LINES

I will never attempt to recover my rocket from a power line or other dangerous places.

### LAUNCH TARGETS AND ANGLE

I will not launch rockets so their flight path will carry them against targets on the ground, and will never use an explosive warhead nor a payload that is intended to be flammable. My launching device will always be pointed within 30 degrees of vertical.

### PRE-LAUNCH TEST

When conducting research activities with unproven designs or methods, I will, when possible, determine their reliability through pre-launch tests. I will conduct launchings of unproven designs in complete isolation from persons not participating in the actual launching.

### FLYING CONDITIONS

I will not launch my model rocket in high winds, near buildings, power lines, tall trees, low flying aircraft or under any conditions which might be dangerous to people or property.

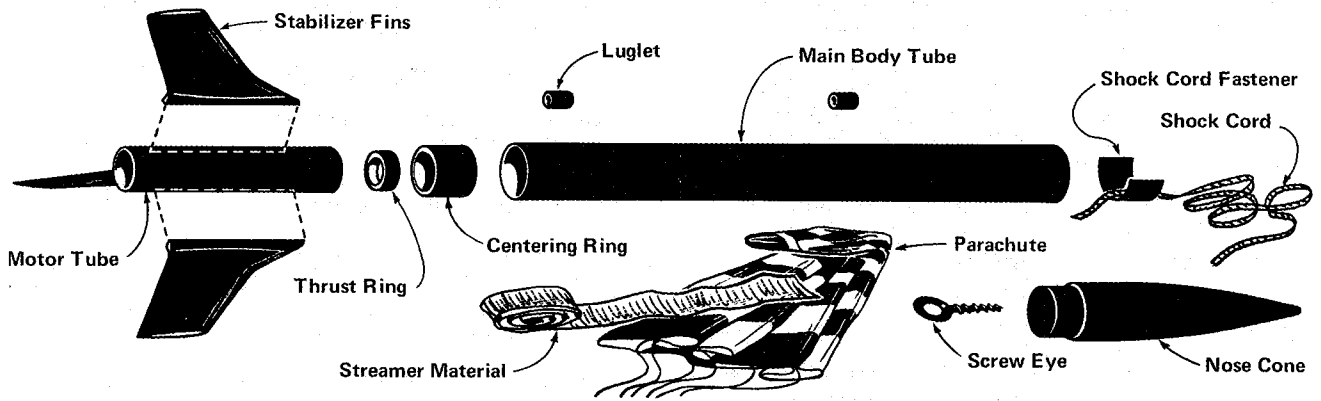

- 7** Insert the assembly into one end of the main body tube (7" long). Make sure it's at least 3/4" into the tube, to allow room for the nose cone to be inserted later. Rub the fastener down firmly with eraser end of pencil, and hold until dry.

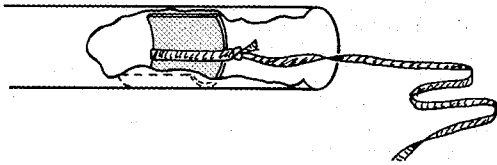

- 10** Glue the centering ring over the end of the motor tube.

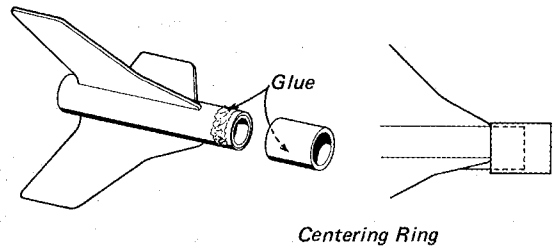

- 8** Tie the other end of the shock cord thru the nose cone screw eye . . . use a double knot. Tie the assembled parachute shroud lines onto the free end of shock cord.

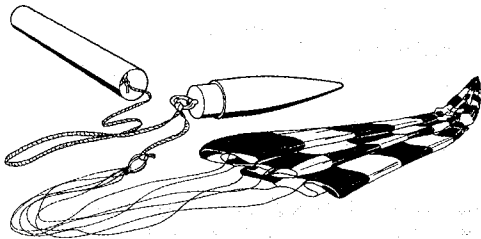

- 9** Apply glue around the inside forward end of motor tube, and around the outside of the thrust ring. Glue the parts together, flush with each other.

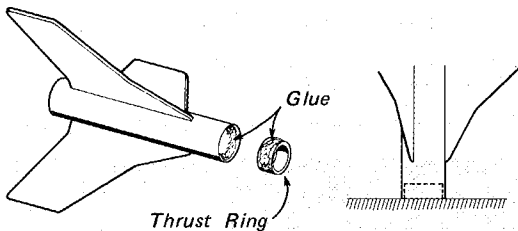

- 11** Glue the lower and upper rocket assemblies together.

NOTE: This step can be saved for later if you want to spray paint each assembly different colors . . . but mask-off the coupler first!

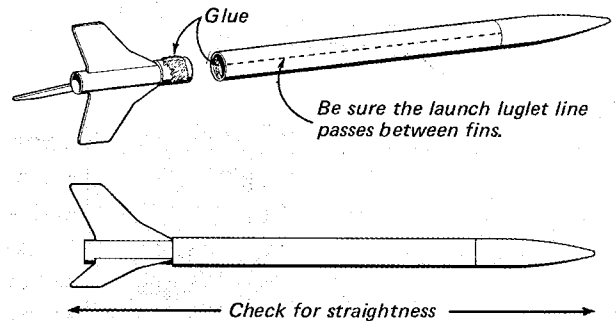

- 12** Glue the two launch luglets along their drawn line as shown . . . use enough glue to be sure they are firmly on.

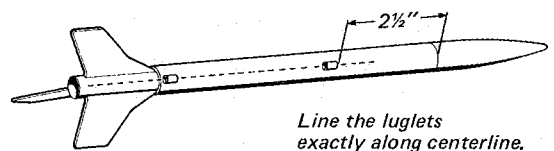

## HOW IT WORKS

At peak of flight the Mini-Motor's ejection charge ignites, pushing out the nose cone and parachute (recommended version), or the motor mount ejects itself and a streamer from the rear (alternate version). The rocket then descends safely to Earth, ready to be "prepped" for another flight.

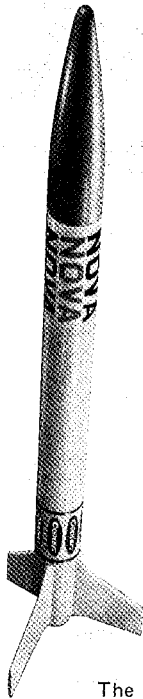

### TOOLS YOU WILL NEED

- Superbond Glue (or "white" glue)
- Fil-Cote (or Sanding Sealer) & Brush
- Fine Sandpaper
- Spray Paint (Enamel)
- Modeling Knife or Scissors
- Pencil

**Centuri**

### MAIN ASSEMBLY INSTRUCTIONS

This "Kustom Kit" may be built in either one of two styles. The easier, and recommended style is shown on this side of the instruction sheet. Tips on building the slightly more challenging alternate version are shown on the reverse side. You must read the steps on this side to familiarize yourself with the basic assembly, even if you plan to build the alternate version.

The nose-ejection parachute version shown here is ideal for typical sport flying.

- 1** To draw guide lines for neatly gluing on fins: Stand the motor tube upright on its fin guide and mark each position on the tube.

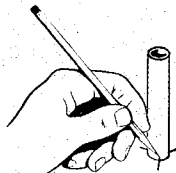
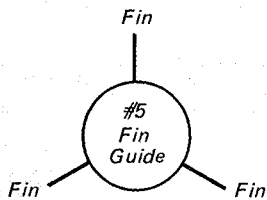

- 2** Find a convenient groove or channel, such as a door jamb or partially open drawer. Extend the marks into straight guide lines the length of the tube. NOTE: Also draw one line on the main body tube (for launch luglets).

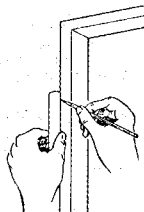

- 3** Remove the pre-cut fins from their sheet carefully, to avoid tearing the balsa. Please notice which edge is the root edge (part that glues to body tube).

Fins will be glued on in the next step. Be sure to position them as shown, and try to have neat alignment.

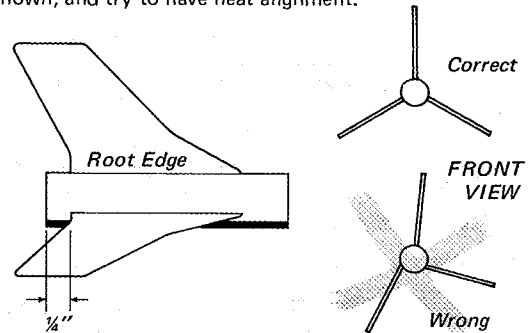

- 4** Use this pre-gluing technique to put your fins on: (A) One at a time, apply glue to the root edge of a fin. (B) Press in place on the fin line drawn on the body tube. (C) Remove the fin, and repeat with remaining fins. Now, apply fresh glue to each fin and re-position on the tube.

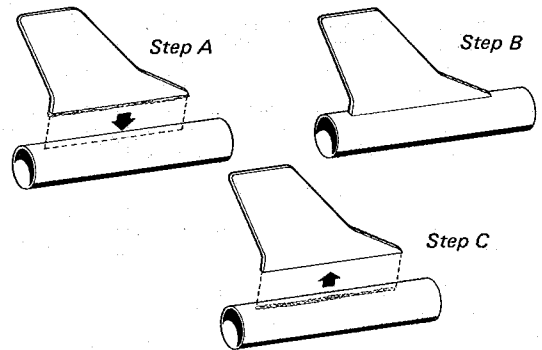

- 5** Proceed with these other steps while fin joints are drying:

Screw the metal screw eye into the center of the nose cone base. Unscrew it and squirt a drop of glue into the hole. Rescrew the eye in place.

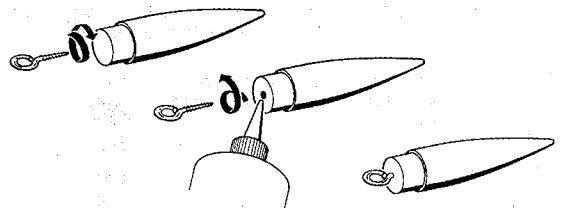

- 6** Tie one end of the shock cord around the heavy paper shock cord fastener (1/2" x 1"). Bend it neatly into a half-circle and apply glue to the entire outside surface.

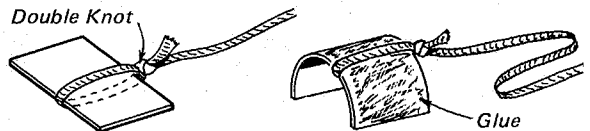

- 13** Sand each fin to a "teardrop" air foil for best performance... resting the fin on the edge of your work table is the easiest way. Apply a glue bead along each fin joint, and smooth into neat "fillets" with your finger.

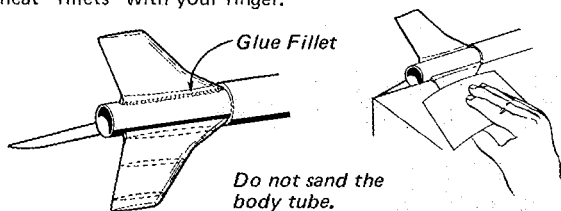

- 14** Paint the fins and nose cone with balsa fillercoat or sanding sealer and allow to dry. Sand lightly with fine sandpaper. Paint and sand again, repeating the process until all grain is filled.

#### CROSS SECTION OF WOOD SURFACE

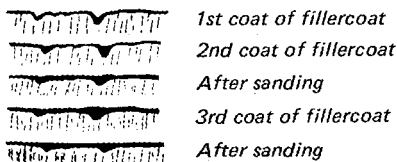

- 15** Choose a paint color which your "decals" will show up well against.

For best painting results, use a spray enamel... it is usually easier, faster and better looking than brushed-on "dope" or enamel. Never use "dope" or lacquer to paint plastic parts.

DO NOT try to paint your model with one heavy coat! Instead give it a couple of quick, light coats first, THEN a finish coat. Let each dry before applying the next.

#### SPRAYING A TYPICAL MODEL ROCKET

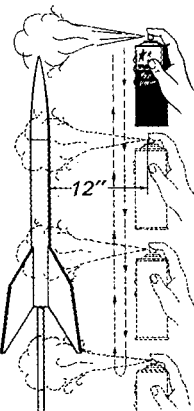

- 16** The pressure-sensitive "decals" may be applied when the paint is completely dry. Use scissors or a modeling knife to cut each piece out of the sheet. The white background of your "decals" will be clear (like scotch tape) when you apply them to your model.

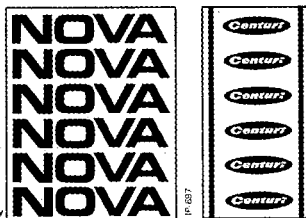

Cut just barely *inside* these guidelines

WASH YOUR HANDS THOROUGHLY BEFORE APPLYING DECALS, or your fingerprints will get the decal glue dirty, and hurt your rocket's appearance.

Wash your hands first!

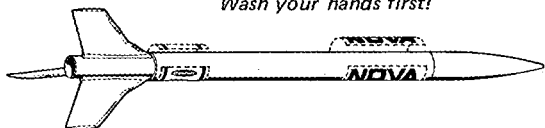

Your NOVA is now complete. Read the LAUNCHING INSTRUCTIONS before trying to fly it.

## ALTERNATE ASSEMBLY TIPS

Tips for building the alternate, more challenging version of this kit are shown below. Please read the main assembly instructions first, if you decide to build this alternate version. The steps shown below are only tips, to be used along with the regular building techniques shown on the other side.

- A** Building this rear-ejection version will provide slightly higher flights... but it is a little more challenging to prep and fly. In this version the ejecting motor pulls the streamer out with itself. We suggest that you not try to use the chute for this version, because rear-ejected chutes tend to rip apart.

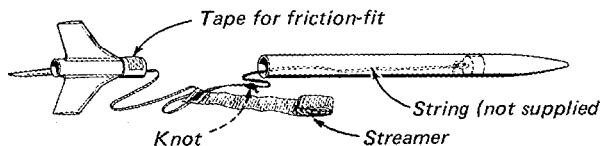

- B** Glue the nose cone in place, after tying the string to the screw eye. You can completely eliminate the nose cone/body tube joint line with careful sanding, and sealing... this will avoid drag and allow for greater altitude.

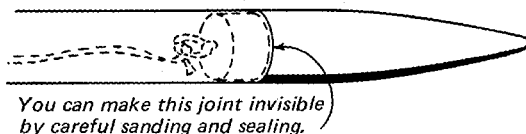

- C** Tie the other end of shock cord into a knot, and wedge it tightly when gluing on the centering ring.

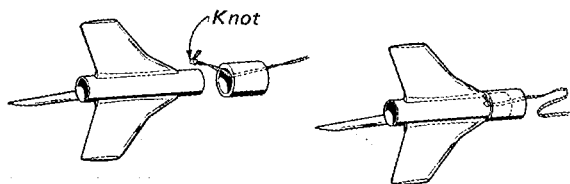

- D** We have supplied more streamer material than you can actually use at one time... Cut off about 4 feet for this kit, and save the rest for repairs and replacement later.

- E** Attach one end of the 4' streamer to the middle of the shock cord with masking tape. Be sure it is on firmly... add a staple if you can.

## LAUNCHING INSTRUCTIONS

Igniters and complete Mini-Motor instructions are included with all Centuri Mini-Motors.

The NOVA can be launched with any of following Mini-Motors.

#### MAXIMUM ALTITUDE CHART

ALTITUDES DEPEND GREATLY ON THE PRECISION OF ASSEMBLY AND SMOOTHNESS OF THE SURFACE FINISH. USE LOWER POWER MOTORS (A, A) FOR FIRST FLIGHTS.

MOTOR	FEET	MOTOR	FEET
¼A4-2M	250	A4-4M	800
¼A4-3M	450	B4-5M	1400

Centuri KM-4 Nova  
Fin Templates  
Make 3 From 3/32" Balsa

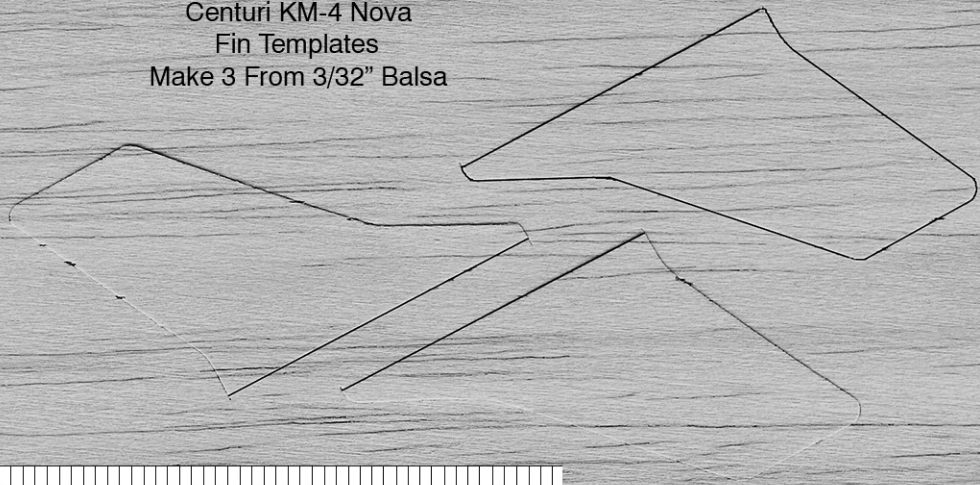

NOVA  
NOVA  
NOVA  
NOVA  
NOVA  
NOVA

IP-697

*Centuri*  
*Centuri*  
*Centuri*  
*Centuri*  
*Centuri*  
*Centuri*

